

Annexe 1



Cet intercalaire doit obligatoirement être inséré
devant la page de garde d'un manuel de vol en
langue anglaise

AVERTISSEMENT

Le présent document en langue anglaise est le manuel de vol approuvé par l'Agence européenne de la sécurité aérienne.

En application des dispositions de l'arrêté du 24 juillet 1991 relatif aux conditions d'utilisation des aéronefs civils en aviation générale (« Un vol ne peut être entrepris que si, d'une part les membres d'équipage sont familiarisés avec l'aéronef et son équipement de bord, notamment le matériel de sécurité-sauvetage et les systèmes spéciaux, et d'autre part ont une connaissance pratique de son manuel de vol ou des documents acceptés comme équivalents. »),

Nul ne peut utiliser l'aéronef avec ce seul document s'il n'a pas une connaissance suffisante de la langue anglaise.

A défaut, il appartient au propriétaire ou à l'exploitant de l'aéronef de se procurer une traduction de ce document sous sa responsabilité.

Référence : Instruction du 13/11/2009 relative à la langue des manuels de vol

ARCHER III

PA-28-181

SN 2843001 AND UP

PILOT'S OPERATING HANDBOOK

AND

FAA APPROVED AIRPLANE FLIGHT MANUAL

AIRPLANE
SERIAL NO. 2843426

AIRPLANE
REGIST. NO. **F HMCI**

PA-28-181

REPORT: VB-1611 FAA APPROVED BY:

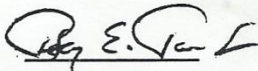

PETER E. PECK
D.O.A. NO. SO-1
THE NEW PIPER AIRCRAFT, INC.
VERO BEACH, FLORIDA

DATE OF APPROVAL:
JULY 12, 1995

FAA APPROVED IN NORMAL AND UTILITY CATEGORIES BASED ON CAR 3. THIS HANDBOOK INCLUDES THE MATERIAL REQUIRED TO BE FURNISHED TO THE PILOT BY CAR 3 AND CONSTITUTES THE APPROVED AIRPLANE FLIGHT MANUAL AND MUST BE CARRIED IN THE AIRPLANE AT ALL TIMES.



Per-Olov Brink
Luftfartsingenjör
LUFTFARTSVERKET



WARNING

EXTREME CARE MUST BE EXERCISED TO LIMIT THE USE OF THIS HANDBOOK TO APPLICABLE AIRCRAFT. THIS HANDBOOK IS VALID FOR USE WITH THE AIRPLANE IDENTIFIED ON THE FACE OF THE TITLE PAGE. SUBSEQUENT REVISIONS SUPPLIED BY PIPER MUST BE PROPERLY INSERTED.

Published by
PUBLICATIONS DEPARTMENT
Issued: July 12, 1995
© 1995 THE NEW PIPER AIRCRAFT, INC.
All Rights Reserved



APPLICABILITY

Application of this handbook is limited to the specific Piper PA-28-181 model airplane designated by serial number and registration number on the face of the title page of this handbook.

This handbook cannot be used for operational purposes unless kept in a current status.

REVISIONS

The information compiled in the Pilot's Operating Handbook, with the exception of the equipment list, will be kept current by revisions distributed to the airplane owners. The equipment list was current at the time the airplane was licensed by the manufacturer and thereafter must be maintained by the owner.

Revision material will consist of information necessary to update the text of the present handbook and/or to add information to cover added airplane equipment.

I. Revisions

Revisions will be distributed whenever necessary as complete page replacements or additions and shall be inserted into the handbook in accordance with the instructions given below:

1. Revision pages will replace only pages with the same page number.
2. Insert all additional pages in proper numerical order within each section.
3. Page numbers followed by a small letter shall be inserted in direct sequence with the same common numbered page.

II. Identification of Revised Material

Revised text and illustrations shall be indicated by a black vertical line along the outside margin of the page, opposite revised, added or deleted material. A line along the outside margin of the page opposite the page number will indicate that an entire page was added.

Black lines will indicate only current revisions with changes and additions to or deletions of existing text and illustrations. Changes in capitalization, spelling, punctuation or the physical location of material on a page will not be identified.

ORIGINAL PAGES ISSUED

The original pages issued for this handbook prior to revision are given below:

Title, ii through viii, 1-1 through 1-18, 2-1 through 2-10, 3-1 through 3-16, 4-1 through 4-28, 5-1 through 5-34, 6-1 through 6-12, 7-1 through 7-26, 8-1 through 8-20, 9-1 through 9-14, 10-1 through 10-2.

PILOT'S OPERATING HANDBOOK LOG OF REVISIONS

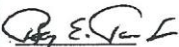

Current Revisions to the PA-28-181 ARCHER III Pilot's Operating Handbook,
REPORT: VB-1611 issued July 12, 1995.

Revision Number and Code	Revised Pages	Description of Revisions	FAA Approval Signature and Date
Rev. 1 (PR961118)	v	Added Rev. 1 to L of R page.	 Peter E. Peck <u>Nov. 18, 1996</u> Date
	4-27	Revised para. 4.43.	
	5-3	Revised para. 5.5 (a)(6).	
	5-7	Revised para. 5.5 (g)(1)	
	5-26	Revised fig. 5-27.	
	5-27	Revised fig. 5-27a.	
	5-28	Revised fig. 5-29.	
	5-29	Revised fig. 5-29a.	
	8-14	Revised para. 8.21.(c)	
Rev. 2 (PR970403)	v	Added Rev. 2 to L of R page.	 Peter E. Peck <u>APRIL 3, 1997</u> Date
	5-4	Revised para. 5.5 (b)(5).	
	5-28	Revised fig. 5-29.	
	5-29	Revised fig. 5-29a.	
	5-32	Revised fig. 5-35.	
	5-33	Revised fig. 5-37.	
	7-i	Rev. TOC.	
	7-27	Added para. 7.39.	
	7-28	Added blank page.	
	9-15	Added Supplement 4	
	thru	Bendix/King KLN89 (B)	
	9-26	GPS Nav. System	
	9-27	Added Supplement 5	
	thru	Bendix/King KX 155A	
9-38	Comm/Nav System		
9-39	Added Supplement 6		
	9-40	Added blank page.	

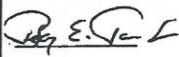
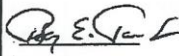
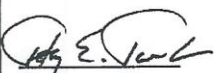

PILOT'S OPERATING HANDBOOK LOG OF REVISIONS

Revision Number and Code	Revised Pages	Description of Revisions	FAA Approval Signature and Date
Rev. 3 (PR980312)	vi 5-18 9-39 9-40	Added Rev. 3 to L of R page. Revised fig. 5-15. Revised header & title. Revised header.	 Peter E. Peck <u>March 12, 1998</u> Date
Rev. 4 (PR980331)	vi 5-14 5-15 5-16 5-17 5-18 5-19 5-20 5-30 5-32 5-33	Added Rev. 4 to L of R page. Revised Fig. 5-7. Revised Fig. 5-9. Revised Fig. 5-11. Revised Fig. 5-13. Revised Fig. 5-15. Revised Fig. 5-17. Revised Fig. 5-19. Revised Fig. 5-31. Revised Fig. 5-35. Revised Fig. 5-37.	 Peter E. Peck <u>March 31, 1998</u> Date
Rev. 5 (PR981106)	vi 4-10 4-11 4-22 5-13 5-15 5-17 5-31 9-i 9-41 thru 9-48	Added Rev. 5 to L of R page. Revised para. 4.5. Revised para. 4.5. Revised para. 4.23. Revised Fig. 5-5. Revised Fig. 5-9. Revised Fig. 5-13. Revised Fig. 5-33. Revised T of C. Added Supplement 7 - Garmin GNS 430 Nav/Comm.	 Peter E. Peck <u>Nov. 6, 1998</u> Date

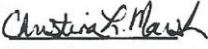
PILOT'S OPERATING HANDBOOK LOG OF REVISIONS

Revision Number and Code	Revised Pages	Description of Revisions	FAA Approval Signature and Date
Rev. 6 (PR981218)	vi-a vi-b 9-i 9-49 9-50	Added page. Added page. Revised T of C. Added page. Added page.	 Peter E. Peck <u>Dec. 18, 1998</u> Date
Rev. 7 (PR991206)	vi-a 5-23 9-i 9-51 thru 9-52	Added Rev. 7 to L of R. Revised Fig. 5-20b. Revised T of C. Added pages and Supplement 9.	 Christina L. Marsh <u>Dec. 6, 1999</u> Date
Rev. 8 (PR000714)	vi-a 9-i 9-47 9-53 thru 9-58 9-59 thru 9-62 9-63 thru 9-70	Added Rev. 8 to L of R. Revised T of C. Revised Section 4. Added pages and Supplement 10. Added pages and Supplement 11. Added pages and Supplement 12.	 Christina L. Marsh <u>July 14, 2000</u> Date
Rev. 9 (PR010102)	vi-a vi-b 9-i 9-71 thru 9-80	Added Rev. 9 to L of R. Added Rev. 9 to L of R. Revised T of C. Added pages and Supplement 13.	

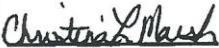

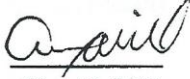
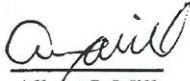
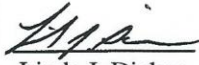
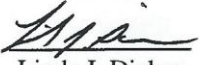

PILOT'S OPERATING HANDBOOK LOG OF REVISIONS

Revision Number and Code	Revised Pages	Description of Revisions	FAA Approval Signature and Date
Rev. 9 (PR010102) continued	9-81 thru 9-82 9-83 thru 9-88 9-89 thru 9-94 9-95 thru 9-98	Added pages and Supplement 14. Added pages and Supplement 15. Added pages and Supplement 16. Added pages and Supplement 17.	<div style="text-align: center;">  <u>Christina L. Marsh</u> Christina L. Marsh <u>Jan. 2, 2001</u> Date </div>
Rev. 10 (PR020415)	vi-b 3-4 4-7 4-8 4-9 4-18 4-19	Added Rev. 10 to L of R. Revised para. 3.5. Revised para. 4.5. Revised para. 4.5. Revised para. 4.5. Revised para. 4.13. Revised para. 4.13.	<div style="text-align: center;">  <u>Albert J. Mill</u> Albert J. Mill <u>April 15, 2002</u> Date </div>

PILOT'S OPERATING HANDBOOK LOG OF REVISIONS

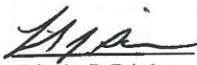
Revision Number and Code	Revised Pages	Description of Revisions	FAA Approval Signature and Date
Rev. 11 (PR040105) continued	8-1b	Added page and moved info. from pages 8-1 and 8-2.	 <u>Albert J. Mill</u> <u>Jan. 5, 2004</u> Date
	8-2	Moved info. to page 8-1b and revised para. 8.3.	
	9-i	Revised T of C.	
	9-99 thru	Added pages and Supplement 18.	
	9-102		
Rev. 12 (PR040614)	vi-c	Added Rev. 12 to L of R.	 <u>Albert J. Mill</u> June 14, 2004
	9-i	Revised T of C.	
	9-103 thru	Added pages and Supplement 19.	
	9-110		
Rev. 13 (PR041007)	vi-c	Added Rev. 13 to L of R.	 <u>Linda J. Dicken</u> October 7, 2004
	9-i	Revised T of C.	
	9-111 thru	Added pages and Supplement 20.	
	9-128		
	9-129 thru	Added pages and Supplement 21.	
	9-132		
Rev. 14 (PR050912)	vi-c	Added Rev. 14 to L of R.	 <u>Linda J. Dicken</u> Sept. 12, 2005
	9-i	Revised T of C.	
	9-111 thru	Revised Supplement 20.	
	9-138		
	9-139 thru	Revised page numbers.	
	9-142		
	9-143 thru	Added pages and Supplement 22.	
	9-152		

PILOT'S OPERATING HANDBOOK LOG OF REVISIONS

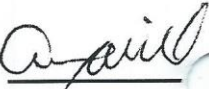
Revision Number and Code	Revised Pages	Description of Revisions	FAA Approval Signature and Date
Rev. 15 (PR051128)	vi-d 9-116 9-119 9-123	Added Rev. 15 to L of R. Revised Section 3. Revised Section 3. Revised Section 3.	 Linda J. Dicken Nov. 28, 2005
Rev. 16 (PR060109)	vi-d 9-i 9-111 thru 9-138	Added Rev. 16 to L of R. Revised T of C. Revised Supplement 20.	 Linda J. Dicken Jan. 9, 2006
Rev. 17 (PR060214)	vi-d 9-ii 9-116 9-119 9-120 9-123 9-124 9-153 thru 9-188	Added Rev. 17 to L of R. Revised T of C. Revised Section 3. Revised Section 3. Revised Section 3. Revised Section 3. Revised Section 3. Added pages and Supplement 23.	 Linda J. Dicken Feb. 14, 2006
Rev. 18 (PR060411)	vi-d 9-131 9-179	Added Rev. 18 to L of R. Revised Section 7A. Revised Section 7A.	 Linda J. Dicken April 11, 2006
Rev. 19 (PR070129)	vi-d 8-20	Added Rev. 19 to L of R. Revised para. 8.29.	 Linda J. Dicken Jan. 29, 2007
Rev. 20 (PR080411)	vi-d 9-155 9-164 9-178 9-186	Added Rev. 20 to L of R. Revised Supp 23, Section 1. Revised Supp 23, Section 3. Revised Supp 23, Section 4. Revised Supp 23, Section 7B.	 Albert J. Mill April 11, 2008

PILOT'S OPERATING HANDBOOK LOG OF REVISIONS

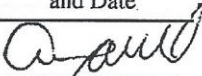
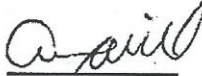
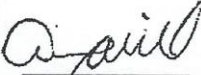
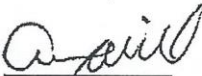
Revision Number and Code	Revised Pages	Description of Revisions	FAA Approved Signature and Date
Rev. 21 (PR081015)	v-e,f vi-e 9-ii 9-189 thru 9-202	Added new pages to L of R. Added Rev. 21 to L of R. Added Supplements 24 and 25 to Section 9 TOC. Added Supplements 24 and 25 to Section 9.	 Albert J. Mill Oct. 15, 2008
Rev. 22 (PR090615)	vi-e 4-7 4-17 8-1b 9-112 9-154	Added Rev. 22 to L of R. Revise Note in Para. 4.5. Revise Note in Para. 4.9. Revised text in Para. 8.1. Revised text in Para. 8.1. Revised text in Para. 8.1.	 Albert J. Mill June 15, 2009
Rev. 23 (PR100205)	vi-e 4-23 7-13 7-15 9-ii 9-203 thru 9-206	Added Rev. 23 to L of R. Revised Para. 4.27. Revised Para. 7.19. Revised callouts for Instrument Panel. Added Supplements 26 and 27 to TOC. Added pages.	 Albert J. Mill February 5, 2010
Rev. 24 (PR100729)	vi-e,f 2-8 7-25 7-26 9-ii 9-205 9-206 9-207 thru 9-216	Added Rev. 24 to L of R. Added Note to Para. 2.25. Revised Para. 7.37. Revised Para. 7.37. Revised T.O.C. Revised Supplement 27. Revised Supplement 27. Added pages.	 Albert J. Mill July 29, 2010

ISSUED: JULY 12, 1995
 REVISED: JULY 29, 2010

REPORT: VB-1611
 vi-e

TABLE OF CONTENTS

SECTION 1	GENERAL
SECTION 2	LIMITATIONS
SECTION 3	EMERGENCY PROCEDURES
SECTION 4	NORMAL PROCEDURES
SECTION 5	PERFORMANCE
SECTION 6	WEIGHT AND BALANCE
SECTION 7	DESCRIPTION AND OPERATION OF THE AIRPLANE AND ITS SYSTEMS
SECTION 8	AIRPLANE HANDLING, SERVICING AND MAINTENANCE
SECTION 9	SUPPLEMENTS
SECTION 10	OPERATING TIPS

THIS PAGE INTENTIONALLY LEFT BLANK

TABLE OF CONTENTS
SECTION 1
GENERAL

Paragraph No.	Page No.
1.1 Introduction	1-1
1.3 Engines	1-3
1.5 Propellers	1-3
1.7 Fuel	1-3
1.9 Oil	1-4
1.11 Maximum Weights	1-4
1.13 Standard Airplane Weights.....	1-4
1.15 Baggage Space	1-5
1.17 Specific Loadings.....	1-5
1.19 Symbols, Abbreviations and Terminology	1-6
1.21 Conversion Factors.....	1-12

THIS PAGE INTENTIONALLY LEFT BLANK

SECTION 1
GENERAL

1.1 INTRODUCTION

This Pilot's Operating Handbook is designed for maximum utilization as an operating guide for the pilot. It includes the material required to be furnished to the pilot by F.A.R./C.A.R. It also contains supplemental data supplied by the airplane manufacturer.

This handbook is not designed as a substitute for adequate and competent flight instruction, knowledge of current airworthiness directives, applicable federal air regulations or advisory circulars. It is not intended to be a guide for basic flight instruction or a training manual and should not be used for operational purposes unless kept in a current status.

Assurance that the airplane is in an airworthy condition is the responsibility of the owner. The pilot in command is responsible for determining that the airplane is safe for flight. The pilot is also responsible for remaining within the operating limitations as outlined by instrument markings, placards, and this handbook.

Although the arrangement of this handbook is intended to increase its in-flight capabilities, it should not be used solely as an occasional operating reference. The pilot should study the entire handbook to familiarize himself with the limitations, performance, procedures and operational handling characteristics of the airplane before flight.

The handbook has been divided into numbered (arabic) sections, each provided with a "finger-tip" tab divider for quick reference. The limitations and emergency procedures have been placed ahead of the normal procedures, performance and other sections to provide easier access to information that may be required in flight. The "Emergency Procedures" Section has been furnished with a red tab divider to present an instant reference to the section. Provisions for expansion of the handbook have been made by the deliberate omission of certain paragraph numbers, figure numbers, item numbers and pages noted as being intentionally left blank.

SECTION 1
GENERAL

PA-28-181, ARCHER III

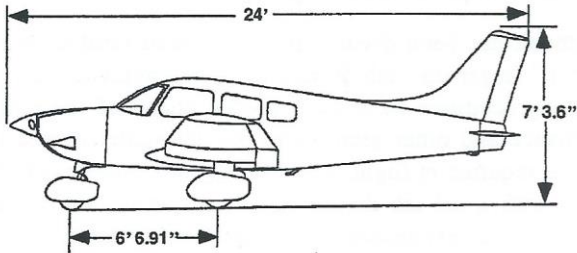
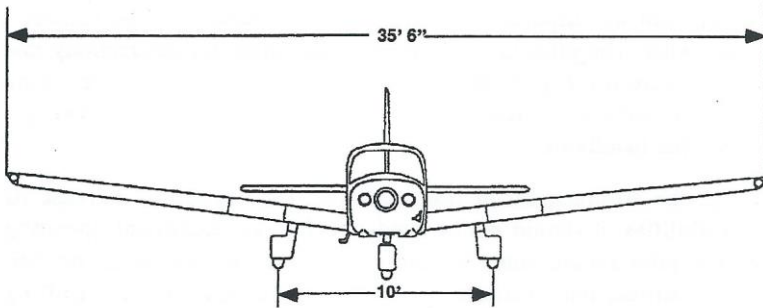
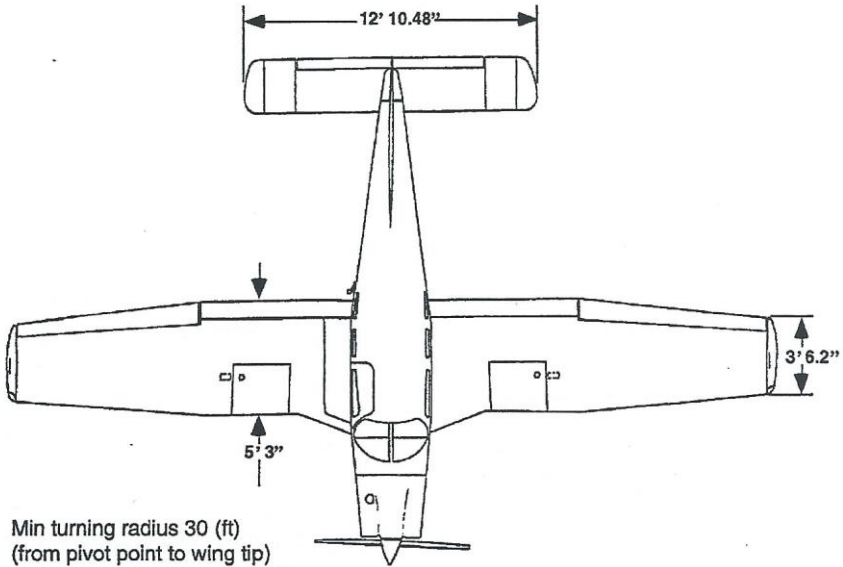

THREE VIEW

1.3 ENGINES

(a) Number of Engines	1
(b) Engine Manufacturer	Lycoming
(c) Engine Model Number	O-360-A4M
(d) Takeoff Power (BHP)	180
(e) Takeoff Power Engine Speed (RPM)	2700
(f) Bore (inches)	5.125
(g) Stroke (inches)	4.375
(h) Displacement (cubic inches)	361.0
(i) Compression Ratio	8.5:1
(j) Engine Type	Four Cylinder, Direct Drive, Horizontally Opposed, Air Cooled

1.5 PROPELLERS

(a) Number of Propellers	1
(b) Propeller Manufacturer	Sensenich
(c) Model	76EM8S14-0-62
(d) Number of Blades	2
(e) Propeller Diameter (inches)	
(1) Maximum	76
(2) Minimum	76
(f) Propeller Type	Fixed Pitch

1.7 FUEL

AVGAS ONLY

(a) Fuel Capacity (U.S. gal.) (total)	50
(b) Usable Fuel (U.S. gal.) (total)	48
(c) Fuel	
(1) Minimum Octane	100 Green or 100LL Blue Aviation Grade
(2) Alternate Fuel	Refer to latest issue of Lycoming Instruction No. 1070.

**SECTION 1
GENERAL**

PA-28-181, ARCHER III

1.9 OIL

- | | | |
|---|-----------|---|
| (a) Oil Capacity (U.S. quarts) | | 8 |
| (b) Oil Specification | | Refer to latest issue
of Lycoming Service
Instruction 1014. |
| (c) Oil Viscosity per Average Ambient
Temp. for Starting | | |
| | Single | Multi |
| (1) Above 60°F | S.A.E. 50 | S.A.E. 40 or 50 |
| (2) 30°F to 90°F | S.A.E. 40 | S.A.E. 40 |
| (3) 0°F to 70°F | S.A.E. 30 | S.A.E. 40 or
20W-30 |
| (4) Below 10°F | S.A.E. 20 | S.A.E. 20W-30 |

1.11 MAXIMUM WEIGHTS

	Normal	Utility
(a) Maximum Ramp Weight (lbs.)	2558	2138
(b) Maximum Takeoff Weight (lbs.)	2550	2130
(c) Maximum Landing Weight (lbs.)	2550	2130
(d) Maximum Weights in Baggage Compartment (lbs.)	200	0

1.13 STANDARD AIRPLANE WEIGHTS

Refer to Figure 6-5 for the Standard Empty Weight and the Useful Load.

1.15 BAGGAGE SPACE

(a) Compartment Volume (cubic feet)	24
(b) Entry Width (inches)	22
(c) Entry Height (inches)	20

1.17 SPECIFIC LOADINGS

(a) Wing Loading (lbs. per sq. ft.)	15.0
(b) Power Loading (lbs. per hp)	14.2

1.19 SYMBOLS, ABBREVIATIONS AND TERMINOLOGY

The following definitions are of symbols, abbreviations and terminology used throughout the handbook and those which may be of added operational significance to the pilot.

(a) General Airspeed Terminology and Symbols

CAS	Calibrated Airspeed means the indicated speed of an aircraft, corrected for position and instrument error. Calibrated airspeed is equal to true airspeed in standard atmosphere at sea level.
KCAS	Calibrated Airspeed expressed in "Knots."
GS	Ground Speed is the speed of an airplane relative to the ground.
IAS	Indicated Airspeed is the speed of an aircraft as shown on the airspeed indicator when corrected for instrument error. IAS values published in this handbook assume zero instrument error.
KIAS	Indicated Airspeed expressed in "Knots."
TAS	True Airspeed is the airspeed of an airplane relative to undisturbed air which is the CAS corrected for altitude, temperature and compressibility.
VA	Maneuvering Speed is the maximum speed at which application of full available aerodynamic control will not overstress the airplane.
VFE	Maximum Flap Extended Speed is the highest speed permissible with wing flaps in a prescribed extended position.

Vne/Mne	Never Exceed Speed or Mach Number is the speed limit that may not be exceeded at any time.
Vno	Maximum Structural Cruising Speed is the speed that should not be exceeded except in smooth air and then only with caution.
Vs	Stalling Speed or the minimum steady flight speed at which the airplane is controllable.
Vso	Stalling Speed or the minimum steady flight speed at which the airplane is controllable in the landing configuration.
Vx	Best Angle-of-Climb Speed is the airspeed which delivers the greatest gain of altitude in the shortest possible horizontal distance.
Vy	Best Rate-of-Climb Speed is the airspeed which delivers the greatest gain in altitude in the shortest possible time.
(b)	Meteorological Terminology
ISA	International Standard Atmosphere in which: The air is a dry perfect gas; The temperature at sea level is 15° Celsius (59° Fahrenheit); The pressure at sea level is 29.92 inches Hg (1013.2 mb); The temperature gradient from sea level to the altitude at which the temperature is -56.5°C (-69.7°F) is -0.00198C (-0.003564°F) per foot and zero above that altitude.
OAT	Outside Air Temperature is the free air static temperature, obtained either from inflight temperature indications or ground meteorological sources, adjusted for instrument error and compressibility effects.

Indicated Pressure Altitude The number actually read from an altimeter when the barometric subscale has been set to 29.92 inches of mercury (1013.2 millibars).

Pressure Altitude Altitude measured from standard sea-level pressure (29.92 in. Hg) by a pressure or barometric altimeter. It is the indicated pressure altitude corrected for position and instrument error. In this handbook, altimeter instrument errors are assumed to be zero.

Station Pressure Actual atmospheric pressure at field elevation.

Wind The wind velocities recorded as variables on the charts of this handbook are to be understood as the headwind or tailwind components of the reported winds.

(c) Power Terminology

Takeoff Power Maximum power permissible for takeoff.

Maximum Continuous Power Maximum power permissible continuously during flight.

(d) Engine Instruments

EGT Gauge Exhaust Gas Temperature Gauge

(e) Airplane Performance and Flight Planning Terminology

Climb Gradient	The demonstrated ratio of the change in height during a portion of a climb, to the horizontal distance traversed in the same time interval.
Demonstrated Crosswind Velocity (Demo. X-Wind)	The demonstrated crosswind velocity is the velocity of the crosswind component for which adequate control of the airplane during takeoff and landing was actually demonstrated during certification tests.
Accelerate-Stop Distance	The distance required to accelerate an airplane to a specified speed and, assuming failure of an engine at the instant that speed is attained, to bring the airplane to a stop.
Route Segment	A part of a route. Each end of that part is identified by: (1) a geographical location; or (2) a point at which a definite radio fix can be established.

(f) Weight and Balance Terminology

Reference Datum	An imaginary vertical plane from which all horizontal distances are measured for balance purposes.
Station	A location along the airplane fuselage usually given in terms of distance from the reference datum.
Arm	The horizontal distance from the reference datum to the center of gravity (C.G.) of an item.

Moment	The product of the weight of an item multiplied by its arm. (Moment divided by a constant is used to simplify balance calculations by reducing the number of digits.)
Center of Gravity (C.G.)	The point at which an airplane would balance if suspended. Its distance from the reference datum is found by dividing the total moment by the total weight of the airplane.
C.G. Arm	The arm obtained by adding the airplane's individual moments and dividing the sum by the total weight.
C.G. Limits	The extreme center of gravity locations within which the airplane must be operated at a given weight.
Usable Fuel	Fuel available for flight planning.
Unusable Fuel	Fuel remaining after a runout test has been completed in accordance with governmental regulations.
Standard Empty Weight	Weight of a standard airplane including unusable fuel, full operating fluids and full oil.
Basic Empty Weight	Standard empty weight plus optional equipment.
Payload	Weight of occupants, cargo and baggage.
Useful Load	Difference between takeoff weight, or ramp weight is applicable, and basic empty weight.
Maximum Ramp Weight	Maximum weight approved for ground maneuver. (It includes weight of start, taxi and run up fuel.)

Maximum
Takeoff Weight

Maximum weight approved for the start of
the takeoff run.

Maximum
Landing Weight

Maximum weight approved for the landing
touchdown.

Maximum Zero
Fuel Weight

Maximum weight exclusive of usable fuel.

1.21 CONVERSION FACTORS

MULTIPLY	BY	TO OBTAIN
centimeters (cm)	0.032808	feet (ft.)
	0.3937	inches (in.)
	0.01	meters (m)
centimeters of mercury at 0° C (cm Hg)	13.3322	hectopascals (hPa)
	.3937	inches of mercury (in. Hg)
	27.85	pounds / sq. foot (Ibf./ft ²)
	0.1934	pounds / sq. inch (Ibf./in ²)
cubic centimeters (cm ³)	3.531x10 ⁻⁵	cubic feet (ft ³)
	0.06102	cubic inches (in ³)
	0.001	Liters (l)
	0.03381	fluid ounces (fl. oz)
	2.642x10 ⁻⁴	U.S. gallons (U.S. gal)
cubic feet (ft ³)	28317	cubic centimeters (cm ³)
	7.481	U.S. gallons (U.S. gal)
	1728	cubic inches (in ³)
	28.32	liters (l)
	0.028317	cubic meters (m ³)
cubic inches (in ³)	16.39	cubic centimeters (cm ³)
	5.787x10 ⁻⁴	cubic feet (ft ³)
	4.329x10 ⁻³	U.S. gallons (U.S. gal)
	0.01639	liters (l)
	1.639x10 ⁻⁵	cubic meters (m ³)
	0.5541	fluid ounces (fl. oz)
cubic meters (m ³)	0.01732	U.S. quarts (U.S. qt)
	35.3147	cubic feet (ft ³)
	264.2	U.S. gallons (U.S. gal)
	61024	cubic inches (in ³)
	1000000	liters (l)
degrees arc. (deg)	0.01745	radians
degrees arc per second (deg / sec)	0.01745	radians per second
	0.166667	revolutions per second (rpm)

MULTIPLY	BY	TO OBTAIN
drams, fluid (dr. fl.)	3.697×10^{-3}	liters (l)
	3.697×10^{-6}	cubic meters (m ³)
	0.125	fluid ounces (fl. oz)
feet (ft)	30.48	centimeters (cm)
	12	inches
	0.3048	meters (m)
	1.8939×10^{-4}	miles (mi)
	1.6458	nautical miles (NM)
	0.0606061	rods
feet per minute (ft / min)	0.01829	kilometers per hour (km / hr)
	9.8716×10^{-3}	knots (kt)
	0.00508	meters per second (m / s)
	0.01136	miles per hour (mph)
feet per second (ft / sec)	1.097	kilometers per hour (km / hr)
	0.5921	knots (kt)
	0.3048	meters per second (m / s)
	0.6818	miles per hour (mph)
foot-pounds (ft.-lbs.)	3.2383×10^{-4}	kilocalorie (kcal)
	1.3558	joules (j)
	14.5939	newton-meters (n-m)
foot-pound per minute (ft-lbs/ min)	3.03×10^{-5}	horse power (hp)
	81.348	joules per minute (j / min)
foot-pound per second (ft-lbs/ sec)	1.818×10^{-5}	horse power (hp)
	1.3558	joules per second (j / sec)
gallons, imperial (imperial gal)	4.546×10^{-3}	cubic centimeters (cm ³)
	1.201	U.S. gallon (U.S. gal)
	277.4	cubic inches (in ³)
	4.546	liters (l)
gallons, U.S. dry (U.S. gal dry)	4.405×10^{-3}	cubic meters (m ³)
	0.1556	cubic feet (ft ³)
	1.164	U.S. gallon (U.S. gal)
	268.8	cubic inches (in ³)
	4.405	liters (l)

**SECTION 1
GENERAL**

PA-28-181, ARCHER III

MULTIPLY	BY	TO OBTAIN
gallons, U.S. Liquid (U.S. gal)	3785.4	cubic centimeters (cm ³)
	0.1337	cubic feet (ft ³)
	0.83268	imperial gallons (imperial gal)
	231	cubic inches (in ³)
	3.785	liters (l)
hectares (ha)	3.785x10 ⁻³	cubic meters (m ³)
	128	fluid ounces (fl. oz)
	2.471	acres
	107639	square feet (ft ²)
	10000	square meters (m ²)
horsepower (hp)	33000	foot-pound per minute (ft-lbs / min)
	550	foot-pound per second (ft-lbs / sec)
	745.7	joules per second (j / sec)
	1.014	metric horsepower (metric hp)
	8.026x10 ³	newton-meters per second (n-m / sec)
horsepower, metric	0.9863	horsepower (hp)
	735.484	joules per second (j / sec)
	8.138x10 ³	newton-meters per second (n-m / sec)
inches (in)	2.54	centimeters (cm)
	0.08333	feet (ft)
	0.0254	meters (m)
inches of mercury	25.4	millimeters (mm)
	0.033421	atmospheres (atm)
	2.54	centimeters of mercury (cm Hg)
	33.8639	hectopascals (hPa)
	70.73	pounds per square foot (lbf / ft ²)
	0.4912	pounds per square inch lbf / in ²)
	25.4	millimeters mercury (mm Hg)

MULTIPLY	BY	TO OBTAIN
kilometers (km)	1×10^{-5}	centimeter (cm)
	3280.8	feet (ft)
	0.6214	miles (mi)
	0.53996	nautical miles (nm)
	58.68	feet per minute (ft / min)
kilometers per hour	0.9113	feet per second (ft / sec)
	0.53996	knots (kt)
	16.67	meters per minute (m / min)
	0.27778	meters per second (m / sec)
	0.6214	miles per hour (mph)
knots (kt)	1.689	feet per second (ft / sec)
	1.852	kilometer per hour (km / hr)
	51.48	meter per second (m / sec)
	1	nautical mile per hour (nautical mph)
		statute mile per hour (statute mph)
liters (l)	1000	cubic centimeter (cm ³)
	0.03531	cubic feet (ft ³)
	0.22	imperial gallons (imperial gal)
	0.264172	U.S. gallons (U.S. gal)
	61.02	cubic inches (in ³)
	0.001	cubic meter (m ³)
	33.814	fluid ounces (fl. oz.)
	1.05669	U. S. quart (qt)
liters per second (l / sec)	2.12	cubic feet per minute (ft ³ / min)
meters (m)	3.28084	feet
	39.37	inches
	6.214×10^{-4}	miles (mi)
	5.3996×10^{-4}	nautical mile (nm)
	0.198838	rod
meters per minute (m / min)	0.06	kilometers per hour (km / hr)
	116.6307	knots (kt)

**SECTION 1
GENERAL**

PA-28-181, ARCHER III

MULTIPLY	BY	TO OBTAIN
meters per second (m/sec)	196.8504	feet per minute (ft / min)
	3.280840	feet per second (ft / sec)
	3.6	kilometers per hour (km / hr)
miles, statute(mi)	1.94384	knots (kt)
	2.237	miles per hour (mph)
	5280	feet (ft)
	1609.3	meters (m)
	1.6093	kilometers (km)
miles per hour (mph)	0.8684	nautical miles (nm)
	88	feet per minute (ft / min)
	1.467	feet per second (ft / sec)
	0.8684	knots (kt)
	0.447	meters per second (m / sec)
miles per hour squared (mi / hr ²)	1.6093	kilometer per hour
	2.151	feet per second squared (ft / sec ²)
	0.44704	meter per second squared (m / sec ²)
millibars	1.0	hectopascals (hPa)
millimeters of mercury at 0° C (mm Hg)	0.02953	inches of mercury (in Hg)
	1.3332	hectopascals (hPa)
nautical miles (nm)	0.03937	inches of mercury (in Hg)
	6080	feet (ft)
	1.852	kilometers (km)
	1852	meters (m)
	1.1516	statute miles (mi)
fluid ounces (fl. oz)	29.57	cubic centimeters (cm ³)
	8	fluid drams (fl dr)
	0.0078	U.S. gallons (U.S. gal)
	1.805	cubic inches (in ³)
	0.0296	liters (l)
pounds per square foot (psf or lbs / ft ²)	2.9574x10 ⁻⁵	cubic meters (m ³)
	0.1414	inches of mercury (in Hg)
	47.880	newtons per square meter (n / m ²)

MULTIPLY	BY	TO OBTAIN
pounds per square inch (lbs/ in ²)	68.9475	millibar (mb)
	5.1715	centimeter of mercury (cm Hg)
	2.036	inches of mercury (in Hg)
quart, U.S. (qt)	57.749	cubic inches (in ³)
	0.94635	liters (l)
	9.46353x10 ⁻⁴	cubic meters (m ³)
radians	57.3	degrees arc (deg)
	0.1592	revolutions (rev)
radians per second	57.3	degrees per second (deg /sec)
	9.549	revolutions per minute (rpm)
	360	degrees (deg)
revolutions	6.283	radians
	6	deg per second (deg / sec)
revolutions per minute (rpm)	0.1047	radians per second (r / sec)
	16.5	feet (ft)
	5.029	meters (m)
rod	0.001076	square feet (ft ²)
	0.155	square inches (in ²)
square centimeters (cm ²)	0.0001	square meters (m ²)
	929	square centimeters (cm ²)
	144	square inches (in ²)
square feet (ft ²)	0.092903	square meters (m ²)
	6.4516	square centimeters (cm ²)
	0.006944	square feet (ft ²)
square inches (in ²)	6.4516x10 ⁻⁴	square meters (m ²)
	1000000	square meters (m ²)
	0.3861	square miles (mi ²)
square kilometers (km ²)	10.76391	square feet (ft ²)
	0.0001	hectars (ha)
square meters (m ²)	2589988	square meters (m ²)
	2.59	square kilometers (km ²)

THIS PAGE INTENTIONALLY LEFT BLANK

TABLE OF CONTENTS
SECTION 2
LIMITATIONS

Paragraph No.	Page No.
2.1 General	2-1
2.3 Airspeed Limitations	2-1
2.5 Airspeed Indicator Markings.....	2-2
2.7 Power Plant Limitations	2-3
2.9 Power Plant Instrument Markings.....	2-4
2.11 Weight Limits	2-4
2.13 Center of Gravity Limits	2-5
2.15 Maneuver Limits	2-6
2.17 Flight Load Factors	2-6
2.19 Types of Operations.....	2-6
2.21 Fuel Limitations	2-6
2.25 Placards	2-7

THIS PAGE INTENTIONALLY LEFT BLANK

SECTION 2
LIMITATIONS

2.1 GENERAL

This section provides the "FAA Approved" operating limitations, instrument markings, color coding and basic placards necessary for operation of the airplane and its systems.

This airplane must be operated as a normal or utility category airplane in compliance with the operating limitations stated in the form of placards and markings and those given in this section and this complete handbook.

Limitations associated with those optional systems and equipment which require handbook supplements can be found in Section 9. (Supplements).

2.3 AIRSPEED LIMITATIONS

SPEED	KIAS	KCAS
Never Exceed Speed (VNE) - Do not exceed this speed in any operation.	154	148
Maximum Structural Cruising Speed (VNO) - Do not exceed this speed except in smooth air and then only with caution.	125	121

SECTION 2
LIMITATIONS

PA-28-181, ARCHER III

SPEED	KIAS	KCAS
Design Maneuvering Speed (VA) - Do not make full or abrupt control movements above this speed.		
At 2550 lbs. G.W.	113	111
At 1634 lbs. G.W.	89	89

CAUTION: Maneuvering speed decreases at lighter weight as the effects of aerodynamic forces become more pronounced. Linear interpolation may be used for intermediate gross weights. Maneuvering speed should not be exceeded while operating in rough air.

Maximum Flaps Extended Speed (VFE) - Do not exceed this speed with the flaps extended.	102	100
--	-----	-----

2.5 AIRSPEED INDICATOR MARKINGS

MARKING	IAS
Red Radial Line (Never Exceed)	154 KTS
Yellow Arc (Caution Range - Smooth Air Only)	125 KTS to 154 KTS
Green Arc (Normal Operating Range)	50 KTS to 125 KTS
White Arc (Flap Down)	45 KTS to 102 KTS

2.7 POWER PLANT LIMITATIONS

(a) Number of Engines	1
(b) Engine Manufacturer	Lycoming
(c) Engine Model No.	O-360-A4M
(d) Engine Operating Limits	
(1) Takeoff Power limit (BHP)	180
(2) Takeoff Engine Speed (RPM)	2700
(3) Maximum Oil Temperature	245F
(4) Oil Pressure	
Minimum (red line)	25 PSI
Maximum (red line)	115 PSI
(5) Fuel Pressure	
Minimum (red line)	0.5 PSI
Maximum (red line)	8 PSI
(6) Fuel (AVGAS ONLY) (minimum grade)	100 or 100LL Aviation Grade
(7) Number of Propellers	1
(8) Propeller Manufacturer	Sensenich
(9) Propeller Model	76EM8S14-0-62
(10) Propeller Diameter	
Minimum	76 IN.
Maximum	76 IN.
(11) Propeller Tolerance (static RPM at maximum permissible throttle setting at sea level) at ISA conditions	Not above 2340 RPM Not below 2240 RPM

NOTE: Reference aircraft maintenance manual for test procedure to determine approved static RPM under non-standard conditions.

2.9 POWER PLANT INSTRUMENT MARKINGS

- (a) Tachometer
 - Green Arc (Normal Operating Range) 500 to 2700 RPM
 - Red Line (Takeoff Power) 2700 RPM
- (b) Oil Temperature
 - Green Arc (Normal Operating Range) 100° to 245°F
 - Red Line (Maximum) 245°F
- (c) Oil Pressure
 - Green Arc (Normal Operating Range) 55 PSI to 95 PSI
 - Yellow Arc (Caution Range) (Idle) 25 PSI to 55 PSI
 - Yellow Arc (Ground Warm-Up) 95 PSI to 115 PSI
 - Red Line (Minimum) 25 PSI
 - Red Line (Maximum) 115 PSI
- (d) Fuel Pressure
 - Green Arc (Normal Operating Range) 0.5 PSI to 8 PSI
 - Red Line (Minimum) 0.5 PSI
 - Red Line (Maximum) 8 PSI
- (e) Vacuum Gauge
 - Red Line (Minimum) 4.8 in Hg
 - Green Arc (Normal Operating Range) 4.8 in Hg. to 5.2 in Hg
 - Red Line (Maximum) 5.2 in Hg

2.11 WEIGHT LIMITS

	Normal	Utility
(a) Maximum Ramp (lbs.)	2558	2138
(b) Maximum Weight (lbs.)	2550	2130
(c) Maximum Baggage (lbs.)	200	0

NOTE

Refer to Section 5 (Performance) for maximum weight as limited by performance.

2.13 CENTER OF GRAVITY LIMITS

(a) Normal Category

Weight Pounds	Forward Limit Inches Aft of Datum	Rearward Limit Inches Aft of Datum
2550	88.6	93.0
2050 (and less)	82.0	93.0

(b) Utility Category

Weight Pounds	Forward Limit Inches Aft of Datum	Rearward Limit Inches Aft of Datum
2130	83.0	93.0
2050 (and less)	82.0	93.0

NOTES

Straight line variation between points given.

The datum used is 78.4 inches ahead of the wing leading edge at the inboard intersection of the straight and tapered section.

It is the responsibility of the airplane owner and the pilot to insure that the airplane is properly loaded. See Section 6 (Weight and Balance) for proper loading instructions.

2.15 MANEUVER LIMITS

- (a) Normal Category - All acrobatic maneuvers including spins prohibited.
- (b) Utility Category - Approved maneuvers for bank angles exceeding 60°.

	Entry Speed
Steep Turns	113 KIAS
Lazy Eights	113 KIAS
Chandelles	113 KIAS

2.17 FLIGHT LOAD FACTORS

	Normal	Utility
(a) Positive Load Factor (Maximum)	3.8 G	4.4 G
(b) Negative Load Factor (Maximum)	No inverted maneuvers approved	

2.19 TYPES OF OPERATION

The airplane is approved for the following operations when equipped in accordance with FAR 91 or FAR 135.

- (a) Day V.F.R.
- (b) Night V.F.R.
- (c) Day I.F.R.
- (d) Night I.F.R.
- (e) Non Icing

2.21 FUEL LIMITATIONS

- (a) Total Capacity 50 U.S. GAL.
- (b) Unusable Fuel 2 U.S. GAL.
The unusable fuel for this airplane has been determined as 1.0 gallon in each wing in critical flight attitudes.
- (c) Usable Fuel 48 U.S. GAL.
The usable fuel in this airplane has been determined as 24.0 gallons in each wing.

2.25 PLACARDS

In full view of the pilot:

"THIS AIRPLANE MUST BE OPERATED AS A NORMAL OR UTILITY CATEGORY AIRPLANE IN COMPLIANCE WITH THE OPERATING LIMITATIONS STATED IN THE FORM OF PLACARDS, MARKINGS AND MANUALS.

ALL MARKINGS AND PLACARDS ON THIS AIRPLANE APPLY TO ITS OPERATION AS A UTILITY CATEGORY AIRPLANE. FOR NORMAL AND UTILITY CATEGORY OPERATION REFER TO THE PILOT'S OPERATING HANDBOOK.

NO ACROBATIC MANEUVERS ARE APPROVED FOR NORMAL CATEGORY OPERATIONS. SPINS ARE PROHIBITED FOR NORMAL AND UTILITY CATEGORY."

SECTION 2
LIMITATIONS

PA-28-181, ARCHER III

In full view of the pilot, in the area of the air conditioner control panel when the air conditioner is installed:

“WARNING” AIR CONDITIONER MUST BE OFF TO INSURE NORMAL TAKEOFF CLIMB PERFORMANCE.”

Adjacent to upper door latch:

“ENGAGE LATCH BEFORE FLIGHT.”

On inside of the baggage compartment door.

“BAGGAGE MAXIMUM 200 LBS.”

“UTILITY CATEGORY OPERATION - NO BAGGAGE OR AFT PASSENGERS ALLOWED. NORMAL CATEGORY OPERATION - SEE PILOT'S OPERATING HANDBOOK WEIGHT AND BALANCE SECTION FOR BAGGAGE AND AFT PASSENGER LIMITATIONS.”

In full view of the pilot:

“V_A 113 KIAS AT 2550# (SEE P.O.H.)”

“DEMO. X-WIND 17 KTS.”

NOTE

Demonstrated crosswind values are NOT limitations.

In full view of the pilot:

“UTILITY CATEGORY OPERATION ONLY.”

- (1) NO AFT PASSENGERS ALLOWED.
- (2) ACROBATIC MANEUVERS ARE LIMITED TO THE FOLLOWING:

	ENTRY SPEED
SPINS PROHIBITED	—
STEEP TURNS	113 KIAS
LAZY EIGHTS	113 KIAS
CHANDELLES	113 KIAS

In full view of the pilot:

“WARNING” TURN OFF STROBE LIGHTS WHEN IN CLOSE PROXIMITY TO GROUND OR DURING FLIGHT THROUGH CLOUD, FOG OR HAZE.”

Adjacent to the filler caps:



INTENTIONALLY LEFT BLANK



TABLE OF CONTENTS
SECTION 3
EMERGENCY PROCEDURES

Paragraph No.		Page No.
3.1	General	3-1
3.3	Airspeeds for Safe Operation	3-2
3.5	Emergency Procedures Checklist	3-2
	Engine Fire During Start	3-2
	Engine Power Loss During Takeoff	3-2
	Engine Power Loss In Flight	3-3
	Power Off Landing	3-3
	Fire In Flight.....	3-4
	Loss of Oil Pressure	3-4
	Loss of Fuel Pressure	3-4
	High Oil Temperature.....	3-5
	Electrical Failures.....	3-5
	Electrical Overload.....	3-6
	Spin Recovery	3-6
	Open Door	3-7
	Carburetor Icing	3-7
	Engine Roughness	3-7
3.7	Amplified Emergency Procedures (General)	3-9
3.9	Engine Fire During Start	3-9
3.11	Engine Power Loss During Takeoff	3-9
3.13	Engine Power Loss In Flight.....	3-10
3.15	Power Off Landing	3-11
3.17	Fire In Flight.....	3-11
3.19	Loss of Oil Pressure	3-12
3.21	Loss of Fuel Pressure	3-13
3.23	High Oil Temperature.....	3-13

TABLE OF CONTENTS (cont)

SECTION 3 (cont)

Paragraph No.		Page No.
3.25	Electrical Failures.....	3-14
3.27	Electrical Overload.....	3-14
3.29	Spin Recovery	3-15
3.31	Open Door	3-15
3.33	Carburetor Icing	3-16
3.35	Engine Roughness	3-16

SECTION 3

EMERGENCY PROCEDURES

3.1 GENERAL

The recommended procedures for coping with various types of emergencies and critical situations are provided by this section. All of required (FAA regulations) emergency procedures and those necessary for the operation of the airplane as determined by the operating and design features of the airplane are presented.

Emergency procedures associated with those optional systems and equipment which require handbook supplements are provided in Section 9 (Supplements).

The first portion of this section consists of an abbreviated emergency check list which supplies an action sequence for critical situations with little emphasis on the operation of systems.

The remainder of the section is devoted to amplified emergency procedures containing additional information to provide the pilot with a more complete understanding of the procedures.

These procedures are suggested as a course of action for coping with the particular condition described, but are not a substitute for sound judgment and common sense. Pilots should familiarize themselves with the procedures given in this section and be prepared to take appropriate action should an emergency arise.

Most basic emergency procedures, such as power off landings, are a normal part of pilot training. Although these emergencies are discussed here, this information is not intended to replace such training, but only to provide a source of reference and review, and to provide information on procedures which are not the same for all aircraft. It is suggested that the pilot review standard emergency procedures periodically to remain proficient in them.

SECTION 3

EMERGENCY PROCEDURES

PA-28-181, ARCHER III

3.3 AIRSPEEDS FOR SAFE OPERATION

Stall Speeds	
2550 lbs (0° Flaps).....	50 KIAS
2550 lbs (Full Flaps).....	45 KIAS
Maneuvering Speeds	
2550 lbs.....	113 KIAS
1634 lbs.....	89 KIAS
Never Exceed Speed.....	154 KIAS
Power Off Glide Speed	
2550 lbs (0° Flaps).....	76 KIAS

3.5 EMERGENCY PROCEDURES CHECK LIST

ENGINE FIRE DURING START

- Startercrank engine
- Mixtureidle cut-off
- Throttleopen
- Electric fuel pump.....OFF
- Fuel selector.....OFF
- Abandon if fire continues.

ENGINE POWER LOSS DURING TAKEOFF

If sufficient runway remains for a normal landing, land straight ahead.

If insufficient runway remains:

- Maintain safe airspeed.
- Make only shallow turn to avoid obstructions.
- Flaps as situation requires.

If sufficient altitude has been gained to attempt a restart:

Maintain safe airspeed.

- Fuel selector.....switch to tank containing fuel
- Electric fuel pump.....check ON
- Mixturecheck RICH
- Carburetor heat.....ON

If power is not regained, proceed with power off landing.

ENGINE POWER LOSS IN FLIGHT

If at low altitude:

AirspeedMAINTAIN 76 KIAS
Minimum

If altitude permits:

Fuel selector.....switch to tank
containing fuel
Electric fuel pumpON
MixtureRICH
Carburetor heatON
Engine gaugescheck for indication
of cause of power loss

If no fuel pressure is indicated, check tank selector position to be sure it is on a tank containing fuel.

When power is restored:

Carburetor heatOFF
Electric fuel pump.....OFF

If power is not restored prepare for power off landing.

POWER OFF LANDING

Trim for 76 KIAS.

Locate suitable field.

Establish spiral pattern.

1000 ft. above field at downwind position for normal landing approach.

When field can easily be reached, slow to 66 KIAS for shortest landing.

Touchdowns should normally be made at lowest possible airspeed with full flaps.

When committed to landing:

FlapsAs desired
Throttle.....Close
Mixtureidle cut-off
Magnetos.....OFF
Battery Master switch.....OFF
ALTR SwitchOFF
Fuel selector.....OFF
Seat belt and harness.....tight

FIRE IN FLIGHT

Source of firecheck

Electrical fire (smoke in cabin):

Batt. Master switchOFF

ALTR switchOFF

Ventsopen

Cabin heatOFF

Land as soon as possible.

Engine fire:

Fuel selectorOFF

ThrottleCLOSED

Mixtureidle cut-off

Electric fuel pumpcheck OFF

Heater and defrosterOFF

Proceed with power off landing procedure.

NOTE:

The possibility of an engine fire in flight is extremely remote. The procedure given is general and Pilot judgment should be the determining factor for action in such an emergency.

LOSS OF OIL PRESSURE

Land as soon as possible and investigate cause.

Prepare for power off landing.

LOSS OF FUEL PRESSURE

Electric fuel pumpON

Fuel selectorcheck on full tank

HIGH OIL TEMPERATURE

Land at nearest airport and investigate the problem.
Prepare for power off landing.

ELECTRICAL FAILURES

NOTE:

Anytime the bus voltage is below 25 Vdc, the Low
Bus Voltage Annunciator will be illuminated.

ALT annunciator light illuminated:

Ammeter.....Check to verify inop. alt.

If ammeter shows zero:

ALT switch.....OFF

Reduce electrical loads to minimum:

ALT circuit breaker.....Check and reset
as required

ALT switchON

If power not restored:

ALT switch.....OFF

If alternator output cannot be restored, reduce electrical loads and land as soon
as practical. Anticipate complete electrical failure. Duration of battery power
will be dependent on electrical load and battery condition prior to failure.

NOTE:

Low Bus Voltage Annunciator will be illuminated.

ELECTRICAL OVERLOAD (Alternator over 20 amps above known electrical load)

ALT switchON
BAT switchOFF

If alternator loads are reduced:

Electrical loadReduce to Minimum

Land as soon as practical.

NOTE

Due to increased system voltage and radio frequency noise, operation with ALT switch ON and BAT switch OFF should be made only when required by an electrical system failure.

If alternator loads are not reduced:

ALT switchOFF
BAT switchAs required

Land as soon as possible. Anticipate complete electrical failure.

SPIN RECOVERY

Rudderfull opposite to
direction of rotation

Control wheelfull forward while
neutralizing ailerons

Throttleidle

Rudderneutral (when rotation stops)

Control wheelas required to smoothly
regain level flight attitude

OPEN DOOR

If both upper and side latches are open, the door will trail slightly open and airspeeds will be reduced slightly.

To close the door in flight:
Slow airplane to 87 KIAS.

Cabin ventsclose
Storm windowopen

If upper latch is openlatch

If side latch is openpull on armrest while
moving latch handle
to latched position

If both latches are openlatch side latch
then top latch

CARBURETOR ICING

Carburetor heatON
Mixtureadjust for maximum
smoothness

ENGINE ROUGHNESS

Carburetor heatON

If roughness continues after one min:

Carburetor heatOFF

Mixtureadjust for maximum
smoothness

Electric fuel pumpON

Fuel selectorswitch tanks

Engine gaugescheck

Magneto switchesCheck Left then Right

If operation is satisfactory on either one, continue on that magneto at reduced power and full RICH mixture to first airport.

Prepare for power off landing.

THIS PAGE INTENTIONALLY LEFT BLANK

3.7 AMPLIFIED EMERGENCY PROCEDURES (GENERAL)

The following paragraphs are presented to supply additional information for the purpose of providing the pilot with a more complete understanding of the recommended course of action and probable cause of an emergency situation.

3.9 ENGINE FIRE DURING START

Engine fires during start are usually the result of overpriming. The first attempt to extinguish the fire is to try to start the engine and draw the excess fuel back into the induction system.

If a fire is present before the engine has started, move the mixture control to idle cut-off, open the throttle and crank the engine. This is an attempt to draw the fire back into the engine.

If the engine has started, continue operating to try to pull the fire into the engine.

In either case (above), if fire continues more than a few seconds, the fire should be extinguished by the best available external means.

The fuel selector valves should be OFF and the mixture at idle cut-off if an external fire extinguishing method is to be used.

3.11 ENGINE POWER LOSS DURING TAKEOFF

The proper action to be taken if loss of power occurs during takeoff will depend on the circumstances of the particular situation.

If sufficient runway remains to complete a normal landing, land straight ahead.

If insufficient runway remains, maintain a safe airspeed and make only a shallow turn if necessary to avoid obstructions. Use of flaps depends on the circumstances. Normally, flaps should be fully extended for touchdown.

SECTION 3

EMERGENCY PROCEDURES

PA-28-181, ARCHER III

If sufficient altitude has been gained to attempt a restart, maintain a safe airspeed and switch the fuel selector to another tank containing fuel. Check the electric fuel pump to insure that it is ON and that the mixture is RICH. The carburetor heat should be ON.

If engine failure was caused by fuel exhaustion, power will not be regained after switching fuel tanks until the empty fuel lines are filled. This may require up to ten seconds.

If power is not regained, proceed with the Power Off Landing procedure (refer to the emergency check list and Paragraph 3.15).

3.13 ENGINE POWER LOSS IN FLIGHT

Complete engine power loss is usually caused by fuel flow interruption and power will be restored shortly after fuel flow is restored. If power loss occurs at a low altitude, the first step is to prepare for an emergency landing (refer to Paragraph 3.15). An airspeed of at least 76 KIAS should be maintained.

If altitude permits, switch the fuel selector to another tank containing fuel and turn the electric fuel pump ON. Move the mixture control to RICH and the carburetor heat to ON. Check the engine gauges for an indication of the cause of the power loss. If no fuel pressure is indicated, check the tank selector position to be sure it is on a tank containing fuel.

When power is restored move the carburetor heat to the OFF position and turn OFF the electric fuel pump.

If the preceding steps do not restore power, prepare for an emergency landing.

If time permits, turn the Left and Right magneto switches OFF then ON one at a time. Move the throttle and mixture control levers to different settings. This may restore power if the problem is too rich or too lean a mixture or if there is a partial fuel system restriction. Try other fuel tanks. Water in the fuel could take some time to be used up, and allowing the engine to windmill may restore power. If power loss is due to water, fuel pressure indications will be normal.

If engine failure was caused by fuel exhaustion, power will not be restored after switching fuel tanks until the empty fuel lines are filled. This may require up to ten seconds.

If power is not regained, proceed with the Power Off Landing procedure (refer to the emergency check list and Paragraph 3.15).

3.15 POWER OFF LANDING

If loss of power occurs at altitude, trim the aircraft for best gliding angle 76 KIAS (Air Cond. off) and look for a suitable field. If measures taken to restore power are not effective, and if time permits, check your charts for airports in the immediate vicinity; it may be possible to land at one if you have sufficient altitude. If possible, notify the FAA by radio of your difficulty and intentions. If another pilot or passenger is aboard, let him help.

When you have located a suitable field, establish a spiral pattern around this field. Try to be at 1000 feet above the field at the downwind position, to make a normal landing approach. When the field can easily be reached, slow to 66 KIAS with flaps down for the shortest landing. Excess altitude may be lost by widening your pattern, using flaps or slipping, or a combination of these.

Touchdown should normally be made at the lowest possible airspeed.

When committed to a landing, lower the flaps as desired, close the throttle, move the mixture to idle cut-off, and shut OFF the magnetos. Turn the battery master and alternator switches OFF. Move the fuel selector valve to OFF. The seat belts and shoulder harness should be tightened.

3.17 FIRE IN FLIGHT

The presence of fire is noted through smoke, smell and heat in the cabin. It is essential that the source of the fire be promptly identified through instrument readings, character of the smoke, or other indications since the action to be taken differs somewhat in each case.

Check for the source of the fire first.

If an electrical fire is indicated (smoke in the cabin), the battery master switch should be turned OFF. The cabin vents should be opened and the cabin heat turned OFF. A landing should be made as soon as possible.

If an engine fire is present, switch the fuel selector to OFF and close the throttle. The mixture should be at idle cut-off. Turn the electric fuel pump OFF. In all cases, the heater and defroster should be OFF. If radio communication is not required, select battery master and alternator switches OFF. Proceed with power off landing procedure.

NOTE

The possibility of an engine fire in flight is extremely remote. The procedure given is general and pilot judgment should be the determining factor for action in such an emergency.

3.19 LOSS OF OIL PRESSURE

Loss of oil pressure may be either partial or complete. A partial loss of oil pressure usually indicates a malfunction in the oil pressure regulating system, and a landing should be made as soon as possible to investigate the cause and prevent engine damage.

A complete loss of oil pressure indication may signify oil exhaustion or may be the result of a faulty gauge. In either case, proceed toward the nearest airport, and be prepared for a forced landing. If the problem is not a pressure gauge malfunction, the engine may stop suddenly. Maintain altitude until such time as a dead stick landing can be accomplished. Don't change power settings unnecessarily, as this may hasten complete power loss.

Depending on the circumstances, it may be advisable to make an off airport landing while power is still available, particularly if other indications of actual oil pressure loss, such as sudden increases in temperatures, or oil smoke, are apparent, and an airport is not close.

If engine stoppage occurs, proceed with Power Off Landing.

3.21 LOSS OF FUEL PRESSURE

The most probable cause of loss of fuel pressure is either fuel depletion in the fuel tank selected or failure of the engine driven fuel pump. If loss of fuel pressure occurs, turn ON the electric fuel pump and check that the fuel selector is on a tank containing usable fuel.

If loss of fuel pressure is due to failure of the engine driven fuel pump the electric fuel pump will supply sufficient fuel pressure.

After fuel pressure and power are regained, turn the electric fuel pump OFF. If fuel pressure starts to drop, turn the electric fuel pump ON and land at the nearest suitable airport as soon as possible and have the cause investigated.

CAUTION

If normal engine operation and fuel pressure is not immediately re-established, the electric fuel pump should be turned off. The lack of fuel pressure indication could indicate a leak in the fuel system, or fuel exhaustion.

3.23 HIGH OIL TEMPERATURE

An abnormally high oil temperature indication may be caused by a low oil level, an obstruction in the oil cooler, damaged or improper baffle seals, a defective gauge, or other causes. Land as soon as practical at an appropriate airport and have the cause investigated.

A steady, rapid rise in oil temperature is a sign of trouble. Land at the nearest airport and let a mechanic investigate the problem. Watch the oil pressure gauge for an accompanying loss of pressure.

3.25 ELECTRICAL FAILURES**NOTE:**

Anytime the bus voltage is below 25 Vdc, the Low Bus Voltage Annunciator will be illuminated.

Loss of alternator output is detected through zero reading on the ammeter. Before executing the following procedure, insure that the reading is zero and not merely low by actuating an electrically powered device, such as the landing light. If no increase in the ammeter reading is noted, alternator failure can be assumed.

The electrical load should be reduced as much as possible. Check the alternator circuit breakers for a popped circuit.

The next step is to attempt to reset the overvoltage relay. This is accomplished by moving the ALT switch to OFF for one second and then to ON. If the trouble was caused by a momentary overvoltage condition (30.5 volts and up) this procedure should return the ammeter to a normal reading.

NOTE:

Low Bus Voltage Annunciator will be illuminated.

If the ammeter continues to indicate "0" output, or if the alternator will not remain reset, turn off the ALT switch, maintain minimum electrical load and land as soon as practical. Anticipate complete electrical failure. Duration of battery power will be dependent on electrical load and battery condition prior to failure.

3.27 ELECTRICAL OVERLOAD (Alternator over 20 amps above known electrical load)

If abnormally high alternator output is observed (more than 20 amps above known electrical load for the operating conditions) it may be caused by a low battery, a battery fault or other abnormal electrical load. If the cause is a low battery, the indication should begin to decrease toward normal within 5 minutes. If the overload condition persists attempt to reduce the load by turning off non-essential equipment.

Turn the BAT switch OFF and the ammeter should decrease. Turn the BAT switch ON and continue to monitor the ammeter. If the alternator output does not decrease within 5 minutes, turn the BAT switch OFF and land as soon as practical. All electrical loads are being supplied by the alternator.

NOTE

Due to higher voltage and radio frequency noise, operation with the ALT switch ON and the BAT switch OFF should be made only when required by an electrical failure.

3.29 SPIN RECOVERY

Intentional spins are prohibited in this airplane. If a spin is inadvertently entered, immediately apply full rudder opposite to the direction of rotation. Move the control wheel full forward while neutralizing the ailerons. Move the throttle to IDLE. When the rotation stops, neutralize the rudder and ease back on the control wheel as required to smoothly regain a level flight attitude.

3.31 OPEN DOOR

The cabin door is double latched, so the chances of its springing open in flight at both the top and side are remote. However, should you forget the upper latch, or not fully engage the side latch, the door may spring partially open. This will usually happen at takeoff or soon afterward. A partially open door will not affect normal flight characteristics, and a normal landing can be made with the door open.

If both upper and side latches are open, the door will trail slightly open, and airspeed will be reduced slightly.

To close the door in flight, slow the airplane to 87 KIAS, close the cabin vents and open the storm window. If the top latch is open, latch it. If the side latch is open, pull on the armrest while moving the latch handle to the latched position. If both latches are open, close the side latch then the top latch.

3.33 CARBURETOR ICING

Under certain moist atmospheric conditions at temperatures of -5°C to 20°C , it is possible for ice to form in the induction system, even in summer weather. This is due to the high air velocity through the carburetor venturi and the absorption of heat from this air by vaporization of the fuel.

To avoid this, carburetor preheat is provided to replace the heat lost by vaporization. Carburetor heat should be full on when carburetor ice is encountered. Adjust mixture for maximum smoothness.

3.35 ENGINE ROUGHNESS

Engine roughness is usually due to carburetor icing which is indicated by a drop in RPM, and may be accompanied by a slight loss of airspeed or altitude. If too much ice is allowed to accumulate, restoration of full power may not be possible; therefore, prompt action is required.

Turn carburetor heat on (See Note). RPM will decrease slightly and roughness will increase. Wait for a decrease in engine roughness or an increase in RPM, indicating ice removal. If no change in approximately one minute, return the carburetor heat to OFF.

If the engine is still rough, adjust the mixture for maximum smoothness. The engine will run rough if too rich or too lean. The electric fuel pump should be switched to ON and the fuel selector switched to the other tank to see if fuel contamination is the problem. Check the engine gauges for abnormal readings. If any gauge readings are abnormal, proceed accordingly. Select the Left magneto switch OFF then ON and repeat with the Right magneto switch. If operation is satisfactory on either magneto, proceed on that magneto at reduced power, with mixture full RICH, to a landing at the first available airport.

If roughness persists, prepare for a precautionary landing at pilot's discretion.

NOTE

Partial carburetor heat may be worse than no heat at all, since it may melt part of the ice, which will refreeze in the intake system. When using carburetor heat, therefore, always use full heat, and when ice is removed return the control to the full cold position.

TABLE OF CONTENTS
SECTION 4
NORMAL PROCEDURES

Paragraph No.		Page No.
4.1	General	4-1
4.3	Airspeeds for Safe Operations.....	4-1
4.5	Normal Procedures Checklist.....	4-3
	Preflight Check.....	4-3
	Engine Start - General.....	4-6
	Before Starting Engine.....	4-7
	Normal Start - Cold Engine.....	4-7
	Normal Start - Hot Engine	4-7
	Engine Start - When Flooded.....	4-8
	Starting With External Power Source.....	4-8
	Warm-Up.....	4-9
	Taxiing.....	4-9
	Ground Check	4-9
	Before Takeoff.....	4-10
	Takeoff.....	4-10
	Short Field, Obstacle Clearance	4-11
	Climb.....	4-11
	Cruising	4-11
	Descent	4-11
	Approach and Landing	4-12
	Stopping Engine	4-12
	Mooring	4-12
4.7	Preflight Check.....	4-14
4.9	Engine Start - General	4-17
4.11	Before Starting Engine	4-17
4.13	Starting Engine.....	4-18
4.15	Warm-Up	4-20
4.17	Taxiing.....	4-20
4.19	Ground Check	4-20

TABLE OF CONTENTS (cont)

SECTION 4 (cont)

Paragraph No.		Page No.
4.21	Before Takeoff.....	4-21
4.23	Takeoff.....	4-22
4.25	Climb.....	4-22
4.27	Cruising.....	4-23
4.29	Descent.....	4-24
4.31	Approach and Landing.....	4-24
4.33	Stopping Engine.....	4-25
4.35	Mooring.....	4-26
4.37	Stalls.....	4-26
4.39	Turbulent Air Operation.....	4-27
4.41	Weight and Balance.....	4-27
4.43	Noise Level.....	4-27

SECTION 4

NORMAL PROCEDURES

4.1 GENERAL

This section describes the recommended procedures for the conduct of normal operations for the Archer III. All of the required (FAA regulations) procedures and those necessary for operation of the airplane as determined by the operating and design features of the airplane are presented.

Normal procedures associated with those optional systems and equipment which require handbook supplements are provided by Section 9 (Supplements).

These procedures are provided to present a source of reference and review and to supply information on procedures which are not the same for all aircraft. Pilots should familiarize themselves with the procedures given in this section in order to become proficient in the normal operations of the airplane.

The first portion of this section consists of a short form check list which supplies an action sequence for normal operations with little emphasis on the operation of the systems.

The remainder of the section is devoted to amplified normal procedures which provide detailed information and explanations of the procedures and how to perform them. This portion of the section is not intended for use as an in-flight reference due to the lengthy explanations. The short form check list should be used for this purpose.

4.3 AIRSPEEDS FOR SAFE OPERATIONS

The following airspeeds are those which are significant to the safe operation of the airplane. These figures are for standard airplanes flown at gross weight under standard conditions at sea level.

SECTION 4**NORMAL PROCEDURES****PA-28-181, ARCHER III**

Performance for a specific airplane may vary from published figures depending upon the equipment installed, the condition of the engine, airplane and equipment, atmospheric conditions and piloting technique.

- | | |
|--|----------|
| (a) Best Rate of Climb Speed | 76 KIAS |
| (b) Best Angle of Climb Speed | 64 KIAS |
| (c) Turbulent Air Operating Speed (See Subsection 2.3) | 113 KIAS |
| (d) Maximum Flap Speed | 102 KIAS |
| (e) Landing Final Approach Speed (Flaps 40) | 66 KIAS |
| (f) Maximum Demonstrated Crosswind Velocity | 17 KTS |

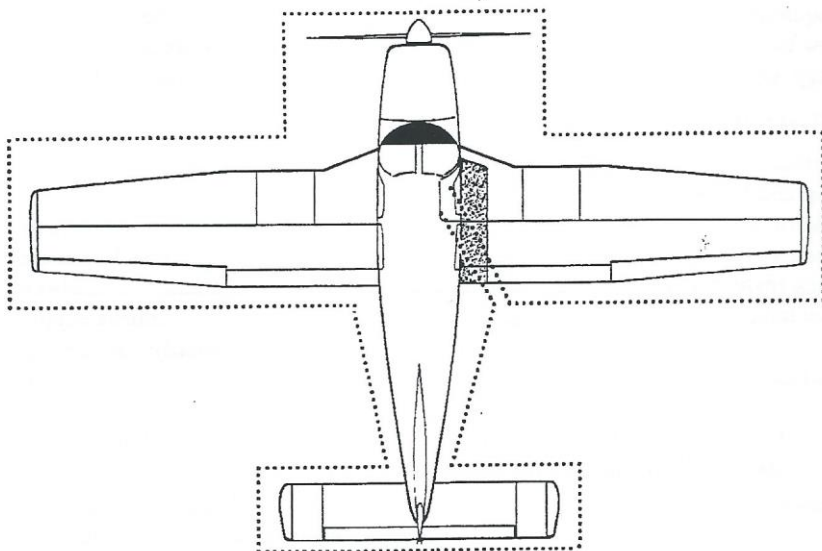

WALK-AROUND

Figure 4-1

4.5 NORMAL PROCEDURES CHECK LIST

PREFLIGHT CHECK

COCKPIT

- Control wheelrelease restraints
- Parking brakeset
- AvionicsOFF
- All switchesOFF
- Mixtureidle cut-off
- Magneto switchesOFF
- Battery master switchON
- Fuel gaugescheck quantity
- Annunciator panelcheck
- Battery master switchOFF
- Flapsextend
- Primary flight controlsproper operation
- Trimneutral
- Pitot and static systemsdrain
- Windowscheck clean

Required papers and POHcheck on board
Tow bar and baggage.....stow properly - secure
Baggage doorclose and secure

RIGHT WING

Surface condition.....clear of ice, frost, snow
Flap and hingescheck
Aileron and hingescheck
Static wickscheck - secure
Wing tip and lights.....check
Fuel tank.....check supply
visually - secure cap
Fuel tank ventclear

CAUTION: When draining any amount of fuel, care should be taken to ensure that no fire hazard exists before starting engine.

Fuel tank sumpsdrain and check for
water, sediment and proper fuel
Tie down and chockremove
Main gear strut.....proper
inflation (4.5 ± .25 in.)
Tirecheck
Brake block and disc.....check
Fresh air inlet.....clear

NOSE SECTION

General condition.....check
Cowling.....secure
Windshieldclean
Propeller and spinnercheck
Air inletsclear
Engine baffle sealscheck
Chockremove
Nose gear strutproper
inflation (3.25 ± .25 in.)
Nose wheel tirecheck
Oilcheck quantity
Dipstick.....properly seated
Oil filler cap.....secure

CAUTION: When draining any amount of fuel, care should be taken to ensure that no fire hazard exists before starting engine.

Fuel strainerdrain

LEFT WING

Surface conditionclear of ice, frost, snow
 Fresh air inlet.....clear

CAUTION: When draining any amount of fuel, care should be taken to ensure that no fire hazard exists before starting engine.

Fuel tank sumpdrain and check for
 water, sediment and proper fuel

Fuel tank ventclear

Main gear strut.....proper
 inflation (4.5 ± .25 in.)

Tirecheck

Brake block and disc.....check

Tie down and chockremove

Fuel tank.....check supply
 visually - secure cap

Pitot/static head.....remove cover - holes clear

Wing tip and lights.....check

Aileron and hingescheck

Flap and hingescheck

Static wicks.....check secure

FUSELAGE

Antennascheck

Empennageclear of ice, frost, snow

Stabilator and trim tabcheck

Tie down.....remove

MISCELLANEOUS

Battery master switchON
 Flapsretract
 Interior lightingON and check
 Pitot heat switchON
 Pitot heat OFF/INOP Annunciatorextinguished

CAUTION: Care should be taken when an operational check of the heated pitot head is being performed. The unit becomes very hot. Ground operation should be limited to three minutes to avoid damaging the heater elements.

NOTE: Secure and adjust all unused seat belts and shoulder harness to prevent control interference or passenger injury during flight in turbulent air.

Exterior lighting switchesON and check
 Pitotcheck - warm
 Stall warning horncheck
 All lighting switchesOFF
 Pitot heat switchOFF
 Pitot heat OFF/INOP Annunciatorilluminated
 Battery master switchOFF
 Passengersboard
 DoorClosed and secure
 Seatsadjusted and /locked in position
 Seat belts and harnessfasten/adjust
 check inertia reel

ENGINE START - GENERAL

CAUTION: Do not attempt flight if there is no indication of alternator output.

CAUTION: If a positive oil pressure is not indicated within 30 seconds following an engine start, stop the engine and determine the trouble. In cold weather it will take a few seconds longer to get a positive oil pressure indication.

BEFORE STARTING ENGINE

Brakesset
 Circuit breakerscheck in
 Alternate static sourceOFF
 Carburetor heatfull cold
 AvionicsOFF
 Fuel selectordesired tank

NORMAL START - COLD ENGINE

Throttle1/4 in. open
 Battery master switchON
 Alternator switchON
 Left magneto switchON
 Electric fuel pumpON
 Mixturefull RICH
 Propellerclear
 Starterengage
 Throttleadjust
 Right magneto switchON
 Oil pressurecheck

NOTE: If engine does not start within 10 seconds, prime and repeat starting procedure. Starter manufacturer recommends starter cranking periods be limited to 10 seconds with a 2 minute rest period between cranking periods. Maximum of 5 start periods allowed. If start is not achieved on fifth attempt allow starter to cool for 30 minutes before attempting additional starts.

NORMAL START - HOT ENGINE

Throttle1/2 in. open
 Battery master switchON
 Alternator switchON
 Left magneto switchON
 Electric fuel pumpON
 Mixturefull RICH
 Propellerclear
 Starterengage
 Throttleadjust
 Right magneto switchON
 Oil pressurecheck

ENGINE START WHEN FLOODED

Throttle	open full
Battery master switch.....	ON
Alternator switch.....	ON
Left magneto switch	ON
Electric fuel pump	OFF
Mixture.....	idle cut-off
Propeller.....	clear
Starter	engage
Mixture	advance
Throttle	retard
Right magneto switch	ON
Oil Pressure	check

STARTING WITH EXTERNAL POWER SOURCE

CAUTION: It is possible to use the ship's battery in parallel by turning only the battery master switch ON. This will give longer cranking capabilities, but will not increase the amperage. Care should be exercised if the ship's battery has been depleted. The external power supply can be reduced to the level of the ship's battery. This can be tested by turning only the battery master switch on momentarily while the starter is engaged. If cranking speed increases, the ship's battery is at a higher level than the external power supply. If the battery is at a lower level than the external power supply, continue starting with the battery master switch off.

Battery master switch	OFF
Alternator switch	OFF
Left magneto switch	ON
All electrical equipment.....	OFF
Terminals	connect
External power plug.....	insert in fuselage

Proceed with normal start

- Throttlelowest possible RPM
- Right magneto switch.....ON
- External power plugdisconnect from fuselage
- Battery master switchON
- Alternator switchON - check ammeter
- Oil pressurecheck

WARM-UP

- Throttle800 to 1200 RPM

TAXIING

- Taxi areaclear
- Parking brakereleased
- Throttleapply slowly
- Brakescheck
- Steeringcheck

GROUND CHECK

- Parking brakeset
- Throttle2000 RPM
- Magnetosmax. drop 175 RPM
max. diff. 50 RPM
- Vacuum4.8 to 5.2 in. Hg.
- Oil temperaturecheck
- Oil pressurecheck
- Air conditioner (if installed)check
- Ammetercheck
- Annunciator panel.....press-to-test
- Carburetor heat.....approx. 75 RPM drop

Engine is warm for takeoff when throttle can be opened without engine faltering.

- Electric fuel pump.....OFF
- Fuel pressurecheck
- Throttleretard

BEFORE TAKEOFF

Battery master switch.....verify ON
Alternator switch.....verify ON
Magnetos.....verify ON
Flight instrumentscheck
Fuel selector.....proper tank
Electric fuel pumpON
Engine gaugescheck
Carburetor heatOFF
Mixtureset
Seat backserect
Seatsadjusted and locked in position
Belts/harness.....fastened/check
Empty seatsseat belts securely fastened
Flaps.....set
Trimset
Controls.....free
Door.....latched
Air conditioner (if installed).....OFF

TAKEOFF

NORMAL TECHNIQUE

Flaps.....set
Trimset

Accelerate to 60 KIAS

Control wheel.....back pressure to smoothly rotate
to climb attitude

SHORT FIELD, OBSTACLE CLEARANCE

Flaps25 (second notch)
 Trimslightly aft of neutral
 Throttlefull power prior to
 brake release

Accelerate to 55 KIAS depending on aircraft weight.

Control wheel.....back pressure to rotate
 to climb attitude

After breaking ground, accelerate to 60 KIAS depending on aircraft weight.

Accelerate to best flaps up angle of climb speed - 64 KIAS.

Flapsretract slowly
 (obstacle cleared & safe altitude)

Accelerate to best flaps up rate of climb speed - 76 KIAS.

CLIMB

Best rate (flaps up).....76 KIAS
 Best angle. (flaps up)64 KIAS
 En route.....87 KIAS
 Electric fuel pumpOFF at desired altitude

CRUISING

Powerset per power table
 Mixtureadjust

DESCENT

NORMAL

Throttle2500 rpm
 Airspeed.....122 KIAS
 MixtureRICH
 Carburetor heatON if required

POWER OFF

Carburetor heatON if required
 Throttle.....closed
 Airspeed.....as required
 Mixtureas required
 Powerverify with throttle
 every 30 seconds

APPROACH AND LANDING

Fuel selector.....proper tank
Seat backs.....erect
Seats.....adjusted and locked in position
Belts/harness.....fasten/adjust
Electric fuel pump.....ON
Mixture.....set
Flaps.....set - 102 KIAS max
Air conditioner (if installed).....OFF
Initial approach speed.....75 KIAS
Final approach speed (flaps 40°).....66 KIAS

STOPPING ENGINE

CAUTION:

The flaps must be placed in the up position for the flap stop to support weight. Passengers should be cautioned accordingly.

Flaps.....retract
Electric fuel pump.....OFF
Air conditioner (if installed).....OFF
Avionics master switch.....OFF
Electrical switches.....OFF
Throttle.....closed
Mixture.....idle cut-off
Magneto switches.....OFF
Alternator switch.....OFF
Battery master switch.....OFF

MOORING

Parking brake.....set
Flaps.....full up
Control wheel.....secured with belts
Wheel chocks.....in place
Tie downs.....secure

INTENTIONALLY LEFT BLANK

4.7 PREFLIGHT CHECK

The airplane should be given a thorough preflight and walk-around check. The preflight should include a check of the airplane's operational status, computation of weight and C.G. limits, takeoff distance and in-flight performance. A weather briefing should be obtained for the intended flight path, and any other factors relating to a safe flight should be checked before takeoff.

CAUTION

The flap position should be noted before boarding the airplane. The flaps must be placed in the UP position before they will lock and support weight on the step.

COCKPIT

Upon entering the cockpit, release the seat belts securing the control wheel. Set the parking brake by first depressing and holding the toe brake pedals and then pull the parking brake lever while depressing the knob attached to the top of the handle. Insure that all electrical switches are OFF. Turn OFF all avionics equipment (to save power and prevent wear on the units). The mixture should be in idle cut-off and the magneto switches in the OFF position. Turn ON the battery master switch, check the fuel quantity gauges for adequate supply, check that the annunciator panel illuminates. Turn OFF the battery master switch. Check the primary flight controls for proper operation, extend the flaps and set the trim to neutral. Open the pitot and static drains to remove any moisture that has accumulated in the lines. Check the windows for cleanliness and that the required papers are on board. Properly stow and secure the tow bar and baggage. Close and secure the baggage door.

RIGHT WING

Begin the walk-around at the trailing edge of the right wing by checking that the wing surface and control surfaces are clear of ice, frost, snow or other extraneous substances. Check the flap, aileron and hinges for damage and operational interference. Static wicks should be firmly attached and in good condition. Check the wing tip and lights for damage.

Open the fuel cap and visually check the fuel supply. Replace cap securely. The fuel tank vent should be clear of obstructions.

Place a container under the quick drain. Drain the fuel tanks through the quick drain prior to the first flight and after refueling, making sure that enough fuel has been drained to verify the proper fuel and insure that all water and sediment is removed.

CAUTION

When draining any amount of fuel, care should be taken to insure that no fire hazard exists before starting engine.

Remove the tie down and chock.

Next, complete a check of the landing gear. Check the gear strut for proper inflation; there should be $4.5 \pm .25$ inches of strut exposure under a normal static load. Check the tire for cuts, wear, and proper inflation. Make a visual check of the brake block and disc.

Check that the fresh air inlet is clear of foreign matter.

NOSE SECTION

Check the general condition of the nose section; look for oil or fluid leakage and that the cowling is secure. Check the windshield and clean if necessary. The propeller and spinner should be checked for detrimental nicks, cracks, or other defects. The air inlets should be clear of obstructions. Check the engine baffle seals

Remove the chock and check the nose gear strut for proper inflation; there should be $3.25 \pm .25$ inches of strut exposure under a normal static load. Check the tire for cuts, wear, and proper inflation. Check the oil level; make sure that the dipstick has been properly seated and that the oil filler cap has been properly secured. Drain the fuel strainer valve located on the bottom left side of the engine compartment.

CAUTION

When draining any amount of fuel, care should be taken to ensure that no fire hazard exists before starting engine.

LEFT WING

The wing surface should be clear of ice, frost, snow, or other extraneous substances. Check that the fresh air inlet is clear of foreign matter and remove the tie downs and chocks. Check the gear strut for proper inflation: there should be $4.5 \pm .25$ inches of strut exposure under a normal static load. Check the tire and the brake block and disc.

Open the fuel cap and visually check the fuel supply. Replace cap securely. The fuel tank vent should be clear of obstructions. Place a container under the quick drain. Drain enough fuel to verify the proper fuel and to insure that all water and sediment has been removed.

CAUTION

When draining any amount of fuel, care should be taken to ensure that no fire hazard exists before starting engine.

Remove the cover from the pitot/static head on the underside of the wing. Make sure the holes are open and clear of obstructions. Check the wing tip and lights for damage. Check the aileron, flap, and hinges for damage and operational interference. Check that the static wicks are firmly attached and in good condition.

FUSELAGE

Check the condition of any antennas located on the fuselage. All surfaces of the empennage should be examined for damage and operational interference and clear of ice, frost and snow. Fairings and access covers should be attached properly. Check the baggage to be sure it is stowed properly. Check that the lights on the tail are clean and intact. The stabilator and rudder should be operational and free from interference of any type. Check the condition of the tabs and insure that all hinges and push rods are sound and operational. If the tail has been tied down, remove the tie down rope.

MISCELLANEOUS

Turn the battery master switch "ON" and begin checking the interior lights by turning "ON" the necessary switches. After the interior lights are checked, turn "ON" the pitot heat switch and the exterior light switches. Next, perform a walk-around check on the exterior lights. With the pitot heat on the pitot heat OFF/INOP annunciator will extinguish informing the pilot that the pitot heat is activated.

Check the heated pitot head for proper heating. Turn all electrical switches and battery master switch OFF. Verify that the pitot heat OFF/INOP annunciator illuminates when pitot heat is turned OFF.

CAUTION:

Care should be taken when an operational check of the heated pitot head is being performed. The unit becomes very hot. Ground operation should be limited to three minutes maximum to avoid damaging the heating elements.

When all passengers are on board, the pilot should check the cabin doors for proper closing and latching procedures. The door should be gently pulled shut, the door handle firmly latched and the overhead latch button turned to the "LOCK" position. Seat belts on empty seats should be snugly fastened. All passengers should fasten their seat belts and shoulder harnesses. Adjust and lock seats in position.

NOTE:

With the shoulder harness fastened and adjusted, a pull test of it's locking restraint feature should be performed.

4.9 ENGINE START - GENERAL

CAUTION:

Do not attempt flight if there is no indication of alternator output.

CAUTION:

If a positive oil pressure is not indicated within 30 seconds following an engine start, stop the engine and determine the trouble. In cold weather it will take a few seconds longer to get a positive oil pressure indication.

NOTE:

Starter manufacturer recommends starter cranking periods be limited to 10 seconds with a 2 minute rest period between cranking periods. Maximum of 5 start periods allowed. If start is not achieved on fifth attempt allow starter to cool for 30 minutes before attempting additional starts.

4.11 BEFORE STARTING ENGINE

Before starting the engine, the brakes should be set. Check to make sure all the circuit breakers are in and the carburetor heat is off. Check that the avionics master switch is OFF. Check the fuel selector control to verify the desired tank.

STARTING ENGINE

(a) Starting Engine When Cold

Open the throttle lever approximately 1/4 inch. Turn ON the battery master switch, alternator switch, left magneto switch and the electric fuel pump.

Move the mixture control to full RICH, verify the propeller area is clear and engage the starter. When the engine fires, release the starter switch, and move the throttle to the desired setting. Turn ON the right magneto switch. Check the oil pressure for a positive indication.

If the engine does not fire within five to ten seconds, disengage the starter, prime the engine and repeat the starting procedure.

(b) Normal Start; Hot Engine

Open the throttle approximately 1/2 inch. Turn ON the battery master switch, alternator switch, left magneto switch and the electric fuel pump. Move the mixture control lever to full RICH, verify the propeller area is clear and engage the starter. When the engine fires, release the starter switch and move the throttle to the desired setting. Turn ON the right magneto switch. Check the oil pressure for a positive indication.

(c) Engine Start When Flooded

The throttle lever should be full OPEN. Turn ON the battery master switch, alternator switch, left magneto switch, and turn OFF the electric fuel pump. Move the mixture control lever to idle cut-off, verify the propeller area is clear and engage the starter. When the engine fires, release the starter switch, advance the mixture and retard the throttle. Turn ON the right magneto switch. Check the oil pressure for a positive indication.

(d) Starting Engine With External Power Source

CAUTION:

It is possible to use the ship's battery in parallel by turning only the battery master switch ON. This will give longer cranking capabilities, but will not increase the amperage. Care should be exercised if the ship's battery has been depleted. The external power supply can be reduced to the level of the ship's battery. This can be tested by turning only the battery master switch on momentarily while the starter is engaged. If cranking speed increases, the ship's battery is at a higher level than the external power supply. If the battery is at a lower level than the external power supply, continue starting with the battery master switch off.

Verify that the battery master, alternator switches are OFF, left magneto switch is ON, and all electrical equipment is OFF. Connect the RED lead of the PEP kit jumper cable to the POSITIVE () terminal of an external 24-volt battery and the BLACK lead to the NEGATIVE (-) terminal. Insert the plug of the jumper cable into the socket located on the fuselage. Note that when the plug is inserted, the electrical system is ON. Proceed with the normal starting technique.

After the engine has started, reduce power to the lowest possible RPM to reduce sparking, and turn ON the right magneto switch. Disconnect the jumper cable from the aircraft. Turn the battery master and alternator switches ON and check the alternator ammeter for an indication of output. Check the oil pressure for a positive indication. **DO NOT ATTEMPT FLIGHT IF THERE IS NO INDICATION OF ALTERNATOR OUTPUT.**

4.15 WARM-UP

Warm-up the engine at 800 to 1200 RPM for not more than two minutes in warm weather and four minutes in cold. Avoid prolonged idling at low RPM, as this practice may result in fouled spark plugs.

Takeoff may be made as soon as the ground check is completed, provided that the throttle may be opened fully without backfiring or skipping, and without a reduction in engine oil pressure.

Do not operate the engine at high RPM when running up or taxiing over ground containing loose stones, gravel or any loose material that may cause damage to the propeller blades.

4.17 TAXIING

Before attempting to taxi the airplane, ground personnel should be instructed and approved by a qualified person authorized by the owner. Ascertain that the propeller back blast and taxi areas are clear.

Power should be applied slowly to start the taxi roll. Taxi a few feet forward and apply the brakes to determine their effectiveness. While taxiing, make slight turns to ascertain the effectiveness of the steering.

Observe wing clearances when taxiing near buildings or other stationary objects. If possible, station an observer outside the airplane.

Avoid holes and ruts when taxiing over uneven ground.

Do not operate the engine at high RPM when running up or taxiing over ground containing loose stones, gravel or any loose material that may cause damage to the propeller blades.

4.19 GROUND CHECK

Set the parking brake.

The magnetos should be checked at 2000 RPM. Drop off on either magneto should not exceed 175 RPM and the difference between the magnetos should not exceed 50 RPM. Operation on one magneto should not exceed 10 seconds.

Check the vacuum gauge; the indicator should read 4.8" to 5.2" Hg at 2000 RPM.

Check the annunciator panel lights with the press-to-test button. Also check the air conditioner.

Carburetor heat should also be checked prior to takeoff to be sure the control is operating properly and to clear any ice which may have formed during taxiing. Avoid prolonged ground operation with carburetor heat "ON" as the air is unfiltered. Engine RPM should decrease no more than 75 RPM when carburetor heat is on. If no or excessive RPM decrease is observed, investigate and have the cause corrected prior to flight.

The electric fuel pump should be turned OFF after starting or during warm-up to make sure that the engine driven pump is operating. Prior to takeoff the electric pump should be turned ON again to prevent loss of power during takeoff should the engine driven pump fail.

4.21 BEFORE TAKEOFF

All aspects of each particular takeoff should be considered prior to executing the takeoff procedure.

Verify that the battery master, alternator, magneto switches are ON and check and set all of the flight instruments as required. Check the fuel selector to make sure it is on the proper tank (fullest). Turn ON the electric fuel pump and check the engine gauges. The carburetor heat should be in the OFF position.

All seat backs should be erect with all seats adjusted and locked in position.

The mixture should be set. The seat belts and shoulder harness should be fastened and adjusted. Fasten the seat belts snugly around the empty seats.

NOTE

With the shoulder harness fastened and adjusted, a pull test of its locking restraint feature should be performed.

Exercise and set the flaps and trim tab. Insure proper flight control movement and response.

All doors should be properly secured and latched.

On air conditioned models, the air conditioner must be OFF to insure normal takeoff performance.

4.23 TAKEOFF

NORMAL TECHNIQUE (SEE CHART, SECTION 5)

When the available runway length is well in excess of that required and obstacle clearance is no factor, the normal takeoff technique may be used. The flaps should be set in the retracted position and the pitch trim set slightly aft of neutral. Align the airplane with the runway, apply full power, and accelerate to 60 KIAS depending on weight. Apply back pressure to the control wheel to lift off, then control pitch attitude as required to attain the desired climb speed.

SHORT FIELD TECHNIQUE (SEE CHART, SECTION 5)

For departure from short runways with adjacent obstructions, a short field takeoff technique with flaps set to 25° should be used in accordance with the short field takeoff ground roll -flaps 25° and short field performance - flaps 25° charts. Maximum power is established before brake release and the airplane is accelerated to 55 KIAS depending on aircraft weight for liftoff. After liftoff, control the airplane attitude to accelerate to 60 KIAS depending on aircraft weight, passing through the 50 foot obstacle height. Once clear of the obstacle accelerate to the best flaps up angle of climb speed of 64 KIAS while retracting the flaps. Transition to 76 KIAS, flaps up best rate of climb speed.

4.25 CLIMB

The best rate of climb at gross weight will be obtained at 76 KIAS. The best angle of climb may be obtained at 64 KIAS. At lighter than gross weight these speeds are reduced somewhat. For climbing en route, a speed of 87 KIAS is recommended. This will produce better forward speed and increased visibility over the nose during the climb.

When reaching the desired altitude, the electric fuel pump may be turned off.

4.27 CRUISING

The cruising speed of the ARCHER III is determined by many factors, including power setting, altitude, temperature, loading and equipment installed in the airplane.

The normal maximum cruising power is 75% of the rated horsepower of the engine. Airspeeds which may be obtained at various altitudes and power settings can be determined from the performance graphs provided by Section 5.

Use of the mixture control in cruising flight reduces fuel consumption significantly, especially at higher altitudes. The mixture should be leaned during cruising operation above 5000 ft. altitude and at pilot's discretion at lower altitudes when 75% power or less is being used. If any doubt exists as to the amount of power being used, the mixture should be in the full RICH position for all operations under 5000 feet.

To lean the mixture, disengage the lock and pull the mixture control back.

Best economy mixture is obtained by slowly leaning the mixture until engine operation becomes rough or until engine power rapidly diminishes. When either condition occurs, enrich the mixture sufficiently to obtain an evenly firing engine. Some engine power and airspeed must be sacrificed to gain a best economy mixture setting.

Best power mixture is obtained by gradually leaning the mixture until either the tachometer or the airspeed indicator reading peaks.

If the airplane is equipped with the optional exhaust gas temperature (EGT) gauge, a more accurate means of leaning is available to the pilot. Best economy mixture is obtained by moving the mixture control aft until peak EGT is reached. Best power mixture is obtained by leaning to peak EGT and then enriching until the EGT is 100F. rich of the peak value. Under some conditions of altitude and throttle position, the engine may exhibit roughness before peak EGT is reached. If this occurs, the EGT corresponding to the onset of engine roughness should be used as the peak reference value.

Always remember that the electric fuel pump should be turned ON before switching tanks, and should be left on for a short period thereafter. In order to keep the airplane in best lateral trim during cruising flight the fuel should be used alternately from each tank. It is recommended that one tank be used for one hour after takeoff, then the other tank be used for two hours; then return to the first tank, which will have approximately one and one half hours of fuel remaining if the tanks were full at takeoff. The second tank will contain approximately one half hour of fuel. Do not run tanks completely dry in flight. The electric fuel pump should be normally OFF so that any

function of the engine driven fuel pump is immediately apparent. If signs of fuel starvation should occur at any time during flight, fuel exhaustion should be suspected, at which time the fuel selector should be immediately positioned to the other tank and the electric fuel pump switched to the ON position.

4.29 DESCENT

NORMAL

To achieve the performance on Figure 5-31 the power on descent must be used. The throttle should be set for 2500 RPM, mixture full rich and maintain an airspeed of 122 KIAS. In case carburetor ice is encountered apply full carburetor heat.

POWER OFF

If a prolonged power off descent is to be made, apply full carburetor heat prior to power reduction if icing conditions are suspected. Throttle should be retarded and mixture control leaned as required. Power response should be verified approximately every 30 seconds by partially opening and then closing the throttle (clearing the engine). When leveling off enrich mixture, set power as required and select carburetor heat off unless carburetor icing conditions are suspected.

4.31 APPROACH AND LANDING

Check to insure the fuel selector is on the proper (fullest) tank and that the seat backs are erect, with the seats adjusted and locked in position. The seat belts and shoulder harness should be fastened and adjusted and the inertia reel checked.

NOTE

With the shoulder harness fastened and adjusted, a pull test of its locking restraint feature should be performed.

Turn ON the electric fuel pump and turn OFF the air conditioner. The mixture should be set in the full RICH position.

The airplane should be trimmed to an initial approach speed of about 75 KIAS with a final approach speed of 66 KIAS with flaps extended. The flaps can be lowered at speeds up to 102 KIAS, if desired.

The mixture control should be kept in full RICH position to insure maximum acceleration if it should be necessary to open the throttle again. Carburetor heat should not be applied unless there is an indication of carburetor icing, since the use of carburetor heat causes a reduction in power which may be critical in case of a go-around. Full throttle operation with carburetor heat on can cause detonation.

The amount of flap used during landings and the speed of the aircraft at contact with the runway should be varied according to the landing surface and conditions of wind and airplane loading. It is generally good practice to contact the ground at the minimum possible safe speed consistent with existing conditions.

Normally, the best technique for short and slow landings is to use full flap and enough power to maintain the desired airspeed and approach flight path. Mixture should be full RICH, fuel on the fullest tank, and electric fuel pump ON. Reduce the speed during the flareout and contact the ground close to the stalling speed. After ground contact hold the nose wheel off as long as possible. As the airplane slows down, gently lower the nose and apply the brakes. Braking is most effective when flaps are raised and back pressure is applied to the control wheel, putting most of the aircraft weight on the main wheels. In high wind conditions, particularly in strong crosswinds, it may be desirable to approach the ground at higher than normal speeds with partial or no flaps.

4.33 STOPPING ENGINE

At the pilot's discretion, the flaps should be raised and the electric fuel pump turned OFF.

NOTE

The flaps must be placed in the UP position for the flap step to support weight. Passengers should be cautioned accordingly.

SECTION 4

NORMAL PROCEDURES

PA-28-181, ARCHER III

The air conditioner (when installed) and radios should be turned OFF, and the engine stopped by disengaging the mixture control lock and pulling the mixture control back to idle cut-off. The throttle should be left full aft to avoid engine vibration while stopping. Then the magneto, alternator and battery master, switches must be turned OFF.

4.35 MOORING

If necessary, the airplane should be moved on the ground with the aid of the nose wheel tow bar provided with each airplane and secured behind the rear seats. The aileron and stabilator controls should be secured by looping the safety belt through the control wheel and pulling it snug. The flaps are locked when in the UP position and should be left retracted.

Tie downs can be secured to rings provided under each wing and to the tail skid. The rudder is held in position by its connections to the nose wheel steering and normally does not have to be secured.

4.37 STALLS

The stall characteristics of the ARCHER III are conventional. An approaching stall is indicated by a stall warning horn which is activated between five and ten knots above stall speed. Mild airframe buffeting and gentle pitching may also precede the stall.

The gross weight stalling speed of the ARCHER III with power off and full flaps is 45 KIAS. With the flaps up this speed is increased 5 KTS. Loss of altitude during stalls varies from 100 to 350 feet, depending on configuration and power.

NOTE

The stall warning system is inoperative with the master switch OFF.

During preflight, the stall warning system should be checked by turning the master switch ON, lifting the detector and checking to determine if the horn is actuated. The master switch should be returned to the OFF position after the check is complete.

4.39 TURBULENT AIR OPERATION

In keeping with good operating practice used in all aircraft, it is recommended that when turbulent air is encountered or expected, the airspeed be reduced to maneuvering speed to reduce the structural loads caused by gusts and to allow for inadvertent speed build-ups which may occur as a result of the turbulence or of distractions caused by the conditions. (See Subsection 2.3)

4.41 WEIGHT AND BALANCE

It is the responsibility of the owner and pilot to determine that the airplane remains within the allowable weight vs. center of gravity envelope while in flight.

For weight and balance data, refer to Section 6 (Weight and Balance).

4.43 NOISE LEVEL

(a) FAR 36 Appendix G for aircraft with the standard exhaust system, the noise level is 73.1 dB(A). For aircraft with the optional exhaust system, the noise level is 71.9 dB(A).

No determination has been made by the Federal Aviation Administration that the noise levels of this airplane are or should be acceptable or unacceptable for operation at, into, or out of, any airport.

The above statement notwithstanding, the noise level stated above has been verified by and approved by the Federal Aviation Administration in noise level test flights conducted in accordance with FAR 36, Noise Standards - Aircraft Type and Airworthiness Certification. This aircraft model is in compliance with all FAR 36 noise standards applicable to this type.

(b) ICAO 10 for aircraft with the standard exhaust system, the noise level is 77.7 dB(A). For aircraft with the optional exhaust system, the noise level is 75.3 dB(A).

INTENTIONALLY LEFT BLANK

TABLE OF CONTENTS
SECTION 5
PERFORMANCE

Paragraph No.		Page No.
5.1	General	5-1
5.3	Introduction to Performance and Flight Planning	5-1
5.5	Flight Planning Example	5-3
5.7	Performance Graphs	5-9
	List of Figures	5-9

THIS PAGE INTENTIONALLY LEFT BLANK

**SECTION 5
PERFORMANCE**

5.1 GENERAL

All of the required (FAA regulations) and complementary performance information applicable to the ARCHER III is provided by this section.

Performance information associated with those optional systems and equipment which require handbook supplements is provided by Section 9 (Supplements).

5.3 INTRODUCTION TO PERFORMANCE AND FLIGHT PLANNING

The performance information presented in this section is based on measured Flight Test Data corrected to I.C.A.O. standard day conditions and analytically expanded for the various parameters of weight, altitude, temperature, etc.

The performance charts are unfactored and do not make any allowance for varying degrees of pilot proficiency or mechanical deterioration of the aircraft. This performance, however, can be duplicated by following the stated procedures in a properly maintained airplane.

Effects of conditions not considered on the charts must be evaluated by the pilot, such as the effect of soft or grass runway surface on takeoff and landing performance, or the effect of winds aloft on cruise and range performance. Endurance can be grossly affected by improper leaning procedures, and inflight fuel flow and quantity checks are recommended.

REMEMBER! To get chart performance, follow the chart procedures.

SECTION 5
PERFORMANCE

PA-28-181, ARCHER III

The information provided by paragraph 5.5 (Flight Planning Example) outlines a detailed flight plan using the performance charts in this section. Each chart includes its own example to show how it is used.

WARNING

Performance information derived by extrapolation beyond the limits shown on the charts should not be used for flight planning purposes.

5.5 FLIGHT PLANNING EXAMPLE**(a) Aircraft Loading**

The first step in planning the flight is to calculate the airplane weight and center of gravity by utilizing the information provided by Section 6 (Weight and Balance) of this handbook.

The basic empty weight for the airplane as licensed at the factory has been entered in Figure 6-5. If any alterations to the airplane have been made effecting weight and balance, reference to the aircraft logbook and Weight and Balance Record (Figure 6-7) should be made to determine the current basic empty weight of the airplane.

Make use of the Weight and Balance Loading Form (Figure 6-11) and the C.G. Range and Weight graph (Figure 6-15) to determine the total weight of the airplane and the center of gravity position.

After proper utilization of the information provided, the following weights have been determined for consideration in the flight planning example.

The landing weight cannot be determined until the weight of the fuel to be used has been established [refer to item (g)(1)].

(1) Empty Weight	1400 lbs.
(2) Occupants (2 x 170 lbs.)	340 lbs.
(3) Baggage and Cargo	360 lbs.
(4) Fuel (6 lb./gal. x 50)	300 lbs.
(5) Takeoff Weight	2400 lbs.
(6) Landing Weight	
(a)(5) minus (g)(1), (2400 lbs.	
minus 160.2 lbs.)	2239.8 lbs.

The takeoff weight is below the maximum of 2550 lbs. and the weight and balance calculations have determined that the C.G. position is within the approved limits.

(b) Takeoff and Landing

After determining the aircraft loading, all aspects of takeoff and landing must be considered.

Conditions of the departure and destination airport must be acquired, evaluated and maintained throughout the flight.

Apply the departure airport conditions and takeoff weight to the appropriate Takeoff Performance graph (Figure 5-7 or 5-9) to determine the barrier distance or (Figure 5-11 or 5-13) to determine the length of runway necessary for the takeoff.

The landing distance calculations are performed in the same manner using the existing conditions at the destination airport and, when established, the landing weight.

The conditions and calculations for the example flight are listed below. The takeoff and landing distances required for the example flight have fallen well below the available runway lengths.

	Departure Airport	Destination Airport
(1) Pressure Altitude	2000 ft.	2500 ft.
(2) Temperature	23°C	21°C
(3) Wind Component (Headwind)	8 Kt.	5 Kt.
(4) Runway Length Available	7000 ft.	4500 ft.
(5) Runway Required	1073 ft.*	820 ft.**

NOTE

The remainder of the performance charts used in this flight plan example assume a no wind condition. The effect of winds aloft must be considered by the pilot when computing climb, cruise and descent performance.

*reference Figure 5-11 or 5-13

**reference Figure 5-37

(c) Climb

The next step in the flight plan is to determine the necessary climb segment components.

The desired cruise pressure altitude and corresponding cruise outside air temperature values are the first variables to be considered in determining the climb components from the Time, Distance and Fuel to Climb graph (Figure 5-17). After the time, distance and fuel for the cruise pressure altitude and outside air temperature values have been established, apply the existing conditions at the departure field to the graph (Figure 5-17). Now, subtract the values obtained from the graph for the field of departure conditions from those for the cruise pressure altitude.

The remaining values are the true fuel, distance and time components for the climb segment of the flight plan corrected for field pressure altitude and temperature.

The following values were determined from the above instructions in the flight planning example.

(1) Cruise Pressure Altitude	6000 ft.
(2) Cruise OAT	15°C
(3) Time to Climb (12 min. minus 3 min.)	9 min.*
(4) Distance to Climb (17 naut. miles minus 5 naut. miles)	12 naut. miles*
(5) Fuel to Climb (4 gal. minus 2 gal.)	2 gal.*

(d) Descent

The descent data will be determined prior to the cruise data to provide the descent distance for establishing the total cruise distance.

Utilizing the cruise pressure altitude and OAT, determine the basic time, distance and fuel for descent (Figure 5-31). These figures must be adjusted for the field pressure altitude and temperature at the destination airport. To find the necessary adjustment values, use the existing pressure altitude and temperature conditions at the destination airport as variables to find the time, distance and fuel values from

*reference Figure 5-17

the graph (Figure 5-31). Now, subtract the values obtained from the field conditions from the values obtained from the cruise conditions to find the true time, distance and fuel values needed for the flight plan.

The values obtained by proper utilization of the graphs for the descent segment of the example are shown below.

- (1) Time to Descend
(16 min. minus 6 min.) 10 min.*
- (2) Distance to Descend
(33 naut. miles minus 13 naut. miles) 20 naut. miles*
- (3) Fuel to Descend
(3.2 gal. minus 1.3 gal.) 1.9 gal. *

(e) Cruise

Using the total distance to be traveled during the flight, subtract the previously calculated distance to climb and distance to descend to establish the total cruise distance. Refer to the appropriate Avco Lycoming Operator's Manual when selecting the cruise power setting. The established pressure altitude and temperature values and the selected cruise power should now be utilized to determine the true airspeed from the appropriate Speed Power graph (Figure 5-20 [a,b] and 5-21).

Calculate the cruise fuel flow for the cruise power setting from the information provided by the Avco Lycoming Operator's Manual.

The cruise time is found by dividing the cruise distance by the cruise speed and the cruise fuel is found by multiplying the cruise fuel flow by the cruise time.

The cruise calculations established for the cruise segment of the flight planning example are as follows:

- (1) Total Distance 314 naut. miles
- (2) Cruise Distance
(e)(1) minus (c)(4) minus (d)(2),
(314 nm minus 12 nm minus 20 nm) 282 naut. miles

*reference Figure 5-31

(3) Cruise Power	65%
(4) Cruise Speed	117 Kts.*
(5) Cruise Fuel Consumption	9.5 gal./hr.
(6) Cruise Time	
(e)(2) divided by (e)(4), (282 nm divided by 117 kts)	2.4 hrs.
(7) Cruise Fuel	
(e)(5) multiplied by (e)(6), (9.5 gal./hr multiplied by 2.4 hrs)	22.8 gal..

(f) Total Flight Time

The total flight time is determined by adding the time to climb, the time to descend and the cruise time. Remember! The time values taken from the climb and descent graphs are in minutes and must be converted to hours before adding them to the cruise time.

The following flight time is required for the flight planning example.

(1) Total Flight Time	
(c)(3) plus (d)(1) plus (e)(6), (.15 hr plus .17 hr plus 2.4 hrs)	2.7 hrs

(g) Total Fuel Required

Determine the total fuel required by adding the fuel to climb, the fuel to descend and the cruise fuel. When the total fuel (in gallons) is determined, multiply this value by 6 lb./gal. to determine the total fuel weight used for the flight.

The total fuel calculations for the example flight plan are shown below.

(1) Total Fuel Required	
(c)(5) plus (d)(3) plus (e)(7), (2 gal. plus 1.9 gal. plus 22.8 gal.)	26.7 gal.
(26.7 gal. multiplied by 6 lb./gal.)	160.2 lbs

*reference Figure 5-20a

THIS PAGE INTENTIONALLY LEFT BLANK

5.7 PERFORMANCE GRAPHS

LIST OF FIGURES

Figure No.		Page No.
5-1	Temperature Conversion	5-11
5-3	Airspeed System Calibration.....	5-12
5-5	Stall Speeds	5-13
5-7	Flaps Up Takeoff Performance.....	5-14
5-9	25 Flaps Takeoff Performance	5-15
5-11	Flaps Up Takeoff Ground Roll	5-16
5-13	25 Flaps Takeoff Ground Roll.....	5-17
5-15	Climb Performance	5-18
5-17	Time, Distance and Fuel to Climb.....	5-19
5-19	Engine Performance	5-20
5-20	Engine/Cruise Performance (55%).....	5-21
5-20a	Engine/Cruise Performance (65%).....	5-22
5-20b	Engine/Cruise Performance (75%).....	5-23
5-21	Speed Power	5-25
5-27	Range (No reserve).....	5-26
5-27a	Range (45 min. reserve)	5-27
5-29	Endurance (No reserve)	5-28
5-29a	Endurance (45 min. reserve)	5-29
5-31	Time, Distance and Fuel to Descend.....	5-30
5-33	Glide Range.....	5-31
5-35	Landing Performance	5-32
5-37	Landing Ground Roll	5-33

THIS PAGE INTENTIONALLY LEFT BLANK

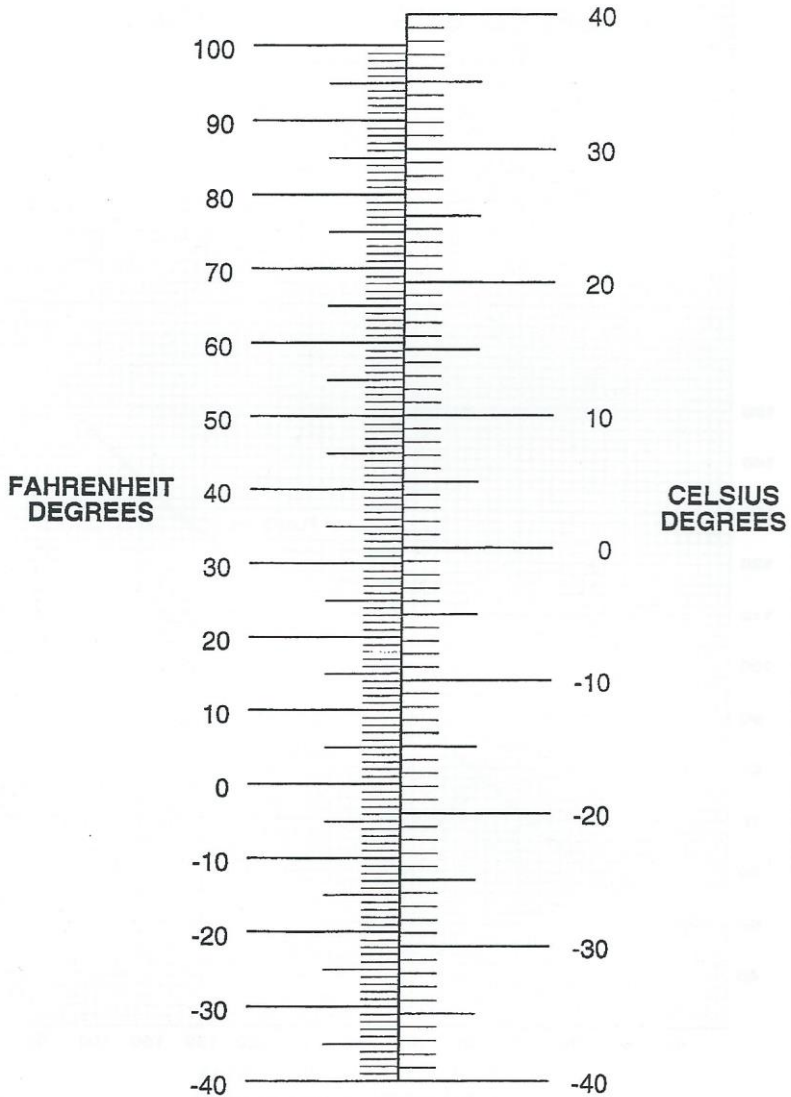

TEMPERATURE CONVERSION

Figure 5-1

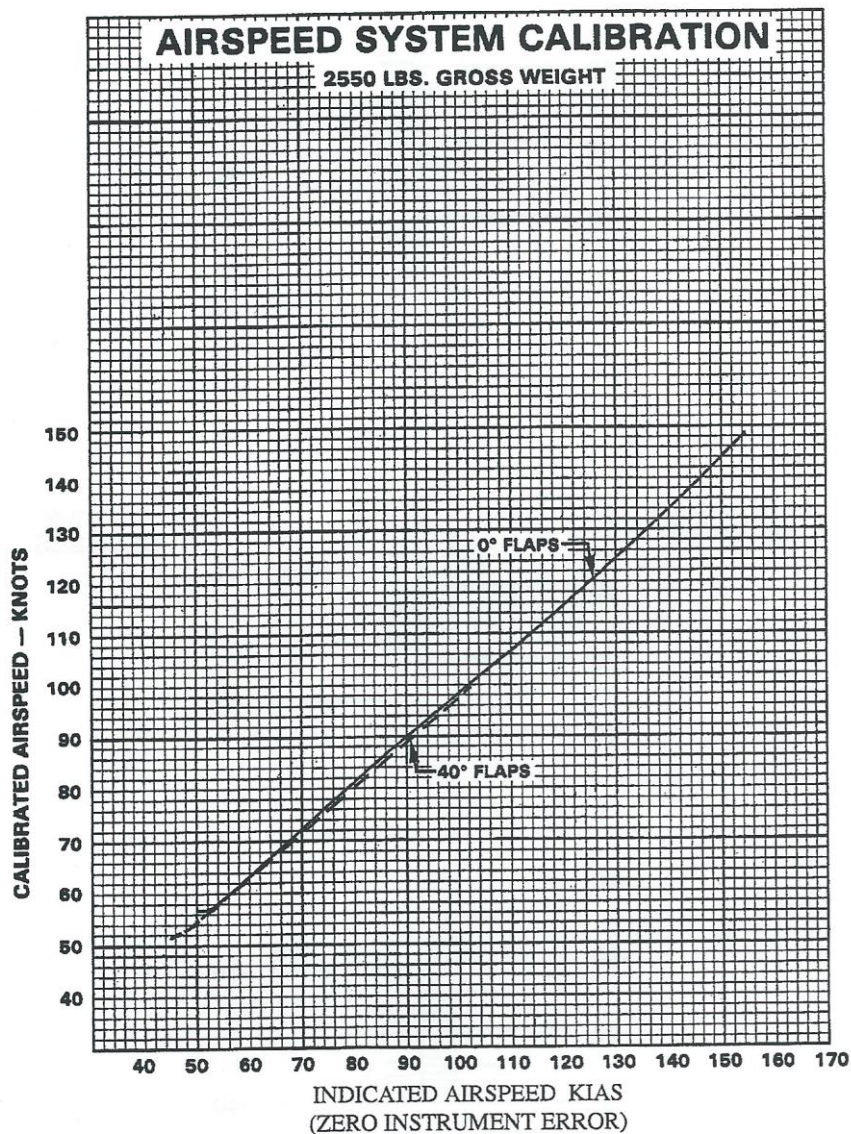

AIRSPEED SYSTEM CALIBRATION

Figure 5-3

POWER OFF STALL SPEED

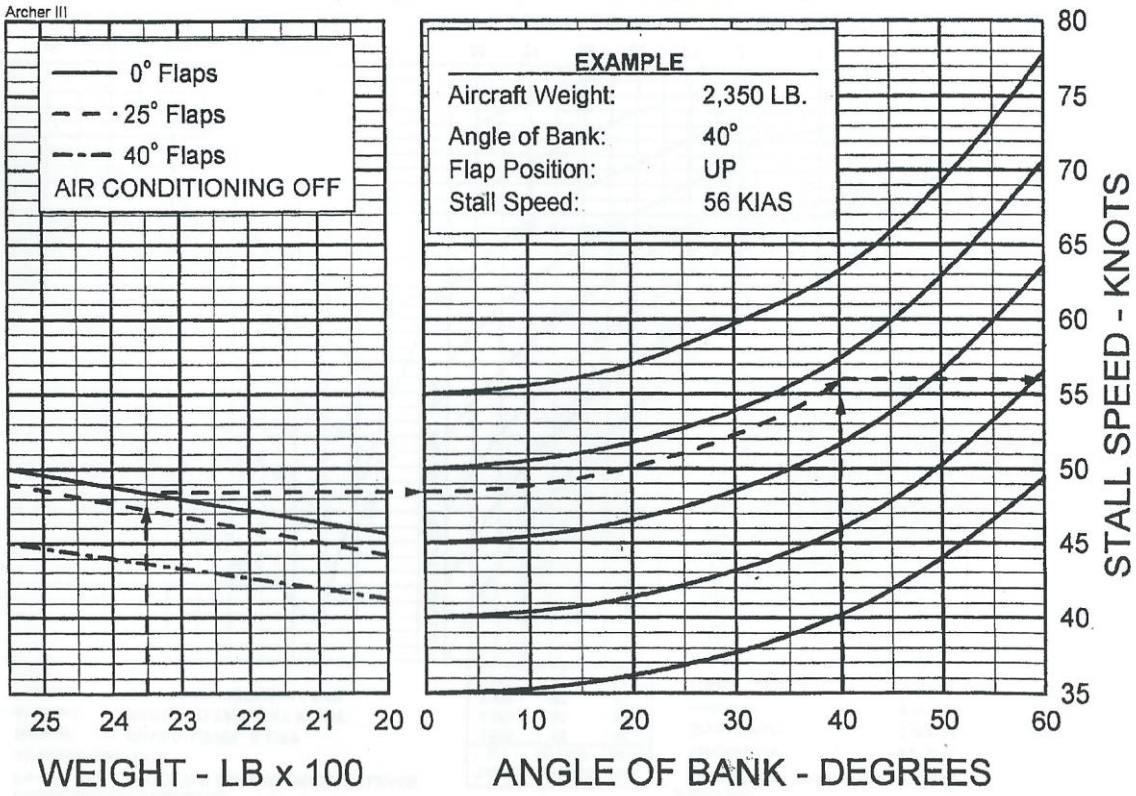

STALL SPEEDS
Figure 5-5

FLAPS UP TAKEOFF PERFORMANCE

ASSOCIATED CONDITIONS:

Power: FULL THROTTLE BEFORE BRAKE RELEASE
 Air Conditioner: OFF
 Runway: PAVED, LEVEL, & DRY
 Airspeed: REFER TO TABLE AT RIGHT
 Propeller: SENSENICH 76EM8S14-0-62
 Flaps: UP

EXAMPLE:

Depart Airport Pressure Alt: 2,000 Ft.
 Temperature: 23° C
 Gross Weight: 2,400 Lb.
 Headwind: 8 Kt.
 Takeoff Distance: 1907 Ft.

WT	KIAS	
	LIFTOFF	50 FT
2,550	60	65
2,450	58	64
2,350	57	63
2,250	56	61

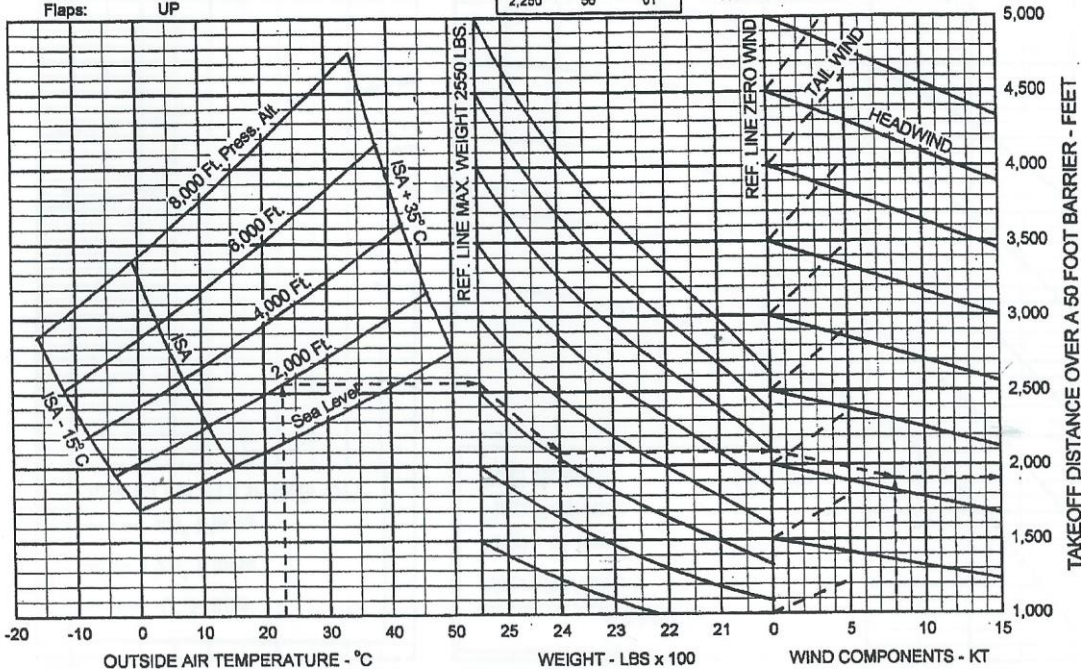

FLAPS UP TAKEOFF PERFORMANCE
 Figure 5-7

FLAPS 25° TAKEOFF PERFORMANCE

ASSOCIATED CONDITIONS

Power: FULL THROTTLE BEFORE BRAKE RELEASE
 Air Conditioner: OFF
 Runway: PAVED, LEVEL, & DRY
 Airspeed: REFER TO TABLE AT RIGHT
 Propeller: SENSENICH 76EMBS14-0-62
 Flaps: 25°

TAKEOFF SPEEDS		KIAS
WT	LIFTOFF	50 FT
2,550	55	60
2,450	55	58
2,350	53	56
2,250	50	54

EXAMPLE

Depart Airport Pressure Alt: 2,000 Ft.
 Temperature: 23° C
 Gross Weight: 2,400 Lb.
 Headwind: 8 Kt.
 Takeoff Distance: 1674 Ft.

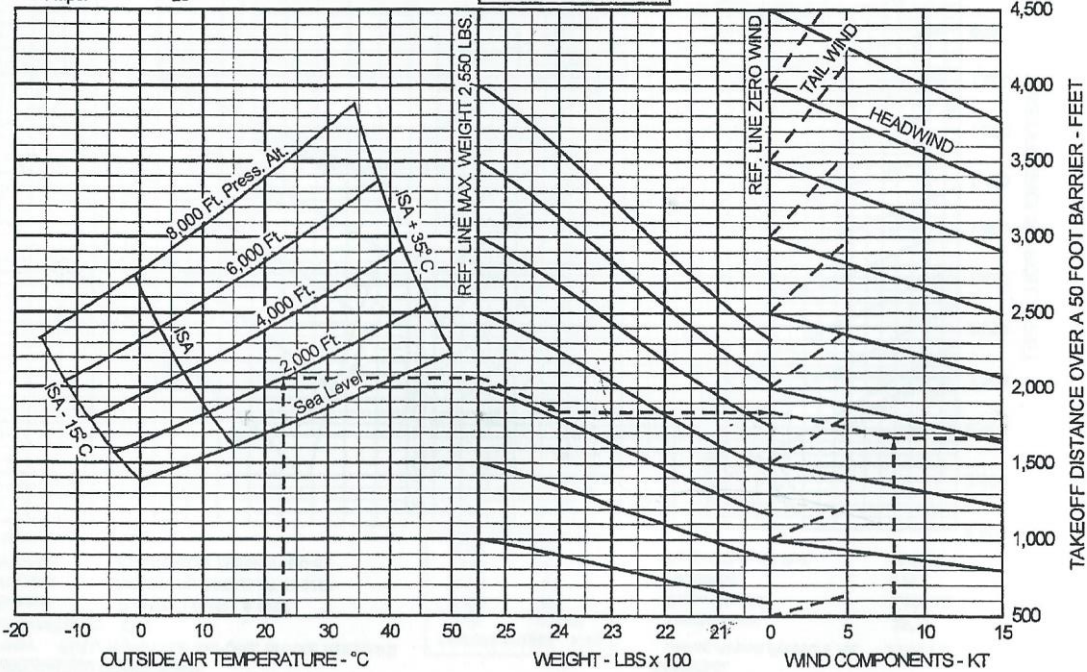

25° FLAPS TAKEOFF PERFORMANCE

Figure 5-9

FLAPS UP TAKEOFF GROUND ROLL

ASSOCIATED CONDITIONS:

Power: FULL THROTTLE BEFORE BRAKE RELEASE
 Air Conditioner: OFF
 Runway: PAVED, LEVEL, & DRY
 Airspeed: REFER TO TABLE AT RIGHT
 Propeller: SENSENICH 78EM8S14-0-82
 Flaps: UP

TAKEOFF SPEEDS KIAS	
WT	LIFTOFF
2,550	60
2,450	58
2,350	57
2,250	56

EXAMPLE:

Depart Airport Pressure Alt: 2,000 Ft.
 Temperature: 23° C
 Gross Weight: 2,400 Lb.
 Headwind: 8 Kt.
 Takeoff Ground Roll: 1073 Ft.

FLAPS UP TAKEOFF GROUND ROLL
 Figure 5-11

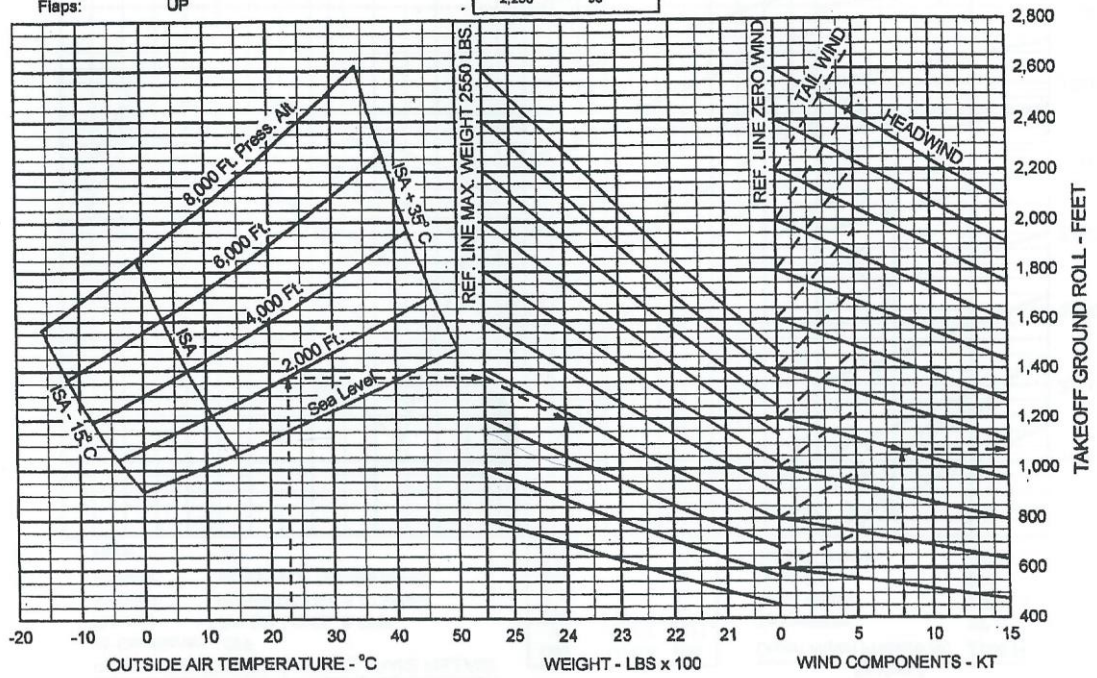

FLAPS 25° TAKEOFF GROUND ROLL

ASSOCIATED CONDITIONS

Power: FULL THROTTLE BEFORE BRAKE RELEASE
 Air Conditioner: OFF
 Runway: PAVED, LEVEL, & DRY
 Airspeed: REFER TO TABLE AT RIGHT
 Propeller: SENSENCH 76EMBS14-0-62
 Flaps: 25°

TAKEOFF SPEEDS KIAS	
WT	LIFTOFF
2,550	55
2,450	55
2,350	53
2,250	50

EXAMPLE

Depart Airport Pressure Alt: 2,000 Ft.
 Temperature: 23° C
 Gross Weight: 2,400 Lb.
 Headwind: 8 Kt.
 Takeoff Ground Roll: 1,071 Ft.

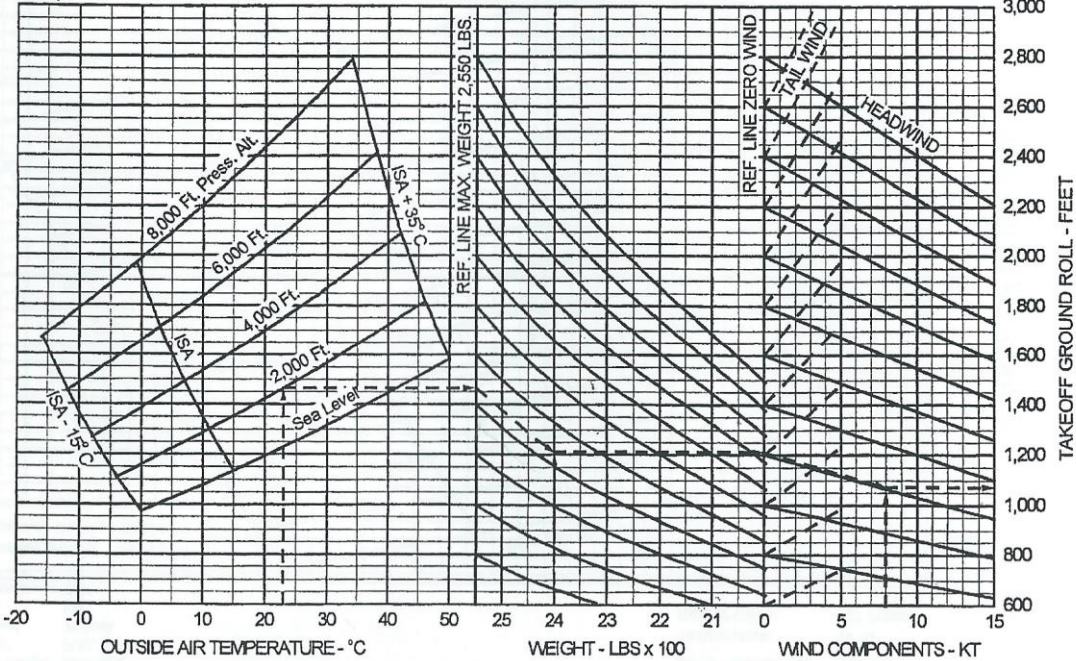

25° FLAPS TAKEOFF GROUND ROLL

Figure 5-13

EXAMPLE:

Climb Pressure Alt. 4000 Ft.
Temperature: 19° C
Rate of Climb: 487 FV/Min.

CLIMB PERFORMANCE

ASSOCIATED CONDITIONS:

Gross Weight: 2550 LBS.
Power: FULL THROTTLE
Airspeed: 78 KIAS
Flaps: UP
Air Conditioner: OFF

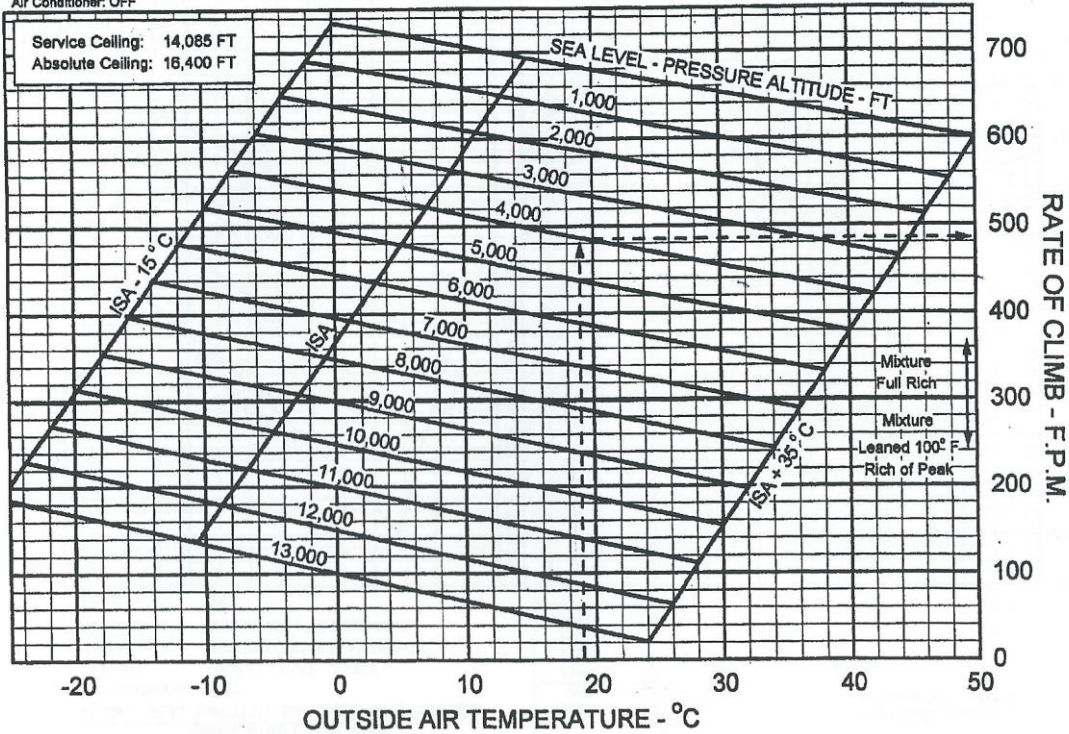

CLIMB PERFORMANCE
Figure 5-15

TIME, FUEL, DISTANCE TO CLIMB

ASSOCIATED CONDITIONS

Gross Weight: 2550 LB Flaps: UP
 Power: FULL THROTTLE Airspeed: 76 KIAS

EXAMPLE

Depart Airport Press Alt.: 2000 FT. Temperature: 23 °C
 Cruise Press Alt.: 6000 FT. Cruise OAT: 15 °C
 Time to Climb: 12 min. minus 3 min. = 9 min
 Fuel to Climb: 4 gal. minus 2 gal = 2 gal
 Distance to Climb: 17 n.m. minus 5 n.m. = 12 n.m.

NOTE: This chart includes fuel allowance for start, taxi, & takeoff.

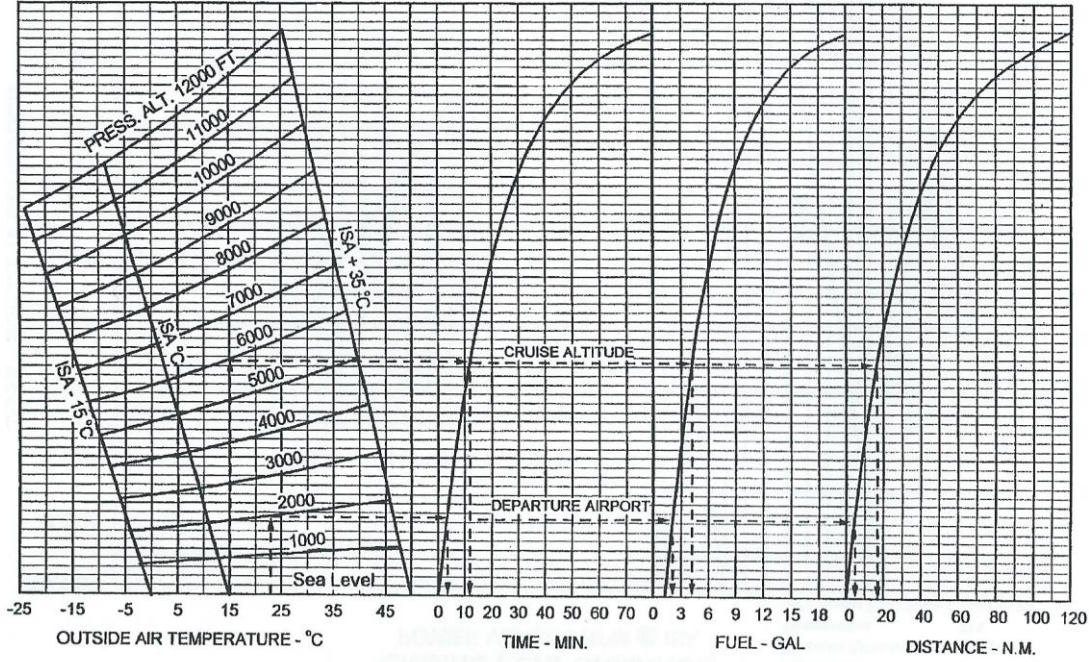

TIME, DISTANCE AND FUEL TO CLIMB

Figure 5-17

ENGINE PERFORMANCE POWER VERSUS RPM @ ISA

EXAMPLE:
Pressure Altitude: 7,375 Ft.
Temperature: ISA
65% Power Eng. Speed: 2487 RPM

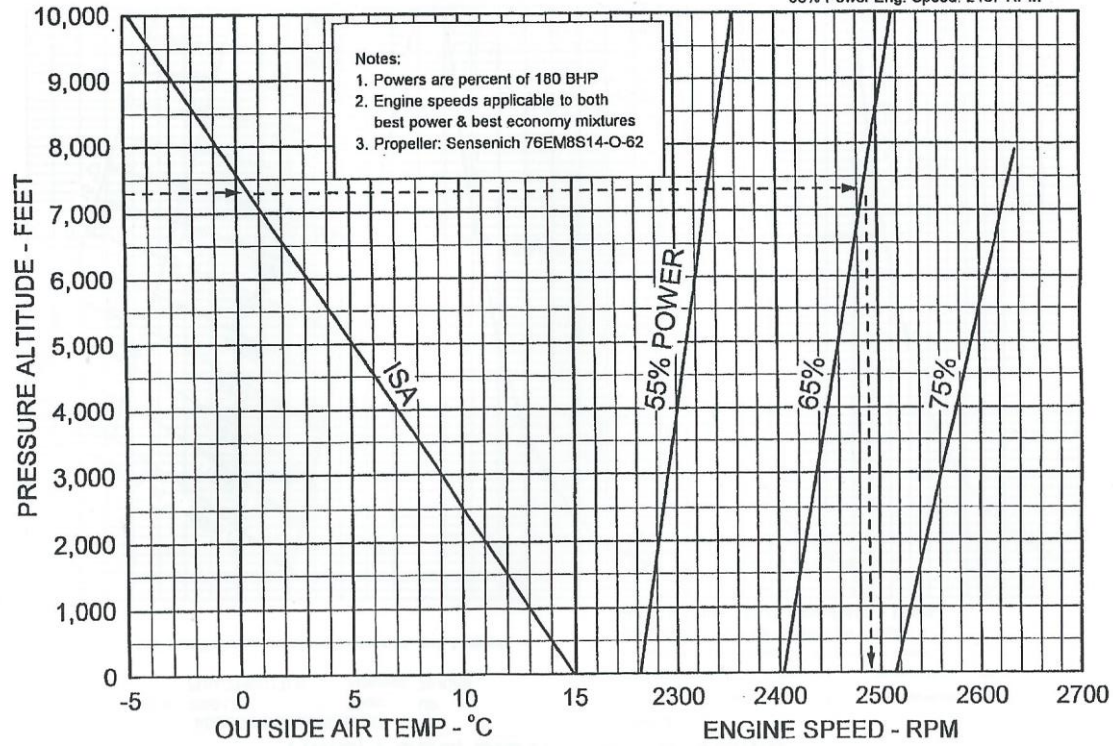

ENGINE PERFORMANCE
Figure 5-19

Engine / Cruise Performance for Non-ISA OAT*					
RPM for Constant 55% Power					
Fuel Flow: Best Economy Mixture, 8.2 GPH					
Pressure Altitude Feet	Indicated Outside Air Temperature			Engine Speed RPM	True Air Speed Knots **
	°C	°C	°F		
Sea Level	ISA-15	0	32	2245	105
	ISA	15	59	2265	
	ISA +10	25	77	2275	
	ISA +20	35	95	2285	
	ISA +30	45	113	2295	
2000	ISA -15	-4	25	2265	106
	ISA	11	52	2280	
	ISA +10	21	70	2295	
	ISA +20	31	88	2305	
	ISA +30	41	106	2315	
4000	ISA -15	-8	18	2285	106
	ISA	7	45	2300	
	ISA +10	17	63	2315	
	ISA +20	27	81	2325	
	ISA +30	37	99	2335	
6000	ISA -15	-12	10	2305	107
	ISA	3	37	2320	
	ISA +10	13	55	2330	
	ISA +20	23	73	2345	
	ISA +30	33	91	2355	
8000	ISA -15	-16	3	2320	107
	ISA	-1	30	2340	
	ISA +10	9	48	2350	
	ISA +17.5	16.5	62	2360	
9000	ISA -15	-18	0	2330	107
	ISA	-3	27	2350	
	ISA +8.5	5.5	42	2360	
10000	ISA -15	-20	-4	2340	107
	ISA	-5	23	2360	

NOTE: * Aircraft weight 2550 Lbs., Wheel pants and strut fairings installed
 ** Subtract 3 KTAS if wheel pants are removed.

ENGINE/CRUISE PERFORMANCE (55%)

Figure 5-20

**SECTION 5
PERFORMANCE**

PA-28-181, ARCHER III

Engine / Cruise Performance for Non-ISA OAT*					
RPM for Constant 65% Power					
Fuel Flow: Best Economy Mixture, 9.5 GPH					
Pressure Altitude Feet	Indicated Outside Air Temperature			Engine Speed RPM	True Air Speed Knots **
	°C	°C	°F		
Sea Level	ISA -15	0	32	2385	113
	ISA	15	59	2405	
	ISA +10	25	77	2415	
	ISA +20	35	95	2430	
	ISA +30	45	113	2440	
2000	ISA -15	-4	25	2405	114
	ISA	11	52	2425	
	ISA +10	21	70	2440	
	ISA +20	31	88	2450	
	ISA +30	41	106	2465	
4000	ISA -15	-8	18	2430	115
	ISA	7	45	2450	
	ISA +10	17	63	2460	
	ISA +20	27	81	2475	
	ISA +30	37	99	2485	
6000	ISA -15	-12	10	2450	116
	ISA	3	37	2470	
	ISA +10	13	55	2485	
	ISA +20	23	73	2495	
	ISA +30	33	91	2510	
8000	ISA -15	-16	3	2475	117
	ISA	-1	30	2495	
	ISA +10	9	48	2505	
	ISA +17.5	16.5	62	2515	
	ISA -15	-18	0	2485	
ISA	-3	27	2505		
ISA +8.5	5.5	42	2515		
10000	ISA -15	-20	-4	2495	118
	ISA	-5	23	2515	

NOTE: * Aircraft weight 2550 Lbs., Wheel pants and strut fairings installed
 ** Subtract 3 KTAS if wheel pants are removed.

ENGINE/CRUISE PERFORMANCE (65%)

Figure 5-20a

Engine / Cruise Performance for Non-ISA OAT*
RPM for Constant 75% Power
Fuel Flow: Best Economy Mixture, 11.0 GPH

Pressure Altitude Feet	Indicated Outside Air Temperature			Engine Speed RPM	True Air Speed Knots **
	°C	°C	°F		
Sea Level	ISA-15	0	32	2485	119
	ISA	15	59	2515	
	ISA +10	25	77	2535	
	ISA +20	35	95	2550	
	ISA +30	45	113	2565	
2000	ISA -15	-4	25	2520	121
	ISA	11	52	2545	
	ISA +10	21	70	2565	
	ISA +20	31	88	2580	
	ISA +30	41	106	2600	
3000	ISA -15	-6	21	2535	122
	ISA	9	48	2560	
	ISA +10	19	66	2580	
	ISA +20	29	84	2595	
	ISA +30	39	102	2615	
4000	ISA -15	-8	18	2550	123
	ISA	7	45	2575	
	ISA +10	17	63	2595	
	ISA +20	27	81	2610	
	ISA +30	37	99	2630	
5000	ISA -15	-10	14	2565	124
	ISA	5	41	2590	
	ISA +10	15	59	2610	
	ISA +20	25	77	2625	
	ISA +25	30	86	2635	
6000	ISA -15	-12	10	2580	125
	ISA	3	37	2605	
	ISA +10	13	55	2625	
	ISA +15	18	64	2635	
7000	ISA -15	-14	6.8	2595	126
	ISA	1	34	2625	
	ISA +7.5	8.5	47	2635	

NOTE: * Aircraft weight 2550 Lbs., Wheel pants and strut fairings installed
 ** Subtract 3 KTAS if wheel pants are removed.

ENGINE/CRUISE PERFORMANCE (75%)

Figure 5-20b

THIS PAGE INTENTIONALLY LEFT BLANK

SPEED POWER
OAT = ISA 2550 LBS GROSS WT. SENSENICH 76EM8S14-0-62 PROP

Fuel Flow	Gal. per Hour
Power Mixture	
75 % Best Pwr	13.5
65 % Best Econ	9.5
55 % Best Econ	8.2
Powers are Percents of 180 BHP	

EXAMPLE:
Cruise Pressure Alt 7375 ft
Temperature: ISA
Cruise Speed @ 65 % 117 Knots

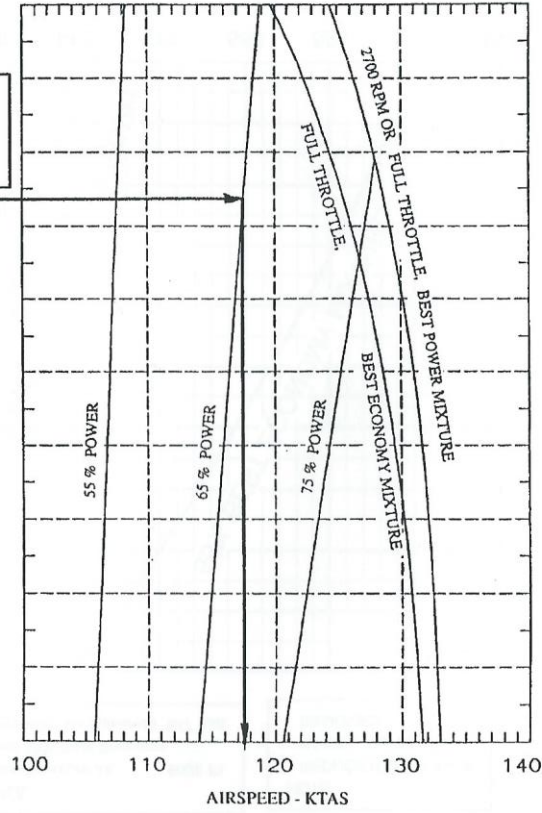
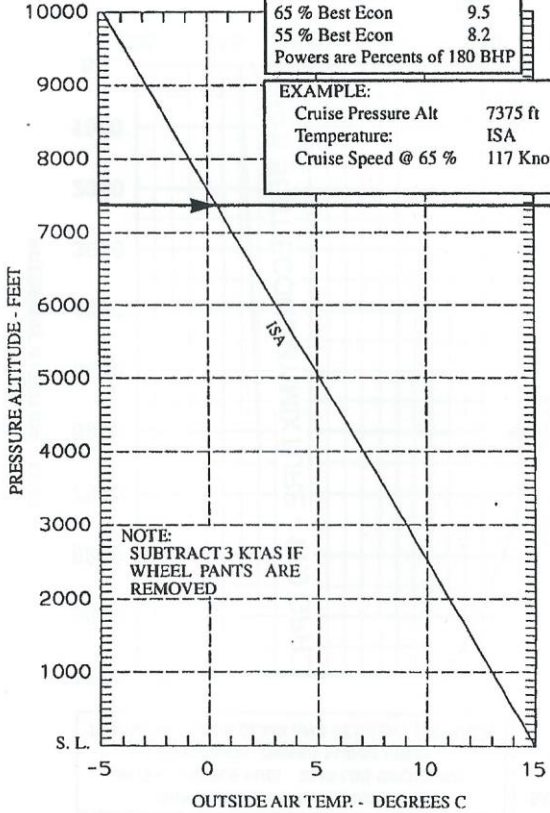

NOTE:
SUBTRACT 3 KTAS IF
WHEEL PANTS ARE
REMOVED

SPEED POWER
Figure 5-21

NOTE:
REDUCE RANGE 3% IF
WHEEL PANTS ARE
REMOVED

EXAMPLE:
Cruise Pressure Alt. 6000 Ft.
Power 65% Best Economy
Range with No Reserves 547 n.m.

RANGE WITHOUT 45 MIN. RESERVE
48 GAL USABLE FUEL 2550 LBS GROSS WT.
SENENICH 76EM8S14-0-62 PROP
RANGE INCLUDES CLIMB AND DESCENT DISTANCE

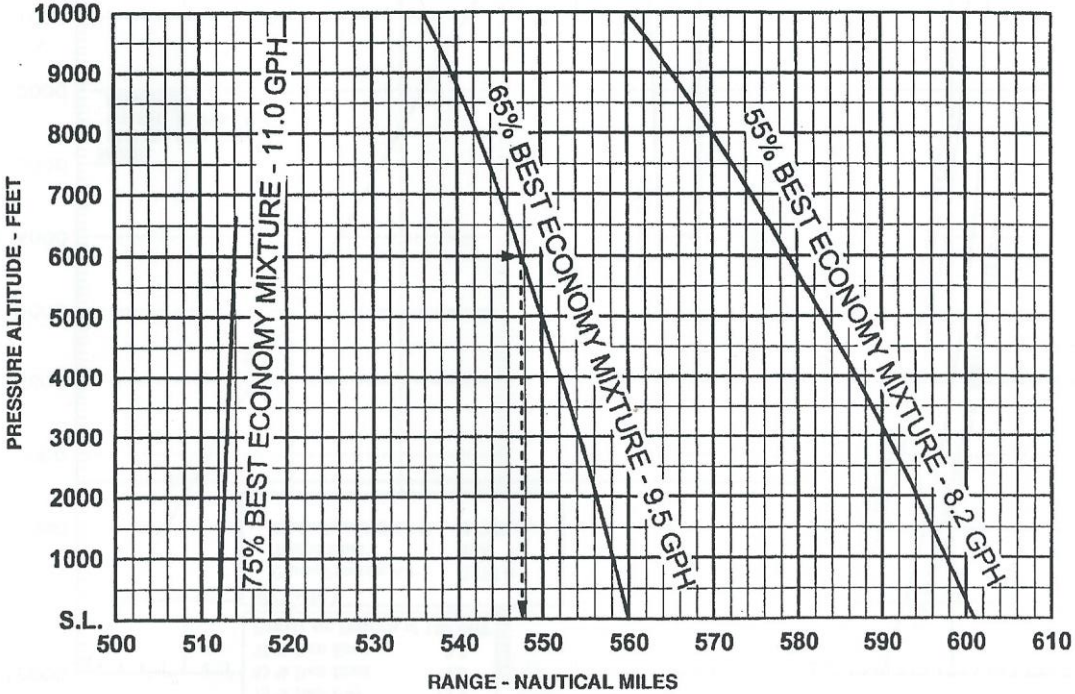

RANGE (NO RESERVE)
Figure 5-27

NOTE:
REDUCE RANGE 3% IF
WHEEL PANTS ARE
REMOVED

EXAMPLE:
Cruise Pressure Alt. 6000 Ft.
Power 65% Best Economy
Range with Reserves 472 n.m.

RANGE WITH 45 MIN. RESERVE
48 GAL USABLE FUEL 2550 LBS GROSS WT.
SENENICH 76EM8S14-0-62 PROP
RANGE INCLUDES CLIMB AND DESCENT DISTANCE
RESERVE FUEL = 45 MIN. AT 55% POWER

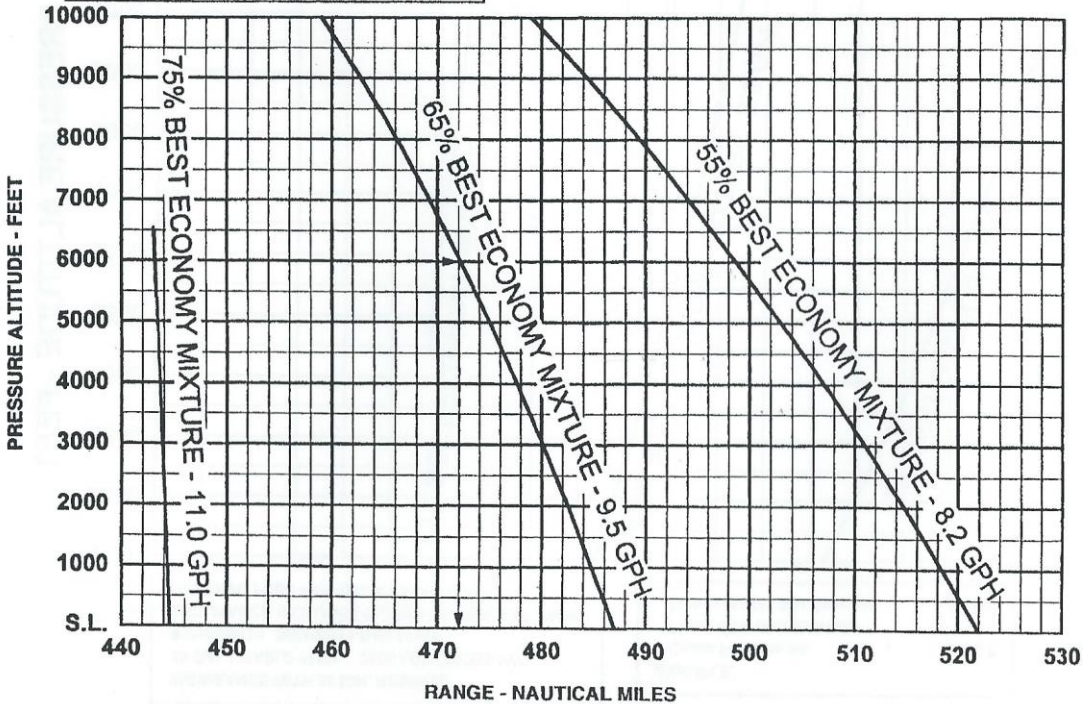

RANGE (45 MIN. RESERVE)
Figure 5-27a

ENDURANCE WITH 45 MIN. RESERVE
 48 GAL USABLE FUEL 2550 LBS GROSS WT.
 SENENICH 76EM8S14-0-62 PROP
 ENDURANCE INCLUDES CLIMB AND DESCENT TIMES
 RESERVE FUEL = 45 MIN. AT 55% POWER

EXAMPLE:
 Cruise Pressure Alt. 6000 ft
 Power 65% Best Economy
 Endurance (45 Min. Reserve) 4.1 Hrs

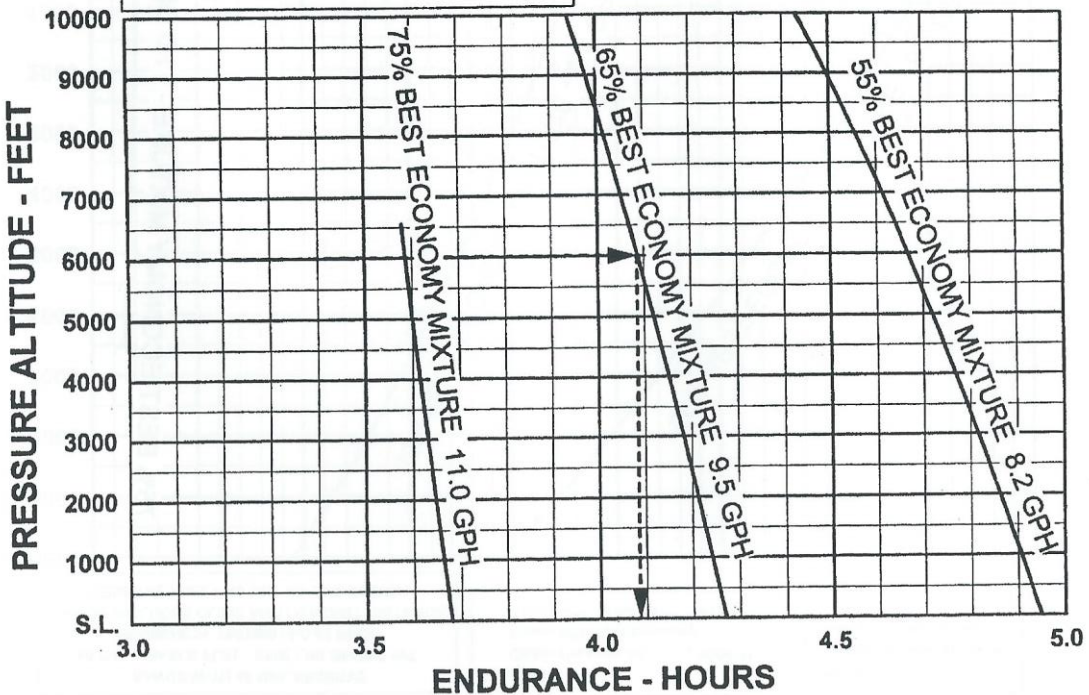

ENDURANCE (45 MIN. RESERVE)
 Figure 5-29

EXAMPLE:
Cruise Pressure Alt. 6000 ft
Power 65% Best Economy
Endurance (No Reserve) 4.7 Hrs

ENDURANCE WITH NO RESERVE
48 GAL USABLE FUEL 2550 LBS GROSS WT.
SENENICH 76EM8S14-0-62 PROP
ENDURANCE INCLUDES CLIMB AND DESCENT TIMES

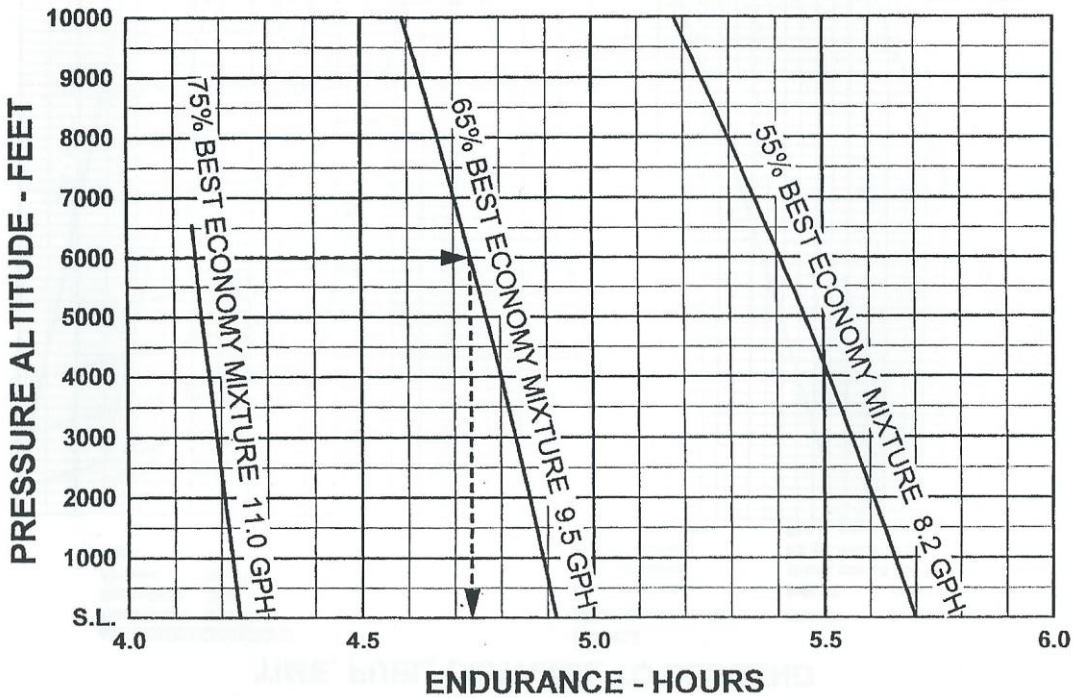

ENDURANCE (NO RESERVE)
Figure 5-29a

TIME, FUEL, DISTANCE TO DESCEND

ASSOCIATED CONDITIONS

Gross Weight: 2550 LB
 Engine RPM: 2500
 Airspeed: 122 KIAS
 Flaps: UP

EXAMPLE

Depart Airport Press Alt. 2500 FT. Temperature: 21 °C
 Cruise Press Alt.: 6000 FT. Cruise OAT: 15 °C
 Time to Descend: 16 min. minus 6 min. = 10 min
 Fuel to Descend: 3.2 gal. minus 1.3 gal = 1.9 gal
 Distance to Descend: 33 n.m. minus 13 n.m. = 20 n.m.

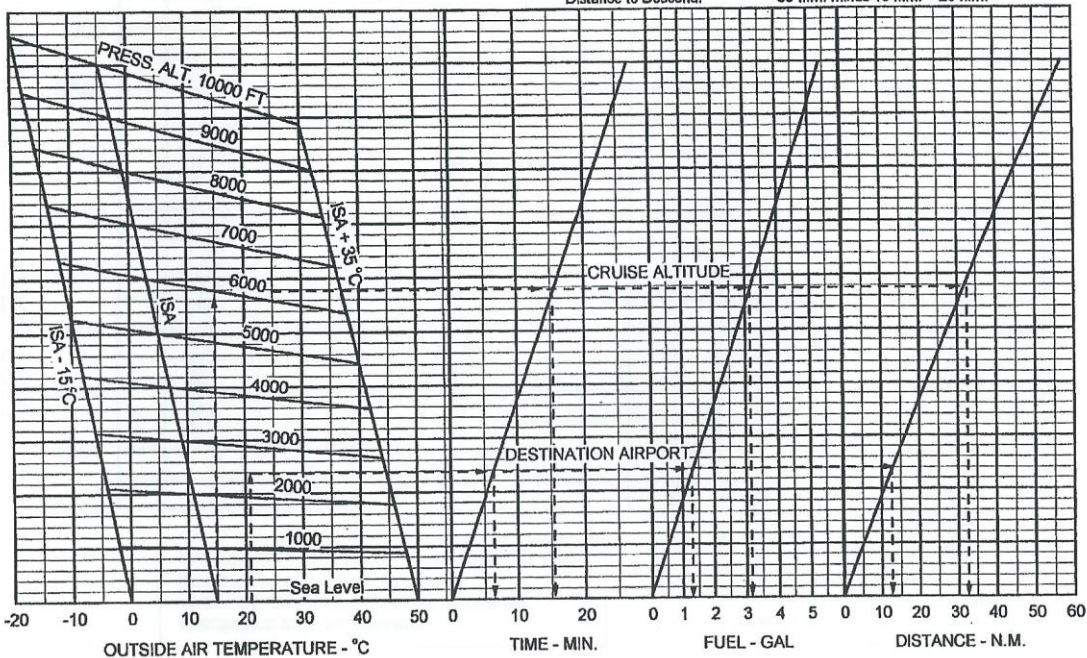

TIME, DISTANCE AND FUEL TO DESCEND

Figure 5-31

GLIDE RANGE
 POWER OFF, FLAP UP, 76 KIAS
 2,250 LB GROSS WT., NO WIND

EXAMPLE:

Glide Distance from 6,000 ft Cruise Alt. 11.2 nm
 Glide Distance from 2,600 ft Terrain
 above sea level 4.8 nm
 Glide Distance from Cruise Altitude
 to Terrain Altitude 11.2 minus 4.8 = 6.4 nm

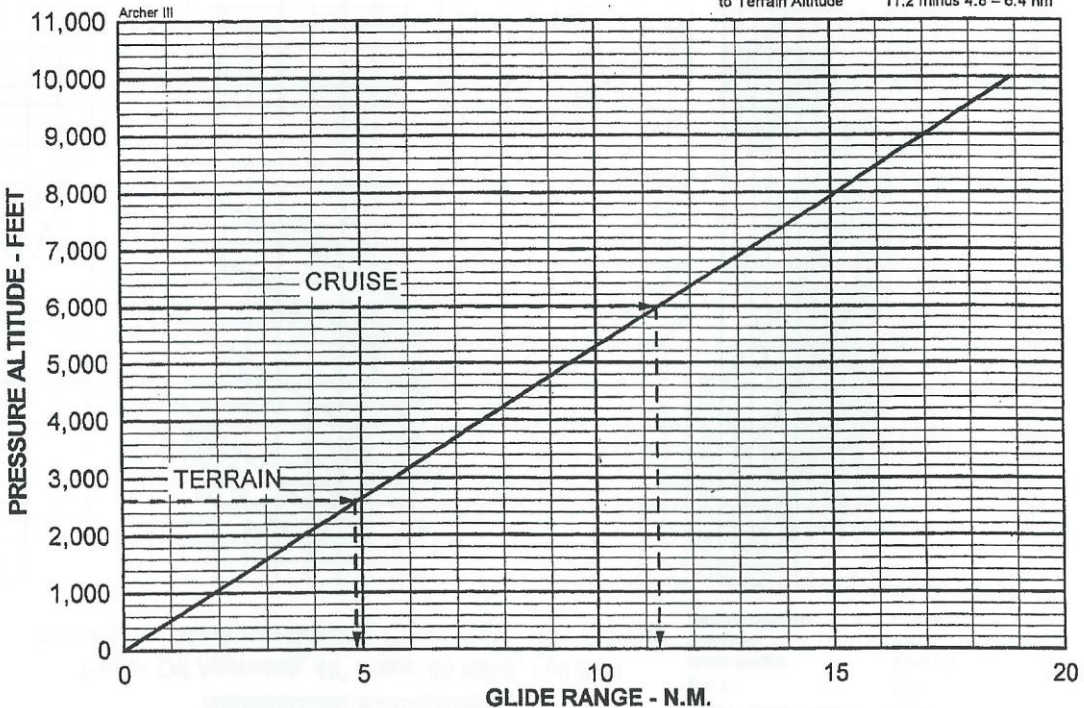

GLIDE RANGE

Figure 5-33

LANDING PERFORMANCE

ASSOCIATED CONDITIONS

Power Off Approach, 40° Flaps, 66 KIAS, Full Stall
Touchdown, Maximum Braking, Paved, Level, Dry Runway

EXAMPLE:

Airport Pressure Altitude: 2,500 FT.
O.A.T.: 21°C
Gross Weight: 2,240 LB.
Headwind: 5 KT.
Landing Distance: 1,290 FT.

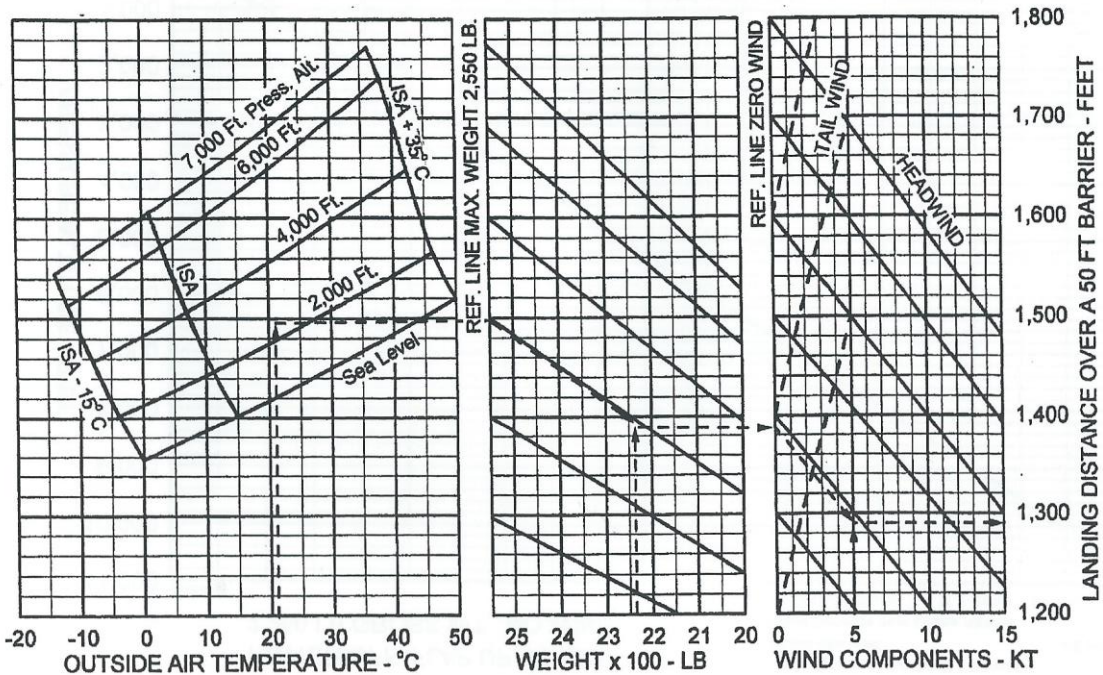

LANDING PERFORMANCE

Figure 5-35

LANDING GROUND ROLL ASSOCIATED CONDITIONS

Power Off Approach, 40° Flaps, Full Stall Touchdown
Maximum Braking, Paved, Level, Dry Runway

EXAMPLE:
 Airport Pressure Altitude: 2,500 Ft.
 O.A.T.: 21°C
 Gross Weight: 2,240 Lb.
 Headwind: 5 Kt.
 Landing Ground Roll: 820 Ft.

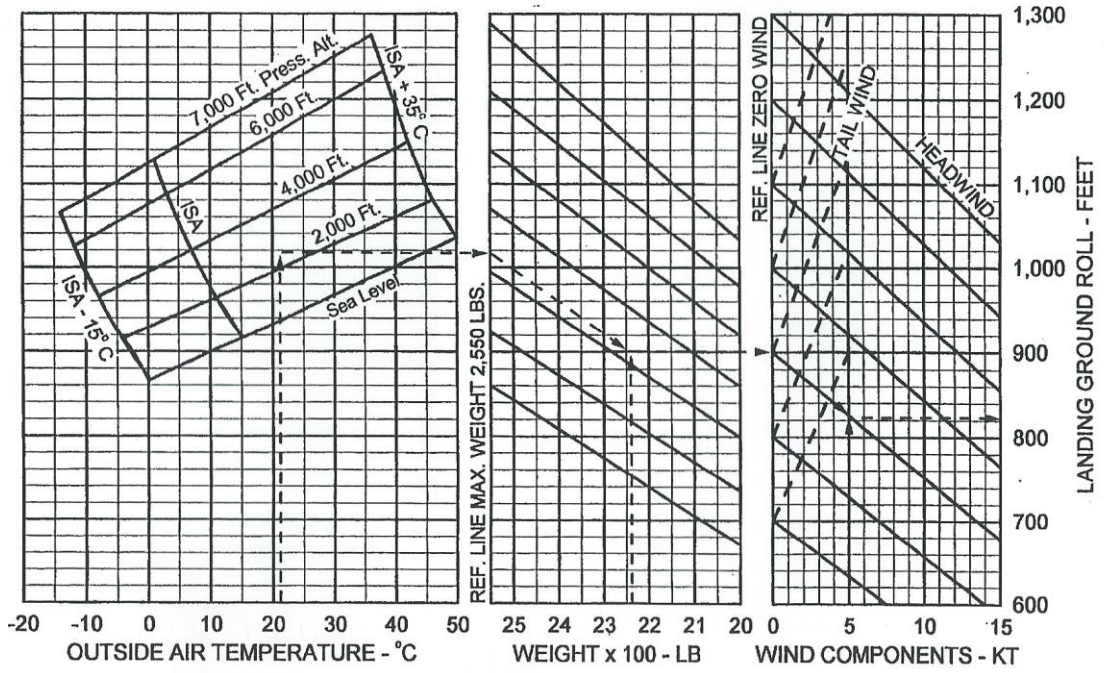

LANDING GROUND ROLL

Figure 5-37

ISSUED: JULY 12, 1995
 REVISED: MARCH 31, 1998

REPORT: VB-1611
 5-33

THIS PAGE INTENTIONALLY LEFT BLANK

TABLE OF CONTENTS
SECTION 6
WEIGHT AND BALANCE

Paragraph No.		Page No.
6.1	General	6-1
6.3	Airplane Weighing Procedure	6-2
6.5	Weight and Balance Data and Record	6-5
6.7	Weight and Balance Determination for Flight	6-9

THIS PAGE INTENTIONALLY LEFT BLANK

SECTION 6

WEIGHT AND BALANCE

6.1 GENERAL

In order to achieve the performance and flying characteristics which are designed into the airplane, it must be flown with the weight and center of gravity (C.G.) position within the approved operating range (envelope). Although the airplane offers flexibility of loading, it cannot be flown with the maximum number of adult passengers, full fuel tanks and maximum baggage. With the flexibility comes responsibility. The pilot must ensure that the airplane is loaded within the loading envelope before he makes a takeoff.

Misloading carries consequences for any aircraft. An overloaded airplane will not take off, climb or cruise as well as a properly loaded one. The heavier the airplane is loaded, the less climb performance it will have.

Center of gravity is a determining factor in flight characteristics. If the C.G. is too far forward in any airplane, it may be difficult to rotate for takeoff or landing. If the C.G. is too far aft, the airplane may rotate prematurely on takeoff or tend to pitch up during climb. Longitudinal stability will be reduced. This can lead to inadvertent stalls and even spins; and spin recovery becomes more difficult as the center of gravity moves aft of the approved limit.

A properly loaded airplane, however, will perform as intended. Before the airplane is licensed, a basic empty weight and C.G. location is computed (basic empty weight consists of the standard empty weight of the airplane plus the optional equipment). Using the basic empty weight and C.G. location, the pilot can easily determine the weight and C.G. position for the loaded airplane by computing the total weight and moment and then determining whether they are within the approved envelope.

The basic empty weight and C.G. location are recorded in the Weight and Balance Data Form (Figure 6-5) and the Weight and Balance Record (Figure 6-7). The current values should always be used. Whenever new equipment is added or any modification work is done, the mechanic responsible for the work is required to compute a new basic empty weight and C.G. position and to write these in the Aircraft Log Book and the Weight and Balance Record. The owner should make sure that it is done.

A weight and balance calculation is necessary in determining how much fuel or baggage can be boarded so as to keep within allowable limits. Check calculations prior to adding fuel to insure against improper loading.

The following pages are forms used in weighing an airplane in production and in computing basic empty weight, C.G. position, and useful load. Note that the useful load includes usable fuel, baggage, cargo and passengers. Following this is the method for computing takeoff weight and C.G.

6.3 AIRPLANE WEIGHING PROCEDURE

At the time of licensing, Piper provides each airplane with the basic empty weight and center of gravity location. This data is supplied by Figure 6-5.

The removal or addition of equipment or airplane modifications can affect the basic empty weight and center of gravity. The following is a weighing procedure to determine this basic empty weight and center of gravity location:

(a) Preparation

- (1) Be certain that all items checked in the airplane equipment list are installed in the proper location in the airplane.
- (2) Remove excessive dirt, grease, moisture, foreign items such as rags and tools from the airplane before weighing.
- (3) Defuel airplane. Then open all fuel drains until all remaining fuel is drained. Operate engine on each tank until all undrainable fuel is used and engine stops. Then add the unusable fuel (2.0 gallons total, 1.0 gallons each wing).

CAUTION

Whenever the fuel system is completely drained and fuel is replenished it will be necessary to run the engine for a minimum of 3 minutes at 1000 RPM on each tank to ensure no air exists in the fuel supply lines.

- (4) Fill with oil to full capacity.
- (5) Place pilot and copilot seats in fourth (4th) notch, aft of forward position. Put flaps in the fully retracted position and all control surfaces in the neutral position. Tow bar should be in the proper location and all entrance and baggage doors closed.
- (6) Weigh the airplane inside a closed building to prevent errors in scale readings due to wind.

(b) Leveling

- (1) With airplane on scales, block main gear oleo pistons in the fully extended position.
- (2) Level airplane (refer to Figure 6-3) deflating nose wheel tire, to center bubble on level.

(c) Weighing - Airplane Basic Empty Weight

- (1) With the airplane level and brakes released, record the weight shown on each scale. Deduct the tare, if any, from each reading.

Scale Position and Symbol	Scale Reading	Tare	Net Weight
Nose Wheel (N)			
Right Main Wheel (R)			
Left Main Wheel (L)			
Basic Empty Weight, as Weighed (T)			

WEIGHING FORM

Figure 6-1

(d) Basic Empty Weight Center of Gravity

(1) The following geometry applies to the PA-28-181 airplane when it is level. Refer to Leveling paragraph 6.3 (b).

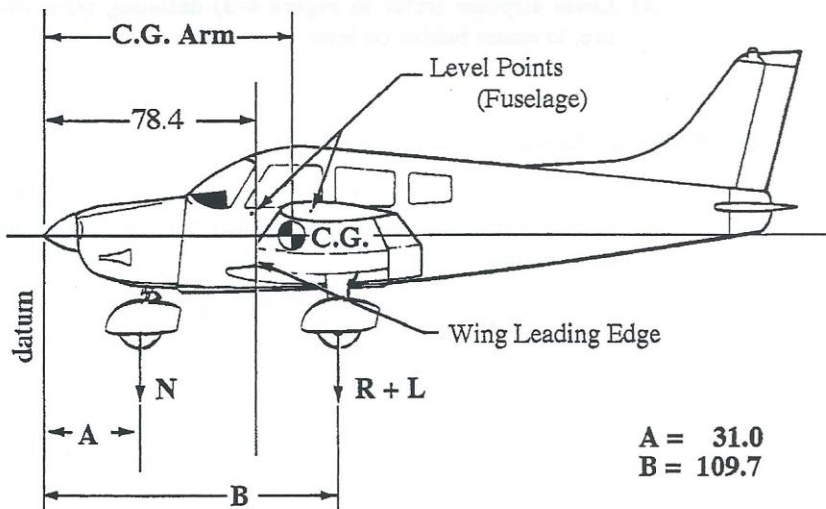

LEVELING DIAGRAM

Figure 6-3

- (2) The basic empty weight center of gravity (as weighed including optional equipment, full oil and unusable fuel) can be determined by the following formula:

$$\text{C.G. Arm} = \frac{N(A) + (R+L)(B)}{T} \quad \text{inches}$$

$$\text{Where: } T = N + R + L$$

6.5 WEIGHT AND BALANCE DATA AND RECORD

The Basic Empty Weight, Center of Gravity Location and Useful Load listed in Figure 6-5 are for the airplane as licensed at the factory. These figures apply only to the specific airplane serial number and registration number shown.

The basic empty weight of the airplane as licensed at the factory has been entered in the Weight and Balance Record (Figure 6-7). This form is provided to present the current status of the airplane basic empty weight and a complete history of previous modifications. Any change to the permanently installed equipment or modification which affects weight or moment must be entered in the Weight and Balance Record.

MODEL PA-28-181 ARCHER III

Airplane Serial Number **2843426**
 Registration Number **SE-ILV**
 Date **02/12/01**

AIRPLANE BASIC EMPTY WEIGHT

Item	Weight (Lbs)	C.G. Arm (Inches Aft of Datum)	= Moment (In-Lbs)
Actual	1682.2	87.5548	147284.7
Standard Empty Weight* Computed			
Optional Equipment	73.0	102.2918	7467.3
Basic Empty Weight	1755.2	88.1677	154752.0

*The standard empty weight includes full oil capacity and 2.0 gallons of unusable fuel.

AIRPLANE USEFUL LOAD

(Ramp Weight) - (Basic Empty Weight) = Useful Load

Normal Category (2558 lbs) - (**1755.2** lbs) = **802.8** lbs.

Utility Category (2138 lbs) - (**1755.2** lbs) = **382.8** lbs.

THIS BASIC EMPTY WEIGHT, C.G. AND USEFUL LOAD ARE FOR THE AIRPLANE AS LICENSED AT THE FACTORY. REFER TO APPROPRIATE AIRCRAFT RECORD WHEN ALTERATIONS HAVE BEEN MADE.

WEIGHT AND BALANCE DATA FORM

Figure 6-5

PA-28-181		Serial Number	2843426	Registration Number			SE-ILV	Page Number	
Date	Item No.	Description of Article or Modification	Added (+) Removed (-)	Weight Change			Running Basic Empty Weight		
				Wt. (Lb.)	Arm (In.)	Moment /100	Wt. (Lb.)	Moment /100	
02/12/01		As licensed					1755.2	154752.0	

WEIGHT AND BALANCE RECORD

Figure 6-7

ISSUED: JULY 12, 1995

REPORT: VB-1611

6-7

PA-28-181		Serial Number		Registration Number			Page Number	
Date	Item No.	Description of Article or Modification	Added (+) Removed (-)	Weight Change			Running Basic Empty Weight	
				Wt. (Lb.)	Arm (In.)	Moment /100	Wt. (Lb.)	Moment /100
		As licensed						

WEIGHT AND BALANCE RECORD (cont)

Figure 6-7 (cont)

6.7 WEIGHT AND BALANCE DETERMINATION FOR FLIGHT

- (a) Add the weight of all items to be loaded to the basic empty weight.
- (b) Use the Loading Graph (Figure 6-13) to determine the moment of all items to be carried in the airplane.
- (c) Add the moment of all items to be loaded to the basic empty weight moment.
- (d) Divide the total moment by the total weight to determine the C.G. location.
- (e) By using the figures of item (a) and item (d) (above), locate a point on the C.G. range and weight graph (Figure 6-15). If the point falls within the C.G. envelope, the loading meets the weight and balance requirements.

	Arm Aft		
	Weight (Lbs)	Datum (Inches)	Moment (In-Lbs)
Basic Empty Weight	1590.0	87.5	139125
Pilot and Front Passenger	340.0	80.5	27370
Passengers (Rear Seats)*	340.0	118.1	40154
Fuel (48 Gallon Maximum)	288.0	95.0	27360
Baggage (200 Lbs. Maximum)*		142.8	
Ramp Weight (2558 Lbs. Normal, 2138 Lbs. Utility Maximum)	2558	91.5	234009
Fuel Allowance			
For Engine Start, Taxi and Run Up	-8	95.0	-760
Takeoff Weight (2550 Lbs. Normal, 2130 Lbs. Utility Maximum)	2550.0	91.5	233249

The center of gravity (C.G.) of this sample loading problem is at 91.5 inches aft of the datum line. Locate this point (91.5) on the C.G. range and weight graph. Since this point falls within the weight - C.G. envelope, this loading meets the weight and balance requirements.

IT IS THE RESPONSIBILITY OF THE PILOT AND AIRCRAFT OWNER TO ENSURE THAT THE AIRPLANE IS LOADED PROPERLY.

*Utility Category Operation - No baggage or rear passengers allowed.

SAMPLE LOADING PROBLEM (NORMAL CATEGORY)

Figure 6-9

SECTION 6
WEIGHT AND BALANCE

PA-28-181, ARCHER III

	Weight (Lbs)	Arm Aft Datum (Inches)	Moment (In-Lbs)
Basic Empty Weight			
Pilot and Front Passenger		80.5	
Passengers (Rear Seats)*		118.1	
Fuel (48 Gallon Maximum)		95.0	
Baggage (200 Lbs. Maximum)*		142.8	
Ramp Weight (2558 Lbs. Normal, 2138 Lbs. Utility Maximum)			
Fuel Allowance For Engine Start, Taxi and Run Up	-8	95.0	-760
Takeoff Weight (2550 Lbs. Normal, 2130 Lbs. Utility Maximum)			

Totals must be within approved weight and C.G. limits. It is the responsibility of the airplane owner and the pilot to insure that the airplane is loaded properly. The Basic Empty Weight C.G. is noted on the Weight and Balance Data Form (Figure 6-5). If the airplane has been altered, refer to the Weight and Balance Record for this information.

*Utility Category Operation - No baggage or rear passengers allowed.

WEIGHT AND BALANCE LOADING FORM

Figure 6-11

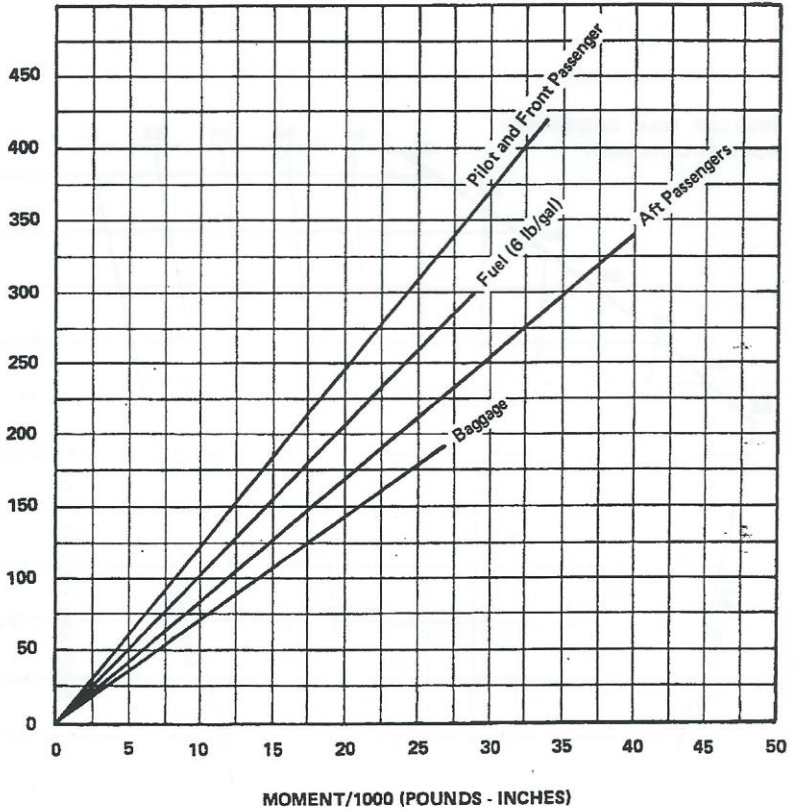

LOADING GRAPH

Figure 6-13

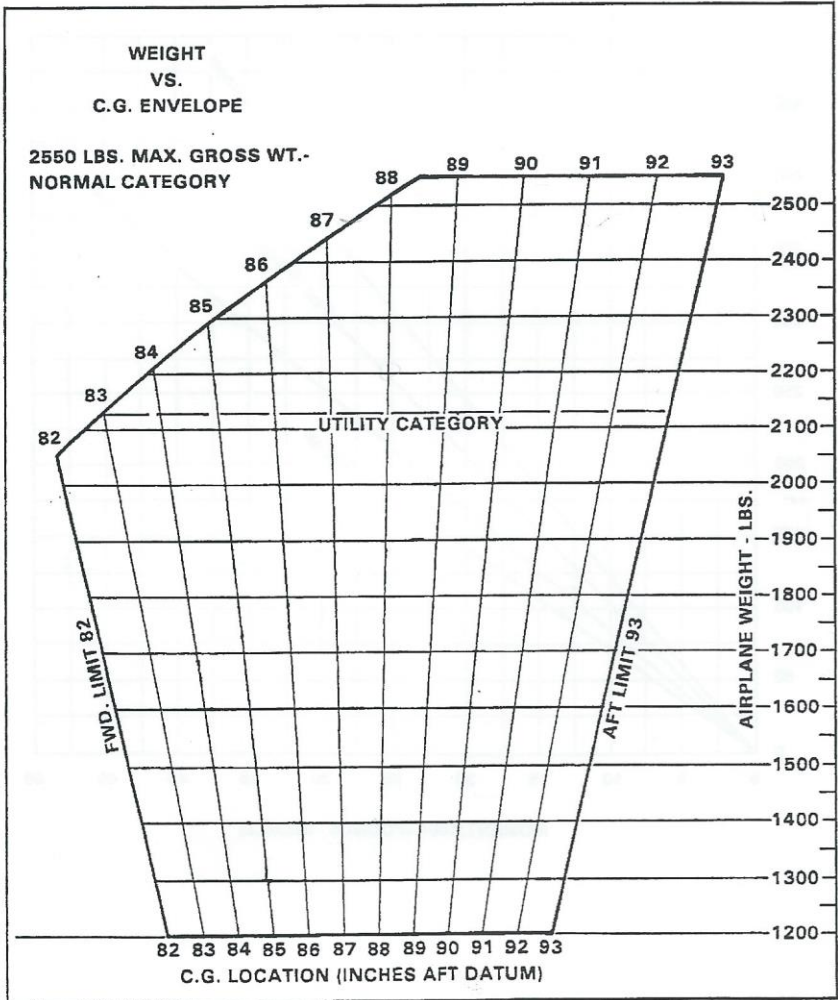

C.G. RANGE AND WEIGHT

Figure 6-15



THE NEW PIPER AIRCRAFT, INC

PA-28-181, ARCHER III
EQUIPMENT LIST
S/N 2843415 and UP

EQUIPMENT LIST

The following is a list of standard and optional equipment for the PA-28-181 Archer III. Optional equipment items marked with an X are installed on the airplane. All items are as described below at the time of licensing by the manufacturer. The New Piper Aircraft, Inc. will not revise this equipment list once the aircraft is licensed. It is the owner's responsibility to retain and amend this equipment list to reflect changes in equipment installed in this airplane. Unless otherwise indicated, the installation certification basis for the equipment included in this list is the aircraft's approved type design.

THE NEW PIPER AIRCRAFT INC.

PA-28-181, ARCHER III

SERIAL NO. 2843426 REGISTRATION NO. SE-ILV DATE 02/12/01

Item No.	Item	Weight (Pounds)	Arm (In.) Aft Datum	Moment (Lbs.-In.)
(a) Propeller and Propeller Accessories				
1.	Propeller, Sensenich 76EM8S14-0-62, Piper PS 50077-91 includes Propeller extension and Propeller bolts, Cert. Basis -TC P4EA	44.2	2.8	123.8
3.	Spinner, Piper Drawing 83349-2			
	a. Bulkhead-Aft	1.5	3.3	5.0
	b. Dome and Forward Bulkhead	3.7	-0.4	-1.5
(b) Engine and Engine Accessories, Fuel and Oil Systems				
11.	Engine, Textron Lycoming Model O-360-A4M, Piper Drawing 62941-18 Cert. Basis - TC E286	281.0	20.9	5872.9
13.	Oil Filter, Cert. Basis - TC E286			
	a. Lycoming 75528, (AC OF5578770)	3.3	35.5	117.2
	b. Lycoming LW-13743, (Champion CH-48110)	2.8	35.5	99.4
15.	Alternator, 70 Amp, Piper Drawing 99109-13 (Includes belts and hoses) Electro Systems Inc. ES4032 , Lycoming #32C21997	12.0	12.8	153.6
17.	Engine Driven Fuel Pump, Lycoming Drawing 73297, 74082, 75148 or 75246 Cert. Basis-TC E286	1.7	36.3	61.7
19.	Electric Fuel Pump, Facet 476088	1.8	45.0	81.0
21.	Fuel Valve, Piper Drawing 66945 (System Components Corp., SP-2378-B3 or Allen Aircraft Products Inc., 6S122)	0.4	61.9	24.8
23.	Oil Cooler, Niagara N.D.M.20002A, Piper Drawing 85472-8 (wet)	2.6	31.8	82.7
25.	Air Filter, PMA 638873	0.9	27.0	24.3
27.	Starter - 24 volt Lycoming, ESI MHB4016 (Lycoming # LW15572) Cert. Basis TC E286	18.0	13.8	248.4

REVISED: 1/16/01

240-0177
1 of 24



THE NEW PIPER AIRCRAFT, INC

PA-28-181, ARCHER III
EQUIPMENT LIST
S/N 2843415 and UP

Item No.	Item	Weight (Pounds)	Arm (In.) Aft Datum	Moment (Lbs.-In.)
(b) Engine and Engine Accessories, Fuel and Oil Systems -continued				
29.	Primer System, Piper Drawing 89367-4	1.2	36.0	43.2
(c) Landing Gear and Brakes				
35.	Main Landing Gear Cleveland Aircraft Products Wheel Assembly (2) 40-86B, Piper PS50035-9 Brake Assembly 30-55 (2), Piper PS50121-1, Cert. Basis-TSO C26a 6.00 x 6 Type III 4 Ply Rating Tire, Piper PS50119-11 and Tubes (2), Piper PS50119-101 Cert. Basis - TSO C62d	38.8	109.6	4252.5
37.	Nose Wheel Assembly a. Cleveland Aircraft Products Wheel Assembly 40-56B, Piper PS50035-23, Cert. Basis - TSO C26a b. 6.00-6 Type III 4 Ply Rating Tire, Piper PS50119-11 and Tube PS50119-101 Cert. Basis -TSO C62d	4.3 11.8	31.0 31.0	133.3 365.8
39.	Hand Brake Master Cylinder, Piper Drawing 65842 (Cleveland Aircraft Products 10-22)	0.6	60.9	36.5
41.	Toe Brake Cylinders a. Cleveland Aircraft Products 10-27 b. Gar-Kenyon Instruments 17000	0.7 0.4	53.0 53.0	37.1 21.2
43.	Nose Wheel Fairing Installation, Piper Drawing 37896-3	3.8	36.3	137.9
45.	Main Wheel Fairings Installation (2), Piper Drawing 79893-2 LH,-3 RH	17.0	113.6	1931.2
(d) Electrical Equipment				
51.	Voltage Regulator, Piper Drawing 68804-5	0.4	51.9	20.8
53.	Battery, 28 volt Gill G-243	28.0	171.7	4807.6
55.	Starter Relay-28 v (RBM Controls 70-117224-3), Piper Drawing 26898-5	0.8	180.0	144.0
57.	Stall Warning Devices (Safe Flight C52207), Piper Drawing 85370	0.2	80.2	16.0
59.	Stall Warning Horn (Safe Flight 53534-3), Piper Drawing 35214-9	0.2	58.8	11.8
61.	Radio Master Switch Relay 6041H299, Piper Drawing 39870-9	0.5	59.5	29.8
63.	Instrument Panel Lights Installation, Piper Drawing 85370	0.3	62.8	18.8
67.	Cabin Light, Piper Drawing 89875-2	0.3	99.0	29.7
69.	Landing Light/Taxi Light Installation, Piper Drawing 85402-2,-3 (G.E. 4594)(2)	1.8	95.6	172.1
71.	Navigation Lights (Wings)(2) Red/White and Green /White With White Strobe, Whelen Power Supply A413HDA-CF-14/28, Piper Drawing 36789-48	6.6	106.6	703.7
79.	Heated Pitot Installation, Piper Drawing 35493-20	0.4	100.0	40.0



Item No.	Item	Weight (Pounds)	Arm (In.) Aft Datum	Moment (Lbs.-In.)
(d) Electrical Equipment				
81.	Auxiliary Power Receptacle, Piper Drawing 104462-002			
	a. Receptacle MS3506-1 Piper Code 484-125, Piper Drawing 44259-001	0.88	179.36	157.84
	b. Bracket, Harness, Relay and Hardware, Piper Drawing 104462-002	2.46	175.89	432.19
(e) Instruments				
91.	Truspeed, Airspeed Indicator, Piper PS50049-64T2 Cert. Basis -TSO C2b	0.6	61.8	37.1
93.	Altimeter, Piper PS50008-10-2D (United Instruments UI5934-PD-3) Cert. Basis - TSO C10b	0.9	60.9	54.8
95.	Compass, Magnetic, Piper Drawing. 67462-8(Airpath C-2200-L4-1B) Cert. Basis TSO C7c	0.9	64.6	58.1
97.	Tachometer, Piper PS50048-15-1	0.7	61.2	42.8
99.	Oil Press./Cylinder Temp./Oil Temp./ Piper PS50160-7	1.0	62.2	62.2
101.	Fuel Quantity Indicator, Piper PS50161-6	0.5	62.2	31.1
103.	Narco AR-850 Encoder Installation, Piper Drawing 79658-004, Cert. Basis TSO C88(a)			
	a. Narco AR 850 Altitude Reporter 03753-0500, Piper PS50040-30-5, Piper Code 599-012	0.569	51.038	29.041
	b. Narco AR -850 Altitude Reporter Mounting Tray 53873-0102, Piper Code 599-012	0.080	51.038	4.083
	c. Altitude Reporter Hose , tube and hardware Piper Drawing 79658-004	0.136	54.47	7.39
105.	Exhaust Gas Temperature Gauge, Piper PS50159-4-1	0.6	64.4	38.6
107.	Vacuum Installation 85434-2			
	a. Dry Air Pump Parker Hannifin AM215CC, Piper Drawing 79399-3, Piper Code number 461-754	1.90	33.47	63.46
	b. Vacuum Regulator Parker Hannifin ARM-AM-2H3-19, Piper Code 492-240	0.44	48.85	21.47
	c. Hoses, Fittings and Hardware, Piper Drawing 85434-2	2.54	49.33	125.07
109.	Auxiliary Vacuum Pump Installation, Piper Drawing 85387-2			
	a. Standby Auxiliary Vacuum Pump, Parker Hannifin 4A2-1, Piper Code 566-527	7.12	43.88	312.41
	b. Hardware, Parker Hannifin Kit 374-10, Piper Code 566-527	2.01	47.11	94.83
	c. Brackets and Hardware, Piper Drawing 85387-2	2.97	45.06	133.92
111.	Attitude Gyro, Piper Drawing. 99002-9, RCA 22-15, Cert. Basis TSO C4c	2.8	59.9	167.7
113.	Directional Gyro, Piper PS50126-5, Cert. Basis TSO C5c	2.4	59.7	143.3
115.	Rate of Climb, Piper Drawing. 99010-5 (United Instruments UI-7000) Cert. Basis - TSO C8b	0.7	60.9	42.6
117.	Alternate Static Source Installation, Piper Drawing. 35493-20	0.4	61.0	24.4
119.	Turn Coordinator, Piper PS50030-3-5, Cert. Basis TSO C3b	1.2	59.7	71.6
121.	Engine Hour Meter, Piper Drawing. 87346-6	0.3	62.0	18.6



THE NEW PIPER AIRCRAFT, INC

PA-28-181, ARCHER III
EQUIPMENT LIST
S/N 2843415 and UP

Item No.	Item	Weight (Pounds)	Arm (In.) Aft Datum	Moment (Lbs.-In.)
(e) Instruments - continued				
123.	Clock, Piper Drawing. 87347-2	0.4	62.4	25.0
125.	Outside Air temperature Gauge (Rochester 1592-70064) Piper Drawing. 87702-7	0.3	72.6	21.8
127.	Ammeter, Digital, EIL Instruments PM-349 (548-885)	0.3	61.1	18.3
(f) Cabin Interior				
131.	Pilot Adjustable Seat (cloth) with headrest and lumbar support, Piper Drawing. 89026-2, 02585-2 Lumbar Installation	24.46	83.00	2030.18
133.	CoPilot Adjustable Seat (cloth) with headrest and lumbar support, Piper Drawing 89026-3, 02585-3 Lumbar Installation	24.46	82.80	2025.29
135.	Aft Rear Seat (cloth), (right) with headrest, Piper Drawing 89027-3	15.79	123.00	1942.17
137.	Aft Rear Seat (cloth), (left) with headrest, Piper Drawing 89027-2	15.79	123.00	1942.17
139.	Pilot Restraint System, Piper Drawings 76170-7, 79164-011, Cert. Basis TSO - C114/JTTSO-C114			
	a. Pilot Inertia Reel, Schroth 5-01-1F0701, Piper Code 564-897, Piper Drawing 104211-014	1.29	119.50	154.39
	b. Pilot stiffening Sleeve, Schroth 5-01-1F0701, Piper Code 564-897, Piper Drawing 104211-014	0.29	84.00	24.32
141.	CoPilot Restraint System, Piper Drawings 76170-7, 79164-011, Cert. Basis TSO - C114/JTTSO-C114			
	a. CoPilot Inertia Reel, Schroth 5-01-1F5701, Piper Code 564-896, Piper Drawing 104211-015	1.30	119.50	154.87
	b. CoPilot Stiffening Sleeve, Schroth 5-01-1F5701, Piper Code 564-896, Piper Drawing 104211-015	0.29	84.00	24.19
143.	Aft Seat Restraint System (LH), Piper Drawings 76170-7, 79164-012, Cert. Basis TSO - C114/JTTSO-C114			
	a. Aft Seat Inertia Reel, Schroth 5-01-480701, Piper Code 564-895, Piper Drawing 104211-012	1.23	140.30	173.13
	b. Aft Seat Inertia Reel, Schroth 5-01-480701, Piper Code 564-895, Piper Drawing 104211-012	0.26	123.00	31.67
145.	Aft Seat Restraint System (RH), Piper Drawings 76170-7, 79164-012, Cert. Basis TSO - C114/JTTSO-C114			
	a. Aft Seat Inertia Reel, Schroth 5-01-285701, Piper Code 564-893, Piper Drawing 104211-003	1.23	140.30	173.20
	b. Aft Seat Stiffening Sleeve, Schroth 5-01-285701, Piper Code 564-893, Piper Drawing Number 104211-003	0.26	123.00	31.49



THE NEW PIPER AIRCRAFT, INC

PA-28-181, ARCHER III
EQUIPMENT LIST
S/N 2843415 and UP

Item No.	Item	Weight (Pounds)	Arm (In.) Aft Datum	Moment (Lbs.-In.)
(f) Cabin Interior - continued				
149.	Baggage Straps, Piper Drawings 66804-0 & 66805-0	1.3	142.8	185.6
(g) Miscellaneous				
153.	Overhead Vent System with Ground Ventilating Blower Installation (Ram Air Installation) Piper Drawing 36983-17	14.2	168.5	2392.7
155.	Assist Step, Piper Drawing 65384-0	1.8	156.0	280.8
157.	Tow Bar, Piper Drawing 99458-0	1.3	156.0	202.8
159.	Locking Fuel Caps (2), Piper Drawing 39824-3	0.85	93.85	80.10
161.	Fire Extinguisher Installatio, Piper Drawing 82235-2			
	a. Saber Halon 1211-1301 Fire Extinguisher 600 and Installation Hardware	2.1	95.8	201.2
(h) Standard Avionics Equipment				
171.	GNS 430 GPS/Nav/Com, Single with Stormscope and Skywatch Provisions, Single COM/NAV/GPS, Piper Drawing 104479-2			
	a. Garmin GNS430 #1 with mount, connectors and data card, Piper PS50040-40-1, Piper Code 601-214, Cert. Basis - TSO C37d, C38d, C40c, C36e, C34e, C129a	6.48	58.138	376.73424
	b. Cables/harnesses and hardware, Piper Drawing 104479-2	2.00	55.578	111.22
173.	Garmin GI-106 VOR /LOC Indicator, Piper Code 602-239, Cert. Basis-TSO C36c,C40a,C34c	1.02	60.228	61.43
175.	Garmin GTX-327, Transponder Installation with AR-850 and GPS, Piper Drawing 104438-002, Cert. Basis - TSO C74C			
	a. Garmin GTX327 Transponder Unit 011-00490-10, Piper PS50040-12-12, Piper Code 651-938	2.90	59.24	171.79
	b. Garmin Connector/Rack Kit 011-00338-00, Piper PS50040-12-12, Piper Code 651-938	0.64	59.24	37.91
	c. Garmin Transponder Antenna 010-10160-00, Piper Code 683-724	0.21	55.11	11.57
	d. Harness, Backing plate, and Hardware, Piper Drawing 104438-002	1.10	52.90	58.04



THE NEW PIPER AIRCRAFT, INC

PA-28-181, ARCHER III
EQUIPMENT LIST
S/N 2843415 and UP

Item No.	Item	Weight (Pounds)	Arm (In.) Aft Datum	Moment (Lbs.-In.)
(h) Standard Avionics Equipment - continued				
177.	Garmin Audio Amp/Marker Installation, Piper Drawing 101193-003, Cert. Basis- TSO C35d and C50b			
	a. Garmin GMA 340 Audio Selector Panel, Piper PS50040-15-25, Piper Code 601-210			
	1. Garmin 011-00401-10 GMA Audio Panel Marker/Receiver	1.57	59.84	93.95
	2. Garmin 011-00403-00 Connector/Rack Kit	0.17	59.84	10.17
	b. Harnesses, Brackets and Hardware, Piper Drawing 101193-003	2.19	65.89	144.10
179.	Emergency Locator Transmitter Installation, Piper Drawing 06327-009, Cert. Basis TSO C91a			
	a. Artex ELT 110-4 Kit, Piper Code 599-515			
	1. Artex Transmitter 110-4 Unit/Bracket, Piper Code 599-515	4.26	236.75	1008.56
	2. Antenna Artex 110-324, Piper Code 599-515	0.09	208.88	18.80
	3. Coax Cable Artex 611-6013, Piper Code 599-515	0.14	222.82	31.20
	4. Remote Switch Artex 645-6196, Piper Code 599-515	0.07	62.44	4.37
	b. Harness and Hardware, Piper Drawing 06327-009	0.89	190.40	168.60
181.	Antennas			
	a. NAV Receiving AV12-PPR Antenna, Piper Code 451-802	0.40	264.9	105.96
	1. Nav Antenna Cable Assembly and Hardware, Piper Drawing 101311-002	0.862	169.431	146.02
	b. VHF Comm Comant CI-121 Antenna, Piper PS50040-18-2, Piper Code 596-664	0.543	158.500	85.99
	1. Comm Antenna Cable Assembly and Hardware, Piper Drawing 101311-002	0.802	99.892	80.11
	c. Comant CI-507 Antenna Coupler, Piper Code 557-704	0.163	54.938	8.95
	1. Antenna Coupler Hardware, Piper Drawing 101311-002	0.007	58.938	0.38
	d. Installation Hardware, Piper Drawing 101311-002	0.07	66.35	4.58
	e. GPS Antenna (Single) Installation, Piper Drawing 101273-2			
	1. Garmin 010-10040-01 Antenna Kit 683-721			
	a. Garmin 011-00134-00 GA56 Antenna, Piper Code 683-721	0.242	96.26	23.29
	b. Garmin 115-00031-00 Backing Plate, Piper Code 683-721	0.088	96.26	8.47
	2. Coax Cable, Piper Drawing 101265-005	0.523	77.98	40.78
183.	Marker Beacon Antenna Installation, Piper Drawing 39737-004			
	a. Marker Beacon Antenna Comant CI-102, Piper PS50040-15-10, Piper Code 597-893	0.45	217.17	98.60
	b. Marker Beacon Cable and Hardware, Piper Drawing 39737-004	1.08	122.559	132.50
185.	Avionics Cooling Blower Installation, Piper Drawing 101318-2			
	a. Troll Avionics Icebox FN-200 PSV 4000020 Blower, Piper Code 460-110	1.07	56.54	60.44
	b. Cable, Bracket and Hardware, Piper Drawing 101318-002	0.57	54.685	31.00



THE NEW PIPER AIRCRAFT, INC

PA-28-181, ARCHER III
EQUIPMENT LIST
S/N 2843415 and UP

Item No.	Item	Mark if Option Installed	Weight (Pounds)	Arm (In.) Aft Datum	Moment (Lbs.-In.)
(h) Standard Avionics Equipment - continued					
187.	Cabin Speaker Installation, Piper Drawing 84289-2				
	a. Speaker Assembly, Piper Drawing 85430-002				
	1. Speakers (2), Oaktron 4EU2742, Piper Code 487-192		1.33	88.18	117.01
	2. Harness and Hardware, Piper Drawing 85430-002		0.03	88.18	2.910
	b. Brackets and Hardware, Piper Drawing 84289-2		0.171	88.18	15.11
189.	Pilot's Microphone				
	a. Telex 100T/NH Microphone 62800-001, Piper Code 474-657		0.26	74.13	19.35
	b. Telex Holder 64022-000 and Hardware, Piper Drawing 79036-024		0.03	74.13	2.34
191.	Pilot's Headset				
	a. Telex 5161A Airman 760 Headset, Piper Code 692-205		0.20	80.5	16.34
193.	Pilot Mike Switch Assembly, Piper Drawing 101117-005		0.093	68.938	6.399
195.	CoPilot Mike Switch Assembly, Piper Drawing 101117-006		0.093	68.938	6.399
197.	Static wick installation Piper Drawing 69667-8				
	a.) Static Wicks (6)-Wing		0.2	136.3	27.3
	b.)Static Wicks (3)-Empennage		0.1	274.1	27.4

END OF STANDARD EQUIPMENT

(i) Optional Electrical Equipment

201.	Tail Light Assembly, Piper Drawing 63886-4	<input type="checkbox"/>	0.4	281.0	112.4
202.	Tail Strobe (Low Profile) Installation, Piper Drawing 104296-003				
	a. Strobe Light, Whelen 01-0790111-02, Piper Code 683-504	<input type="checkbox"/>	0.240	243.790	58.630
	b. Cables/Harnesses and Hardware, Piper Drawing 104296-003	<input type="checkbox"/>	1.29	195.03	251.26
	Tail Strobe Installation Total Weight		1.53	202.7	309.89



Item No.	Item	Mark if Option Installed	Weight (Pounds)	Arm (In.) Aft Datum	Moment (Lbs.-In.)
(j) Auto Pilots (Optional Equipment)					
203.	S-TEC System 55X Autopilot, Piper Drawing 104580-2				
a.	S-TEC Turn Coordinator 6405-28L, Piper Code 694-102	<input type="checkbox"/>	1.80	60.40	108.72
b.	Turn Coordinator Hardware, Piper Drawing 104580-002	<input type="checkbox"/>	0.01	62.99	0.89
c.	S-TEC Programmer /Computer 01192-1-48TP, Piper Code 651-921	<input type="checkbox"/>	2.70	58.20	157.14
d.	S-TEC Programmer Computer Bracket and Hardware Kit 901401-1 and Piper Drawing 104580-002	<input type="checkbox"/>	0.39	58.26	22.62
e.	S-TEC Transducer 0111, Piper Code 651-911	<input type="checkbox"/>	0.20	192.40	38.48
f.	S-TEC Transducer Installation Kit 90401-2, Piper Code 651-911	<input type="checkbox"/>	0.32	192.40	61.38
g.	Transducer Hardware, Piper Drawing 104580-002	<input type="checkbox"/>	0.10	191.00	18.81
h.	S-TEC Roll Servo 0106-R9, Piper Code 651-912	<input type="checkbox"/>	2.90	125.70	364.53
i.	S-TEC Roll Servo Brackets and Cable 90401-3	<input type="checkbox"/>	0.72	125.70	90.85
k.	Roll Servo Hardware, Piper Drawing 104580-002	<input type="checkbox"/>	0.09	122.23	11.04
l.	S-TEC Pitch Servo 0108-P4, Piper Code 651-913	<input type="checkbox"/>	2.90	120.90	350.61
m.	S-TEC Pitch Servo Bracket 60200	<input type="checkbox"/>	0.40	120.90	48.66
n.	Pitch Servo Hardware, Piper Drawing 104580-002	<input type="checkbox"/>	0.37	119.87	43.81
o.	S-TEC Trim Servo 0106-11-T6	<input type="checkbox"/>	2.90	113.90	330.31
p.	S-TEC Trim Servo Brackets and Hardware 90401-5	<input type="checkbox"/>	0.65	113.90	74.59
q.	Trim Servo Hardware, Piper Drawing 104580-2	<input type="checkbox"/>	0.07	111.49	7.29
r.	S-TEC Monitor/Sonalert, Sonalert 6542	<input type="checkbox"/>	0.10	57.50	5.75
u.	S-TEC Potentiometer Installation Kit 90401-6, Piper Code 651-951	<input type="checkbox"/>	0.11	123.78	14.17
v.	Potentiometer Hardware, Piper Drawing 104580-2	<input type="checkbox"/>	0.04	123.78	5.23
w.	S-TEC Switch Installation Kit 90401-7, Piper Code 651-916	<input type="checkbox"/>	0.07	63.04	4.11
x.	S-TEC Directional Gyro 6406-28L, Piper Code 694-103	<input type="checkbox"/>	3.40	59.00	200.60
y.	S-TEC Autopilot Cables 901401-009	<input type="checkbox"/>	4.737	80.97	383.53
z.	Installation Hardware, Piper Drawing 104580-002	<input type="checkbox"/>	0.33	61.20	19.94
	Removed Standard Directional Gyro, Piper PS50126-5		-2.40	59.7	-143.30
	Removed Standard Turn Coordinator, Piper PS50030-3-5		-1.20	59.7	-71.60
	S-TEC Autopilot Installation Weight (Delta)		22.23	97.99	2178.60



THE NEW PIPER AIRCRAFT, INC

PA-28-181, ARCHER III
EQUIPMENT LIST
S/N 2843415 and UP

Item No.	Item	Mark if Option Installed	Weight (Pounds)	Arm (In.) Aft Datum	Moment (Lbs.-In.)
(j) Auto Pilots (Optional Equipment) - continued					
205.	S-TEC Autopilot Installation with Heading System (HSI), Piper Drawing 104580-003				
a.	S-TEC System 55X Autopilot, Piper Drawing 104580-2 (Delta Weight)	<input type="checkbox"/>	22.23	97.99	2178.60
b.	S-TEC Autopilot Cable Weight 90401-10, Delta from standard	<input type="checkbox"/>	0.040	60.39	2.416
c.	Compass ST-180/ HSI Installation, Piper Drawing 101259-005				
1.	S-TEC 6443-PA Horizontal Situation Indicator	<input type="checkbox"/>	2.90	57.19	165.85
2.	S-TEC 6444 Remote Gyro	<input type="checkbox"/>	3.40	186.58	634.39
3.	S-TEC 01171-P Slaving Panel	<input type="checkbox"/>	0.10	60.94	6.09
4.	S-TEC 6446 Flux Sensor	<input type="checkbox"/>	0.30	104.06	31.22
5.	S-TEC 90480-1 Hardware Installation Kit	<input type="checkbox"/>	0.63	58.94	37.13
6.	Harnesses, Brackets and Hardware, Piper Drawing 101259-005	<input type="checkbox"/>	5.37	124.41	667.55
d.	Remove S-TEC Directional Gyro 6406-28L, Piper Code 694-103		-3.40	59.00	-200.60
	S-TEC Autopilot Installation with Heading System (HSI) Weight		31.58	111.573	3523.36
207.	S-TEC Autopilot Installation with Heading System (HSI) and Flight Director, Piper Drawing 104580-004				
a.	S-TEC System 55X Autopilot, Piper Drawing 104580 -2 (Delta Weight)	<input checked="" type="checkbox"/>	22.23	97.99	2178.60
b.	Switch Assembly with Post Light, Piper Drawing 101316-002	<input checked="" type="checkbox"/>	0.01	63.038	0.643
c.	S-TEC Autopilot Cable Weight 90401-11, Delta from standard	<input checked="" type="checkbox"/>	0.18	131.985	23.295
d.	S-TEC Flight Director Steering Horizon 6413-28L	<input checked="" type="checkbox"/>	3.00	58.20	174.6
e.	S-TEC Flight Director Annunciator 01188-1PX	<input checked="" type="checkbox"/>	0.539	58.20	31.37
f.	S-TEC Flight Director Placards and Trim Kit 901481-1	<input checked="" type="checkbox"/>	0.113	62.94	7.11
g.	Compass ST-180/ HSI Installation, Piper Drawing 101259-005				
1.	S-TEC 6443-PA Horizontal Situation Indicator	<input checked="" type="checkbox"/>	2.90	57.19	165.85
2.	S-TEC 6444 Remote Gyro	<input checked="" type="checkbox"/>	3.40	186.58	634.39
3.	S-TEC 01171-P Slaving Panel	<input checked="" type="checkbox"/>	0.10	60.94	6.09
4.	S-TEC 6446 Flux Sensor	<input checked="" type="checkbox"/>	0.30	104.06	31.22
5.	S-TEC 90480-1 Hardware Installation Kit	<input checked="" type="checkbox"/>	0.63	58.94	37.13
6.	Harnesses, Brackets and Hardware, Piper Drawing 101259-005	<input checked="" type="checkbox"/>	5.37	124.41	667.55
h.	Remove S-TEC Directional Gyro 6406-28L, Piper Code 694-103		-3.40	59.00	-200.60
i.	Removed Standard Attitude Gyro 99002-9, RCA 22-15		-2.80	59.90	-167.70
	S-TEC Autopilot Installation with Heading System (HSI) and Flight Director Weight		32.57	110.219	3589.55
209.	Altitude Selector/Alerter Installation, Piper Drawing 104580-005				
a.	S-TEC Altitude Selector/Alerter 0279-PX, Piper Code 652-158	<input checked="" type="checkbox"/>	0.90	61.20	55.08
b.	S-TEC Altitude Selector/Alerter Cable and Hardware 901482	<input checked="" type="checkbox"/>	0.34	62.87	21.12
	Altitude Selector/Alerter Installation Weight		1.24	61.65	76.20



Item No.	Item	Mark if Option Installed	Weight (Pounds)	Arm (In.) Aft Datum	Moment (Lbs.-In.)
(j) Auto Pilots (Optional Equipment)-continued					
211.	Pilot S-TEC Trim And Mike Switch Assembly 101117-15	<input type="checkbox"/>	0.21	68.94	14.59
	Removed Standard Pilot Mike Switch Assembly, Piper Drawing 101117-005	<input type="checkbox"/>	-0.093	68.938	-6.399
	Delta Weight		0.12	68.94	8.19
213.	Pilot S-TEC System 55 Autopilot Switch Assembly, Piper Drawing 101117-016	<input type="checkbox"/>	0.28	68.94	19.45
	Removed Standard Pilot Mike Switch Assembly, Piper Drawing 101117-005	<input type="checkbox"/>	-0.093	68.938	-6.399
	Delta Weight		0.19	68.94	13.05
215.	Avionics Cooling Blower - 3 Port Installation with Single GNS 430 and Autopilot, Piper Drawing 101318-2				
	a. Troll Avionics Icebox FN-200 PSV 4000020 Blower, Piper Code 460-110	<input type="checkbox"/>	1.07	56.54	60.44
	b. Cable, Bracket and Hardware, Piper Drawing 101318-2	<input type="checkbox"/>	0.78	54.57	42.45
	Removed Standard Avionics Cooling Blower Installation 101318-2		-1.64	55.90	-91.44
	Delta Weight		0.21	54.25	11.44
217.	Avionics Cooling Blower - 5 Port Installation with Dual GNS 430 and Autopilot, Piper Drawing 101318-4				
	a. Troll Avionics Icebox FN-400 PSV P/N 4000022-002 Blower, Piper Code 460-112	<input checked="" type="checkbox"/>	1.18	56.54	66.79
	b. Cable, Bracket and Hardware, Piper Drawing 101318-4	<input checked="" type="checkbox"/>	0.95	54.51	51.96
	Removed Standard Avionics Cooling Blower Installation 101318-2		-1.64	55.90	-91.44
	Delta Weight		0.50	54.77	27.31
(k) Optional Avionics Equipment					
221.	GNS 430 GPS/Nav/Com-(11-33 VDC) Single with Stormscope and Skywatch Provisions, Piper Drawing 104479-2				
	a. Garmin GNS430 #1 (11-33 VDC) with mount, connectors and data card, Piper PS50040-40-4, Piper Code 601-229	<input type="checkbox"/>	6.56	58.14	381.18
	b. Cables/harnesses and hardware, Piper Drawing 104479-2	<input type="checkbox"/>	2.00	55.58	111.22
	Removed Standard GNS 430 System Installation 104479-2		-8.48	57.53	-487.96
	Delta Weight		0.08	58.14	4.45
223.	GNS 430 GPS/Nav/Com - Single with Stormscope, Skywatch and Autopilot Provisions, Piper Drawing 104479-3				
	a. Garmin GNS430 #1 with mount, connectors and data card, Piper PS50040-40-1, Piper Code 601-214	<input type="checkbox"/>	6.48	58.14	376.73
	b. Cables/harnesses and hardware, Piper Drawing 104479-3	<input type="checkbox"/>	2.16	55.54	119.86
	Removed Standard GNS 430 System Installation 104479-2		-8.48	57.53	-487.96
	Delta Weight		0.16	55.10	8.63



Item No.	Item	Mark if Option Installed	Weight (Pounds)	Arm (In.) Aft Datum	Moment (Lbs.-In.)
(k) Optional Avionics Equipment-continued					
225.	GNS 430 GPS/Nav/Com (11-33 VDC) Single with Stormscope, Skywatch and Autopilot Provisions, Piper Drawing 104479-3				
	a. Garmin GNS430 #1 (11-33 VDC) with mount, connectors and data card, Piper PS50040-40-4, Piper Code 601-229	<input type="checkbox"/>	6.56	58.14	381.18
	b. Cables/harnesses and hardware, Piper Drawing 104479-3	<input type="checkbox"/>	2.16	55.54	119.86
	Removed Standard GNS 430 System Installation 104479-2		-8.48	57.53	-487.96
	Delta Weight		0.23	56.10	13.08
227.	GNS 430 GPS/Nav/Com - Single with Stormscope, Skywatch and DME Provisions, Piper Drawing 104479-4				
	a. Garmin GNS430 #1 with mount, connectors and data card, Piper PS50040-40-1, Piper Code 601-214	<input type="checkbox"/>	6.48	58.14	376.73
	b. Cables/harnesses and hardware, Piper Drawing 104479-4	<input type="checkbox"/>	2.16	55.54	119.86
	Removed Standard GNS 430 System Installation 104479-2		-8.48	57.53	-487.96
	Delta Weight		0.16	55.10	8.63
229.	GNS 430 GPS/Nav/Com (11-33 VDC) Single with Stormscope, Skywatch and DME Provisions, Piper Drawing 104479-4				
	a. Garmin GNS430 #1(11-33 VDC) with mount, connectors and data card, Piper PS50040-40-4, Piper Code 601-229	<input type="checkbox"/>	6.56	58.14	381.18
	b. Cables/harnesses and hardware, Piper Drawing 104479-4	<input type="checkbox"/>	2.16	55.54	119.86
	Removed Standard GNS 430 System Installation 104479-2		-8.48	57.53	-487.96
	Delta Weight		0.23	56.10	13.08
231.	GNS 430 GPS/Nav/Com - Single with Stormscope, Skywatch, Autopilot and DME Provisions, Piper Drawing 104479-5				
	a. Garmin GNS430 #1 with mount, connectors and data card, Piper PS50040-40-1, Piper Code 601-214	<input type="checkbox"/>	6.48	58.14	376.73
	b. Cables/harnesses and hardware, Piper Drawing 104479-5	<input type="checkbox"/>	2.27	55.52	125.92
	Removed Standard GNS 430 System Installation 104479-2		-8.48	57.53	-487.96
	Delta Weight		0.27	55.10	14.69
235.	GNS 430 GPS/Nav/Com (11-33 VDC) Single with Stormscope, Skywatch, Autopilot and DME Provisions, Piper Drawing 104479-5				
	a. Garmin GNS430 #1 (11-33 VDC) with mount, connectors and data card, Piper PS50040-40-4, Piper Code 601-229	<input type="checkbox"/>	6.56	58.138	381.18
	b. Cables/harnesses and hardware, Piper Drawing 104479-5	<input type="checkbox"/>	2.27	55.52	125.92
	Removed Standard GNS 430 System Installation 104479-2		-8.48	57.53	-487.96
	Delta Weight		0.34	55.778	19.14



Item No.	Item	Mark if Option Installed	Weight (Pounds)	Arm (In.) Aft Datum	Moment (Lbs.-In.)
(k) Optional Avionics Equipment-continued					
237.	GNS 430 GPS/Nav/Com - Single with Stormscope, Skywatch and HSI Provisions, Piper Drawing 104479-6				
	a. Garmin GNS430 #1 with mount, connectors and data card, Piper PS50040-40-1, Piper Code 601-214	<input type="checkbox"/>	6.48	58.14	376.73
	b. Cables/harnesses and hardware, Piper Drawing 104479-6	<input type="checkbox"/>	2.11	55.55	117.47
	Removed Standard GNS 430 System Installation 104479-2		-8.48	57.53	-487.96
	Delta Weight		0.11	55.10	6.24
239.	GNS 430 GPS/Nav/Com (11-33 VDC) Single with Stormscope, Skywatch and HSI Provisions, Piper Drawing 104479-6				
	a. Garmin GNS430 #1 (11-33 VDC) with mount, connectors and data card, Piper PS50040-40-4, Piper Code 601-229	<input type="checkbox"/>	6.56	58.138	381.18
	b. Cables/harnesses and hardware, Piper Drawing 104479-6	<input type="checkbox"/>	2.11	55.55	117.47
	Removed Standard GNS 430 System Installation 104479-2		-8.48	57.53	-487.96
	Delta Weight		0.19	56.325	10.69
241.	GNS 430 GPS/Nav/Com - Single with Stormscope, Skywatch, HSI and DME Provisions, Piper Drawing 104479-7				
	a. Garmin GNS430 #1 with mount, connectors and data card, Piper PS50040-40-1, Piper Code 601-214	<input type="checkbox"/>	6.48	58.14	376.73
	b. Cables/harnesses and hardware, Piper Drawing 104479-7	<input type="checkbox"/>	2.27	55.52	125.92
	Removed Standard GNS 430 System Installation 104479-2		-8.48	57.53	-487.96
	Delta Weight		0.27	55.10	14.69
243.	GNS 430 GPS/Nav/Com (11-33 VDC) Single with Stormscope, Skywatch, HSI and DME Provisions, Piper Drawing 104479-7				
	a. Garmin GNS430 #1 (11-33 VDC) with mount, connectors and data card, Piper PS50040-40-4, Piper Code 601-229	<input type="checkbox"/>	6.56	58.138	381.18
	b. Cables/harnesses and hardware, Piper Drawing 104479-7	<input type="checkbox"/>	2.27	55.52	125.92
	Removed Standard GNS 430 System Installation 104479-2		-8.48	57.53	-487.96
	Delta Weight		0.34	55.78	19.14
245.	GNS 430 GPS/Nav/Com - Dual With Stormscope and Skywatch Provisions, Piper Drawing 104480-2				
	a. Garmin GNS430 #1 with mount, connectors and data card, Piper PS50040-40-1, Piper Code 601-214	<input type="checkbox"/>	6.48	58.138	376.73
	b. Garmin GNS430 #2 with mount, connectors and data card, Piper PS50040-40-1, Piper Code 601-214	<input type="checkbox"/>	6.48	58.138	376.73
	c. Garmin GI-106 Indicator #2, Piper Code 602-239	<input type="checkbox"/>	1.02	60.23	61.43
	d. Cables/harnesses and hardware, Piper Drawing 104480-2	<input type="checkbox"/>	4.02	56.37	226.56
	Removed Standard GNS 430 System Installation 104479-2		-8.48	57.53	-487.96
	Delta Weight		9.52	18.57	176.77



Item No.	Item	Mark if Option Installed	Weight (Pounds)	Arm (In.) Aft Datum	Moment (Lbs.-In.)
(k) Optional Avionics Equipment - continued					
247.	GNS 430 GPS/Nav/Com (11-33 VDC) Dual With Stormscope and Skywatch Provisions, Piper Drawing 104480-2				
	a. Garmin GNS430 (11-33 VDC) #1 with mount, connectors and data card, Piper PS50040-40-4, Piper Code 601-229	<input type="checkbox"/>	6.56	58.138	381.18
	b. Garmin GNS430 (11-33 VDC) #2 with mount, connectors and data card, Piper PS50040-40-4, Piper Code 601-229	<input type="checkbox"/>	6.56	58.138	381.18
	c. Garmin GI-106 Indicator #2, Piper Code 602-239	<input type="checkbox"/>	1.02	60.23	61.43
	d. Cables/harnesses and hardware, Piper Drawing 104480-2	<input type="checkbox"/>	4.02	56.37	226.56
	Removed Standard GNS 430 System Installation 104479-2		-8.48	57.53	-487.96
	Delta Weight		9.67	58.15	562.40
249.	GNS 430 GPS/Nav/Com - Dual with Stormscope, Skywatch and Autopilot Provisions, Piper Drawing 104480-3				
	a. Garmin GNS430 #1 with mount, connectors and data card, Piper PS50040-40-1, Piper Code 601-214	<input type="checkbox"/>	6.48	58.138	376.73
	b. Garmin GNS430 #2 with mount, connectors and data card, Piper PS50040-40-1, Piper Code 601-214	<input type="checkbox"/>	6.48	58.138	376.73
	c. Garmin GI-106 Indicator #2, Piper Code 602-239	<input type="checkbox"/>	1.02	60.23	61.43
	d. Cables/harnesses and hardware, Piper Drawing 104480-3	<input type="checkbox"/>	4.25	56.297	239.506
	Removed Standard GNS 430 System Installation 104479-2		-8.48	57.534	-487.96
	Delta Weight		9.75	19.452	189.72
251.	GNS 430 GPS/Nav/Com (11-33 VDC) Dual with Stormscope, Skywatch and Autopilot Provisions, Piper Drawing 104480-3				
	a. Garmin GNS430 (11-33 VDC) #1 with mount, connectors and data card, Piper PS50040-40-4, Piper Code 601-229	<input type="checkbox"/>	6.56	58.138	381.18
	b. Garmin GNS430 (11-33 VDC) #2 with mount, connectors and data card, Piper PS50040-40-4, Piper Code 601-229	<input type="checkbox"/>	6.56	58.138	381.18
	c. Garmin GI-106 Indicator #2, Piper Code 602-239	<input type="checkbox"/>	1.02	60.23	61.43
	d. Cables/harnesses and hardware, Piper Drawing 104480-3	<input type="checkbox"/>	4.25	56.297	239.506
	Removed Standard GNS 430 System Installation 104479-2		-8.48	57.534	-487.96
	Delta Weight		9.91	58.080	575.34
253.	GNS 430 GPS/Nav/Com - Dual with Stormscope, Skywatch and DME Provisions, Piper Drawing 104480-4				
	a. Garmin GNS430 #1 with mount, connectors and data card, Piper PS50040-40-1, Piper Code 601-214	<input type="checkbox"/>	6.48	58.138	376.73
	b. Garmin GNS430 #2 with mount, connectors and data card, Piper PS50040-40-1, Piper Code 601-214	<input type="checkbox"/>	6.48	58.138	376.73
	c. Garmin GI-106 Indicator #2, Piper Code 602-239	<input type="checkbox"/>	1.02	60.23	61.43
	d. Cables/harnesses and hardware, Piper Drawing 104480-4	<input type="checkbox"/>	4.27	56.34	240.65
	Removed Standard GNS 430 System Installation 104479-2		-8.48	57.53	-487.96
	Delta Weight		9.77	19.53	190.86



Item No.	Item	Mark if Option Installed	Weight (Pounds)	Arm (In.) Aft Datum	Moment (Lbs.-In.)
(k) Optional Avionics Equipment - continued					
255.	GNS 430 GPS/Nav/Com (11-33 VDC) Dual with Stormscope, Skywatch and DME Provisions, Piper Drawing 104480-4				
	a. Garmin GNS430 (11-33 VDC) #1 with mount, connectors and data card, Piper PS50040-40-4, Piper Code 601-229	<input type="checkbox"/>	6.56	58.138	381.18
	b. Garmin GNS430 (11-33 VDC) #2 with mount, connectors and data card, Piper PS50040-40-4, Piper Code 601-229	<input type="checkbox"/>	6.56	58.138	381.18
	c. Garmin GI-106 Indicator #2, Piper Code 602-239	<input type="checkbox"/>	1.02	60.23	61.43
	d. Cables/harnesses and hardware, Piper Drawing 104480-4	<input type="checkbox"/>	4.27	56.34	240.65
	Removed Standard GNS 430 System Installation 104479-2		-8.48	57.53	-487.96
	Delta Weight		9.92	58.09	576.49
257.	GNS 430 GPS/Nav/Com - Dual with Stormscope, Skywatch, Autopilot and DME Provisions, Piper Drawing 104480-5				
	a. Garmin GNS430 #1 with mount, connectors and data card, Piper PS50040-40-1, Piper Code 601-214	<input type="checkbox"/>	6.48	58.138	376.73
	b. Garmin GNS430 #2 with mount, connectors and data card, Piper PS50040-40-1, Piper Code 601-214	<input type="checkbox"/>	6.48	58.138	376.73
	c. Garmin GI-106 Indicator #2, Piper Code 602-239	<input type="checkbox"/>	1.02	60.23	61.43
	d. Cables/harnesses and hardware, Piper Drawing 104480-5	<input type="checkbox"/>	4.38	56.30	246.58
	Removed Standard GNS 430 System Installation 104479-2		-8.48	57.53	-487.96
	Delta Weight		9.88	19.92	196.79
259.	GNS 430 GPS/Nav/Com (11-33 VDC) Dual with Stormscope, Skywatch, Autopilot and DME Provisions, Piper Drawing 104480-5				
	a. Garmin GNS430 (11-33 VDC) #1 with mount, connectors and data card, Piper PS50040-40-4, Piper Code 601-229	<input type="checkbox"/>	6.56	58.138	381.18
	b. Garmin GNS430 (11-33 VDC) #2 with mount, connectors and data card, Piper PS50040-40-4, Piper Code 601-229	<input type="checkbox"/>	6.56	58.138	381.18
	c. Garmin GI-106 Indicator #2, Piper Code 602-239	<input type="checkbox"/>	1.02	60.23	61.43
	d. Cables/harnesses and hardware, Piper Drawing 104480-5	<input type="checkbox"/>	4.38	56.30	246.58
	Removed Standard GNS 430 System Installation 104479-2		-8.48	57.53	-487.96
	Delta Weight		10.03	58.06	582.42
261.	GNS 430 GPS/Nav/Com, Dual with Stormscope, Skywatch and HSI Provisions, Piper Drawing 104480-6				
	a. Garmin GNS430 #1 with mount, connectors and data card, Piper PS50040-40-1, Piper Code 601-214	<input type="checkbox"/>	6.48	58.138	376.73
	b. Garmin GNS430 #2 with mount, connectors and data card, Piper PS50040-40-1, Piper Code 601-214	<input type="checkbox"/>	6.48	58.138	376.73
	c. Cables/harnesses and hardware, Piper Drawing 104480-6	<input type="checkbox"/>	4.17	56.32	234.96
	Removed Standard GNS 430 System Installation 104479-2		-8.48	57.53	-487.96
	Delta Weight		8.65	57.85	500.47



Item No.	Item	Mark if Option Installed	Weight (Pounds)	Arm (In.) Aft Datum	Moment (Lbs.-In.)
(k) Optional Avionics Equipment - continued					
263.	GNS 430 GPS/Nav/Com (11-33 VDC) Dual with Stormscope, Skywatch and HSI Provisions, Piper Drawing 104480-6				
	a. Garmin GNS430 (11-33 VDC) #1 with mount, connectors and data card, Piper PS50040-40-4, Piper Code 601-229	<input type="checkbox"/>	6.56	58.138	381.18
	b. Garmin GNS430 (11-33 VDC) #2 with mount, connectors and data card, Piper PS50040-40-4, Piper Code 601-229	<input type="checkbox"/>	6.56	58.138	381.18
	c. Cables/harnesses and hardware, Piper Drawing 104480-6	<input type="checkbox"/>	4.17	56.32	234.96
	Removed Standard GNS 430 System Installation 104479-2		-8.48	57.53	-487.96
	Delta Weight		8.80	57.86	509.37
265.	GNS 430 GPS/Nav/Com, Dual with Stormscope, Skywatch, HSI and DME Provisions, Piper Drawing 104480-7				
	a. Garmin GNS430 #1 with mount, connectors and data card, Piper PS50040-40-1, Piper Code 601-214	<input type="checkbox"/>	6.48	58.138	376.73
	b. Garmin GNS430 #2 with mount, connectors and data card, Piper PS50040-40-1, Piper Code 601-214	<input type="checkbox"/>	6.48	58.138	376.73
	c. Cables/harnesses and hardware, Piper Drawing 104480-7	<input type="checkbox"/>	4.38	56.30	246.58
	Removed Standard GNS 430 System Installation 104479-2		-8.48	57.53	-487.96
	Delta Weight		8.86	57.81	512.09
267.	GNS 430 GPS/Nav/Com (11-33 VDC) Dual with Stormscope, Skywatch, HSI and DME Provisions, Piper Drawing 104480-7				
	a. Garmin GNS430 (11-33 VDC) #1 with mount, connectors and data card, Piper PS50040-40-4, Piper Code 601-229	<input checked="" type="checkbox"/>	6.56	58.138	381.18
	b. Garmin GNS430 (11-33 VDC) #2 with mount, connectors and data card, Piper PS50040-40-4, Piper Code 601-229	<input checked="" type="checkbox"/>	6.56	58.138	381.18
	c. Cables/harnesses and hardware, Piper Drawing 104480-7	<input checked="" type="checkbox"/>	4.38	56.30	246.58
	Removed Standard GNS 430 System Installation 104479-2		-8.48	57.53	-487.96
	Delta Weight		9.01	57.82	520.98
269.	Garmin GTX-327 Transponder Installation with AR-850, and Dual GPS, Piper Drawing 104438-003				
	a. Garmin GTX327 Transponder Unit 011-00490-10, Piper PS50040-12-12, Piper Code 651-938	<input type="checkbox"/>	2.90	59.24	171.79
	b. Garmin Connector/Rack Kit 011-00338-00, Piper PS50040-12-12, Piper Code 651-938	<input type="checkbox"/>	0.64	59.24	37.91
	c. Garmin Transponder Antenna 010-10160-00, Piper Code 683-724	<input type="checkbox"/>	0.21	55.11	11.57
	d. Harness, Backing plate, and Hardware, Piper Drawing 104438-003	<input type="checkbox"/>	1.47	52.63	77.20
	Removed Standard GTX 327 System Installation, Piper Drawing 104438-002		-4.85	57.63	-279.31
	Delta Weight		0.37	51.80	19.17



Item No.	Item	Mark if Installed	Weight (Pounds)	Arm (In.) Aft Datum	Moment (Lbs.-In.)
(k) Optional Avionics Equipment - continued					
271.	Garmin GTX-327 Transponder Installation with AR-850, Dual GPS and Alt Preselect, Piper Drawing 104438-004				
	a. Garmin GTX327 Transponder Unit 011-00490-10, Piper PS50040-12-12, Piper Code 651-938	<input checked="" type="checkbox"/>	2.90	59.24	171.79
	b. Garmin Connector/Rack Kit 011-00338-00, Piper PS50040-12-12, Piper Code 651-938	<input checked="" type="checkbox"/>	0.64	59.24	37.91
	c. Garmin Transponder Antenna 010-10160-00, Piper Code 683-724	<input checked="" type="checkbox"/>	0.21	55.11	11.57
	d. Harness, Backing Plate, and Hardware, Piper Drawing 104438-004	<input checked="" type="checkbox"/>	1.36	52.69	71.50
	Removed Standard GTX 327 System Installation, Piper Drawing 104438-002		-4.85	57.63	-279.31
	Delta Weight		0.26	51.80	13.47
273.	Garmin GTX-327 Transponder Installation with AR-850, GPS and Skywatch Provisions, Piper Drawing 104438-005				
	a. Garmin GTX327 Transponder Unit 011-00490-10, Piper PS50040-12-12, Piper Code 651-938	<input type="checkbox"/>	2.90	59.24	171.79
	b. Garmin Connector/Rack Kit 011-00338-00, PS50040-12-12, Piper Code 651-938	<input type="checkbox"/>	0.64	59.24	37.91
	c. Garmin Transponder Antenna 010-10160-00, Piper Code 683-724	<input type="checkbox"/>	0.21	55.11	11.57
	d. Harness, Backing Plate, and Hardware, Piper Drawing 104438-004	<input type="checkbox"/>	1.35	52.70	70.99
	Removed Standard GTX 327 System Installation, Piper Drawing 104438-002		-4.85	57.63	-279.31
	Delta Weight		0.25	51.80	12.95
275.	Garmin GTX-327 Transponder Installation with AR-850, Dual GPS and Skywatch Provisions, Piper Drawing 104438-006				
	a. Garmin GTX327 Transponder Unit 011-00490-10, Piper PS50040-12-12, Piper Code 651-938	<input type="checkbox"/>	2.90	59.24	171.79
	b. Garmin Connector/Rack Kit 011-00338-00, Piper PS50040-12-12, Piper Code 651-938	<input type="checkbox"/>	0.64	59.24	37.91
	c. Garmin Transponder Antenna 010-10160-00, Piper Code 683-724	<input type="checkbox"/>	0.21	55.11	11.57
	d. Harness, Backing Plate, and Hardware, Piper Drawing 104438-006	<input type="checkbox"/>	1.35	52.70	70.99
	Removed Standard GTX 327 System Installation, Piper Drawing 104438-002		-4.85	57.63	-279.31
	Delta Weight		0.25	51.80	12.95



Item No.	Item	Mark if Option Installed	Weight (Pounds)	Arm (In.) Aft Datum	Moment (Lbs.-In.)
(k) Optional Avionics Equipment - continued					
277.	Garmin GTX-327 Transponder Installation with AR-850, Dual GPS, Skywatch and Alt. Preselect Provisions, Piper Drawing 104438-007				
a.	Garmin GTX327 Transponder Unit 011-00490-10, Piper PS50040-12-12, Piper Code 651-938	<input type="checkbox"/>	2.90	59.24	171.79
b.	Garmin Connector/Rack Kit 011-00338-00, Piper PS50040-12-12, Piper Code 651-938	<input type="checkbox"/>	0.64	59.24	37.91
c.	Garmin Transponder Antenna 010-10160-00, Piper Code 683-724	<input type="checkbox"/>	0.21	55.11	11.57
d.	Harness, Backing Plate, and Hardware, Piper Drawing 104438-007	<input type="checkbox"/>	1.48	52.62	77.72
	Removed Standard GTX 327 System Installation Piper Drawing 104438-002		-4.85	57.63	-279.31
	Delta Weight		0.38	51.80	19.69
279.	System Installation WX500 Stormscope, Piper Drawing 104484-002				
a.	WX-500 System (Stormscope), BF Goodrich 830-11500-001, Piper Code 601-225				
1.	WX-500 Stormscope Processor, BF Goodrich 805-11500-001, Piper Code 601-226	<input type="checkbox"/>	1.70	202.00	343.40
2.	WX-500 NY163 Stormscope Antenna, BF Goodrich 805-10930-001, Piper Code 683-728	<input type="checkbox"/>	0.81	206.00	165.83
3.	WX-500 Stormscope Antenna Cable, BF Goodrich 803-10950-004, Piper Code 653-688	<input type="checkbox"/>	0.39	193.74	74.59
4.	WX-500 Stormscope Installation Kit, BF Goodrich 817-11500-001, Piper Code 601-227	<input type="checkbox"/>	1.15	203.34	233.84
b.	Cable, Harness, Bracket and Hardware, Piper Drawing 104484-002	<input type="checkbox"/>	1.43	140.15	200.42
	WX500 Stormscope System Installation Total Weight		5.47	186.12	1018.08
281.	System Installation WX-500 Stormscope with Skywatch Provisions, Piper Drawing 104484-003				
a.	WX-500 System (Stormscope), BF Goodrich 830-11500-001, Piper Code 601-225				
1.	WX-500 Stormscope Processor, BF Goodrich 805-11500-001, Piper Code 601-226	<input type="checkbox"/>	1.70	202.00	343.40
2.	WX-500 NY163 Stormscope Antenna, BF Goodrich 805-10930-001, Piper Code 683-728	<input type="checkbox"/>	0.81	206.00	165.83
3.	WX-500 Stormscope Antenna Cable, BF Goodrich 803-10950-004, Piper Code 653-688	<input type="checkbox"/>	0.39	193.74	74.59
4.	WX-500 Stormscope Installation Kit, BF Goodrich 817-11500-001, Piper Code 601-227	<input type="checkbox"/>	1.15	203.34	233.84
b.	Cable, Harness, Bracket and Hardware, Piper Drawing 104484-003	<input type="checkbox"/>	1.52	139.67	212.28
	WX500 Stormscope System with Skywatch Provisions Installation Total Weight		5.56	185.25	1029.95



Item No.	Item	Mark if Option Installed	Weight (Pounds)	Arm (In.) Aft Datum	Moment (Lbs.-In.)
(k) Optional Avionics Equipment - continued					
283.	System Installation WX-500 Stormscope without Heading system, Piper Drawing 104484-004				
a.	WX-500 System (Stormscope), BF Goodrich 830-11500-001, Piper Code 601-225				
1.	WX-500 Stormscope Processor, BF Goodrich 805-11500-001, Piper Code 601-226	<input type="checkbox"/>	1.70	202.00	343.40
2.	WX-500 NY163 Stormscope Antenna, BF Goodrich 805-10930-001, Piper Code 683-728	<input type="checkbox"/>	0.81	206.00	165.83
3.	WX-500 Stormscope Antenna Cable, BF Goodrich 803-10950-004, Piper Code 653-688	<input type="checkbox"/>	0.39	193.74	74.59
4.	WX-500 Stormscope Installation Kit, BF Goodrich 817-11500-001, Piper Code 601-227	<input type="checkbox"/>	1.15	203.34	233.84
b.	Cable, Harness, Bracket and Hardware, Piper Drawing 104484-004	<input type="checkbox"/>	1.52	139.66	212.29
	WX500 Stormscope System without Heading System Installation Total Weight		5.56	185.24	1029.96
285.	System Installation SKY 497 Skywatch, Piper Drawing 104486-002				
a.	SKY 497 System (Skywatch), Piper Drawing 72496-280				
1.	TRC-497 Transmitter/Receiver Computer (Skywatch), BF Goodrich 805-10800-001 with Mounting Tray Assembly 805-10870-001, Piper Code 601-223	<input type="checkbox"/>	9.86	183.88	1813.09
2.	TRC-497 Installation Kit, BF Goodrich 817-10800-003, Piper Code 601-224	<input type="checkbox"/>	0.51	183.88	93.78
3.	TRC-497 NY164 Directional Antenna, BF Goodrich 805-10890-001, Piper Code 683-726	<input type="checkbox"/>	2.31	116.50	269.12
4.	TRC-497 NY164 Directional Antenna Installation Kit, BF Goodrich 817-10009-006, Piper Code 683-727	<input type="checkbox"/>	0.76	116.50	87.96
b.)	Cable, Harness, Bracket and Hardware, Piper Drawing 104486-002	<input type="checkbox"/>	4.68	130.81	611.80
	TRC-497 Skywatch System Installation Total Weight		18.11	158.77	2875.74
287.	System Installation SKY 497 Skywatch with WX-500 Stormscope Provisions, Piper Drawing 104486-003				
a.	SKY 497 System (Skywatch), Piper Drawing 72496-280				
1.	TRC-497 Transmitter/Receiver Computer (Skywatch), BF Goodrich 805-10800-001 with Mounting Tray Assembly 805-10870-001, Piper Code 601-223	<input type="checkbox"/>	9.86	183.88	1813.09
2.	TRC 497 Installation Kit, BF Goodrich 817-10800-003, Piper Code 601-224	<input type="checkbox"/>	0.51	183.88	93.78
3.	TRC-497 NY164 Directional Antenna, BF Goodrich 805-10890-001, Piper Code 683-726	<input type="checkbox"/>	2.31	116.50	269.12
4.	TRC-497 NY164 Directional Antenna Installation Kit, BF Goodrich 817-10009-006, Piper Code 683-727	<input type="checkbox"/>	0.76	116.50	87.96
b.	Cable, Harness, Bracket and Hardware, Piper Drawing 104486-003	<input type="checkbox"/>	4.78	130.60	623.89
	TRC-497 Skywatch System with WX-500 Stormscope Provisions Installation Total Weight		18.21	158.57	2887.83



Item No.	Item	Mark if Option Installed	Weight (Pounds)	Arm (In.) Aft Datum	Moment (Lbs.-In.)
(k) Optional Avionics Equipment - continued					
289.	System Installation SKY 497 Skywatch without Heading system, Piper Drawing 104486-004				
a.	SKY -497 System (Skywatch), Piper Drawing 72496-280				
1.	TRC-497 Transmitter/Receiver Computer (Skywatch), BF Goodrich 805-10800-001 with Mounting Tray Assembly 805-10870-001, Piper Code Number 601-223	<input type="checkbox"/>	9.86	183.88	1813.09
2.	TRC-497 Installation Kit, BF Goodrich 817-10800-003, Piper Code 601-224	<input type="checkbox"/>	0.51	183.88	93.78
3.	TRC-497 NY164 Directional Antenna, BF Goodrich 805-10890-001, Piper Code 683-726	<input type="checkbox"/>	2.31	116.50	269.12
4.	TRC-497 NY164 Directional Antenna Installation Kit, BF Goodrich 817-10009-006, Piper Code 683-727	<input type="checkbox"/>	0.76	116.50	87.96
b.	Cable, Harness, Bracket and Hardware, Piper Drawing 104486-004	<input type="checkbox"/>	4.59	131.00	600.92
	TRC-497 Skywatch System Installation without Heading System Total Weight		18.02	158.96	2864.86
291.	Shelf Installation (Required with DME and WX-500 Stormscope options), Piper Drawing 99466-026				
a.	Shelf assembly Piper Drawing 101253-004	<input checked="" type="checkbox"/>	1.10	201.60	220.85
293.	S-TEC Manual Electric Trim Installation, Piper Drawing 100831-2				
a.	S-TEC Trim Servo 0106-11-T6	<input type="checkbox"/>	2.90	113.90	330.31
b.	S-TEC Monitor/Sonalert Trim Monitor 01240	<input type="checkbox"/>	0.30	57.50	17.25
c.	S-TEC Monitor/Sonalert, Sonalert 6551	<input type="checkbox"/>	0.10	58.18	5.82
d.	S-TEC Trim Servo Installation Kit-Hardware 90402-1	<input type="checkbox"/>	0.58	113.54	66.27
e.	S-TEC Trim Switch and Cable Installation Kit 90402-2	<input type="checkbox"/>	0.80	82.71	66.07
f.	S-TEC Monitor/Sonalert Installation Kit Hardware 90402-3	<input type="checkbox"/>	0.17	58.04	9.90
g.	Harnesses, Brackets and Hardware, Piper Drawing 100831-2	<input type="checkbox"/>	0.54	72.97	39.38
h.	Pilot S-TEC Trim And Mike Switch Assembly, Piper Drawing 101117-015	<input type="checkbox"/>	0.21	68.94	14.59
	Removed Pilot Mike Switch Assembly, Piper Drawing 101117-005		-0.09	68.94	-6.399
	Delta Weight		5.51	98.56	543.19
295.	Audio Amp/Marker Installation with Autopilot, Piper Drawing 101193-2				
a.	Garmin GMA 340 Audio Selector Panel, Piper PS50040-15-25, Piper Code 601-210				
1.	Garmin 011-00401-10 GMA Audio Panel Marker/Receiver	<input checked="" type="checkbox"/>	1.57	59.838	93.95
2.	Garmin 011-00403-00 Connector/Rack Kit	<input checked="" type="checkbox"/>	0.17	59.838	10.17
b.	Harnesses, Brackets and Hardware, Piper Drawing 101193-2	<input checked="" type="checkbox"/>	2.18	65.901	143.97
	Removed Standard Audio/Amp System Installation, Piper Drawing 101193-3		-3.93	63.210	-248.22
	Delta Weight		0.00	57.24	-0.13



Item No.	Item	Mark if Option Installed	Weight (Pounds)	Arm (In.) Aft Datum	Moment (Lbs.-In.)
(k) Optional Avionics Equipment - continued					
297.	S-TEC ADF RCR-650A Installation, Piper Drawing 101195-2				
a.	S-TEC ADF Kit (RCR-650A), Piper PS50040-31-27, Piper Code 601-213				
1.	S-TEC Receiver RCR-650A 690108-P	<input checked="" type="checkbox"/>	2.44	58.04	141.61
2.	S-TEC Receiver Installation Kit 690212	<input checked="" type="checkbox"/>	0.55	61.24	33.68
3.	S-TEC Indicator IND-650A 690113-P	<input checked="" type="checkbox"/>	0.66	61.24	40.42
4.	S-TEC Indicator Installation Kit 690217	<input checked="" type="checkbox"/>	0.18	61.24	11.02
5.	S-TEC Antenna ANT-650A 690124	<input checked="" type="checkbox"/>	2.3	162.8	371.1
6.	S-TEC Antenna Installation Kit 690215	<input checked="" type="checkbox"/>	0.0	161.8	3.2
7.	S-TEC Power Adapter 01255	<input checked="" type="checkbox"/>	0.52	164.50	85.54
b.	Harness, Bracket and Hardware, Piper Drawing 101195-2	<input checked="" type="checkbox"/>	3.22	89.90	289.83
	S-TEC ADF RCR-650A Installation Total Weight		9.87	98.89	976.43
299.	S-TEC ADF RCR 650D Installation, Piper Drawing 101195-3				
a.	S-TEC ADF Kit (RCR 650D), Piper PS50040-31-27, Piper Code 652-168				
1.	S-TEC Receiver RCR 650D, p/n 690108-4	<input type="checkbox"/>	2.484	58.04	144.17
2.	S-TEC Receiver Installation Kit, p/n 690212	<input type="checkbox"/>	0.55	61.238	33.6809
3.	S-TEC Indicator IND 650D, p/n 690113-P	<input type="checkbox"/>	0.66	61.238	40.4171
4.	S-TEC Indicator Installation Kit, p/n 690217	<input type="checkbox"/>	0.18	61.238	11.0228
5.	S-TEC Antenna ANT 650D, p/n 690124	<input type="checkbox"/>	2.28	162.76	371.093
6.	S-TEC Antenna Installation Kit, p/n 690215	<input type="checkbox"/>	0.02	161.78	3.2356
7.	S-TEC Power Adapter, p/n 01255	<input type="checkbox"/>	0.52	164.5	85.54
b.	Harness, Bracket and Hardware, Piper Drawing 101195-3	<input type="checkbox"/>	3.22	89.894	289.76
	S-TEC ADF RCR 650D Installation Total Weight		9.917	98.71	978.914
301.	S-TEC DME 451 with /450 Indicator Installation, Piper Drawing 101245-3				
a.	S-TEC DME Installation Kit, Piper PS50040-31-26, Piper Code 601-212				
1.)	S-TEC Transceiver TCR-451 690109	<input checked="" type="checkbox"/>	2.71	57.19	154.98
2.)	S-TEC Transceiver Installation Kit 690224	<input checked="" type="checkbox"/>	3.38	186.58	630.65
3.)	S-TEC Indicator IND-450 690111-P	<input checked="" type="checkbox"/>	0.10	60.94	6.09
4.)	S-TEC Indicator Installation Kit 690221	<input checked="" type="checkbox"/>	0.38	104.059	39.54242
5.)	S-TEC Antenna ANT-451 690126	<input checked="" type="checkbox"/>	0.08	62.94	5.04
6.)	S-TEC Antenna Installation Kit 690218	<input checked="" type="checkbox"/>	0.63	58.94	37.13
b.)	Harness and Hardware, Piper Drawing 101245-3	<input checked="" type="checkbox"/>	5.37	124.41	667.55
	S-TEC DME 451 with /450 Indicator Installation Total Weight		12.65	121.86	1540.99
303.	Antenna Installation - Dual GPS and Com, Piper Drawing 101311-003				
a.	NAV Receiving AV12-PPR Antenna, Piper Code 451-802	<input checked="" type="checkbox"/>	0.40	264.9	105.96
1.	Nav Antenna Cable Assembly and Hardware, Piper Drawing 101311-003	<input checked="" type="checkbox"/>	0.862	169.431	146.025
b.	VHF Comm Comant CI-121 Antenna, Piper PS50040-18-2, Piper Code 596-664	<input checked="" type="checkbox"/>	0.543	158.500	85.986



Item No.	Item	Mark if Option Installed	Weight (Pounds)	Arm (In.) Aft Datum	Moment (Lbs.-In.)
(k) Optional Avionics Equipment - continued					
303.	Antenna Installation - Dual GPS and Com, Piper Drawing 101311-003 - continued				
	1. Comm #1 Antenna Cable Assembly and Hardware, Piper Drawing 101311-003	<input checked="" type="checkbox"/>	0.802	99.892	80.114
	c. Comant CI-1125 Antenna Coupler, Piper Code 556-753	<input checked="" type="checkbox"/>	0.191	54.938	10.466
	1. Antenna Coupler Hardware, Piper Drawing 101311-003	<input checked="" type="checkbox"/>	0.007	58.938	0.383
	d. VHF Comm Antenna #2 Comant CI-122, Piper Code 683-725	<input checked="" type="checkbox"/>	0.60	123.355	74.1
	1. Comm #2 Antenna Cable Assembly and Hardware, Piper Drawing 101311-003	<input checked="" type="checkbox"/>	0.831	83.960	69.8
	e. Installation Hardware, Piper Drawing 101311-003	<input checked="" type="checkbox"/>	0.07	66.35	4.584
	f. GPS Antenna (Dual) Installation, Piper Drawing 101273-3				
	1. 010-10040-01 Antenna Kit #2 683-721				
	a. Garmin 011-00134-00 GA56 Antenna #2, Piper Code 683-721	<input checked="" type="checkbox"/>	0.24	96.26	23.29
	b. Garmin 115-00031-00 Backing plate #2, Piper Code 683-721	<input checked="" type="checkbox"/>	0.09	96.26	8.47
	2. Coax Cable #2, Piper Drawing 101266-004	<input checked="" type="checkbox"/>	0.50	77.98	38.99
	Removed Standard Antenna Installation - Single Com, Piper Drawing 101311-002		-2.84	151.85	-432.01
	Delta Weight		2.29	94.42	216.17
305.	Avionics Cooling Blower - 3 Port Installation With Dual GNS 430 and Without Autopilot, Piper Drawing 101318-2				
	a. Troll Avionics Icebox FN-200 PSV 4000020 Blower, Piper Code 460-110	<input type="checkbox"/>	1.07	56.54	60.44
	b. Cable, Bracket and Hardware, Piper Drawing 101318-2	<input type="checkbox"/>	0.78	54.57	42.45
	Removed Standard Avionics Cooling Blower Installation 101318-2		-1.64	55.90	-91.44
	Delta Weight		0.21	54.25	11.44
307.	DC-AC Inverter Installation (Required with SKY-497 Skywatch and HSI and/or WX-500 Stormscope and HSI options) Piper Drawing 104490-002				
	a. DC-AC Inverter MD26-28, Piper Code 602-248	<input type="checkbox"/>	0.471	160.167	75.358
	b. Cable, Harness, Bracket and Hardware, Piper Drawing 104490-002	<input type="checkbox"/>	0.36	113.08	40.94
	DC-AC Inverter Installation Total Weight		0.83	139.69	116.30
309.	Pilot's Boom Mike Headset (Telex Airman 750) replaces standard Pilot's Headset 5161A Telex Airman 760				
	a. Pilot's Headset, Telex Airman 750, Piper Code 464-448	<input type="checkbox"/>	0.26	80.5	20.89
	b. Removed Standard Pilot's Headset Telex 5161A Airman 760 Headset, Piper Code 692-205		-0.20	80.5	-16.34
	Delta Weight		0.06	80.500	4.55



THE NEW PIPER AIRCRAFT, INC

PA-28-181, ARCHER III
EQUIPMENT LIST
S/N 2843415 and UP

Item No.	Item	Mark if Option Installed	Weight (Pounds)	Arm (In.) Aft Datum	Moment (Lbs.-In.)
(l) Optional Instrumentation Equipment					
321.	Dual Altimeter Installation, Piper Drawing 85518-2 (Altimeter Piper PS50008-10-2D) Cert. Basis - TSO C10b	<input checked="" type="checkbox"/>	1.2	60.9	73.1
323.	Carburetor Ice Detector, Piper Drawing 85519-2	<input checked="" type="checkbox"/>	0.5	62.1	31.1
325.	Compass ST-180/HSI Installation without Autopilot Installation, Piper Drawing 101259-004				
	a. S-TEC 6443-PA Horizontal Situation Indicator	<input type="checkbox"/>	2.900	57.19	165.85
	b. S-TEC 6444 Remote Gyro	<input type="checkbox"/>	3.400	186.58	634.39
	c. S-TEC 01171-P Slaving Panel	<input type="checkbox"/>	0.100	60.94	6.09
	d. S-TEC 6446 Flux Sensor	<input type="checkbox"/>	0.300	104.06	31.22
	e. S-TEC 90480-1 Hardware Installation Kit	<input type="checkbox"/>	0.630	58.94	37.13
	f. Harnesses, Brackets and Hardware, Piper Drawing 101259-004	<input type="checkbox"/>	5.37	124.41	667.55
	Compass ST-180/HSI Installation without Autopilot Installation Total Weight		12.70	121.477	1542.23
327.	Turn and Slip Indicator, Piper PS50030-2-4, replaces the standard Turn Coordinator, Piper PS50030-3-5				
	Turn and Slip Indicator, Piper PS50030-2-4	<input type="checkbox"/>	1.2	59.7	71.6
	Removed Turn Coordinator, Piper PS50030-3-5, Cert. Basis TSO C3b		-1.2	59.7	-71.6
	Delta Weight		0.0	59.7	0.0
(m) Cabin Interior (Optional)					
351.	All Leather Pilot Adjustable Seat with Headrest (lumbar support) replaces Standard Pilot Adjustable Seat with Cloth				
	Pilot Adjustable Seat (leather) with Headrest and Lumbar Support, Piper Drawing 89026-2	<input checked="" type="checkbox"/>	24.96	83.00	2071.68
	Replace Pilot Adjustable Seat (cloth) with Headrest and Lumbar Support, Piper Drawing 89026-2		-24.46	83.00	-2030.18
	Delta Weight		0.50	83.00	41.50



Item No.	Item	Mark if Option Installed	Weight (Pounds)	Arm (In.) Aft Datum	Moment (Lbs.-In.)
(m) Cabin Interior (Optional) - continued					
353.	All Leather CoPilot Adjustable Seat with Headrest (lumbar support) replaces Standard CoPilot Adjustable Seat with Cloth CoPilot Adjustable Seat (leather) with Headrest and Lumbar Support, Piper Drawing 89026-3	<input checked="" type="checkbox"/>	24.96	82.80	2066.69
	Replace CoPilot Adjustable Seat (cloth) with Headrest and Lumbar Support, Piper Drawing 89026-3		-24.46	82.80	-2025.29
	Delta Weight		0.50	82.80	41.40
355.	All Leather Aft Right Seat with Headrest replaces Standard Aft Right Seat with Cloth Aft Rear Seat (leather) (right) with Headrest, Piper Drawing 89027-3	<input checked="" type="checkbox"/>	16.19	123.00	1991.37
	Replace Aft Rear Seat (cloth) (right) with Headrest, Piper Drawing 89027-3		-15.79	123.00	-1942.17
	Delta Weight		0.40	123.00	49.20
357.	All Leather Aft Left Seat with Headrest replaces Standard Aft Left Seat with Cloth Aft Rear Seat (leather) (left) with Headrest, Piper Drawing 89027-2	<input checked="" type="checkbox"/>	16.19	123.00	1991.37
	Replace Aft Rear Seat (cloth) (left) with Headrest, Piper Drawing 89027-2		-15.79	123.00	-1942.17
	Delta Weight		0.40	123.00	49.20
(n) Miscellaneous Optional Equipment					
371.	Air Conditioning Installation, HFC 134A, Piper Drawing 99575-11				
	a. Condenser Installation (Piper Drawing 99855-4)	<input type="checkbox"/>	11.91	179.69	2140.7
	b. Condenser-Heathcraft 979495 (Piper Code 552-250)	<input type="checkbox"/>	4.60	179.94	827.7
	c. Condenser Frame Assembly (Piper Drawing 99549-19)	<input type="checkbox"/>	3.34	182.15	608.4
	d. Refrigerant Lines Installation (Piper Drawing 99576-7)	<input type="checkbox"/>	12.57	70.26	883.47
	e. Electrical Installation (Piper Drawing 99979-9)	<input type="checkbox"/>	3.34	118.23	394.862
	f. Compressor Installation (Piper Drawing 99109-12)	<input type="checkbox"/>	3.23	11.86	38.31
	g. Air Conditioning Compressor Assembly Compressor, York EF209-25019, HFC134A with Pitts 14214 Clutch	<input type="checkbox"/>	21.83	13.61	297.15
	h. Bulkhead Installation (Piper Drawing 78734-10) Evaporator Installation Items	<input type="checkbox"/>	3.87	172.79	668.80
	i. Evaporator-Heathcraft C-6177 (Piper Code 552-201)	<input type="checkbox"/>	3.77	160.60	604.67
	j. Blower Assembly, Piper Drawing 99642-4	<input type="checkbox"/>	3.90	174.72	681.42
	k. Receiver-Dehydrator-AMA 37781 (Piper Code 602-275)	<input type="checkbox"/>	1.36	168.01	228.49
	l. Removed Standard Fresh Air Blower Installation, Piper Drawing 36983-17, Aft		-8.71	186.44	-1624.8
	M. Removed Standard Cable Assembly, Piper Drawing 89402-2		-1.88	165.50	-310.48
	Delta Weight		63.13	165.15	5438.70



THE NEW PIPER AIRCRAFT, INC

PA-28-181, ARCHER III
EQUIPMENT LIST
S/N 2843415 and UP

Item No.	Item	Mark if Option Installed	Weight (Pounds)	Arm (In.) Aft Datum	Moment (Lbs.-In.)
----------	------	--------------------------	-----------------	---------------------	-------------------

(n) Miscellaneous Optional Equipment

373.	Low Noise Exhaust Resonator Assembly replaces Standard Tail Pipe Assembly	<input type="checkbox"/>	4.34	33.23	144.22
	Low Noise Muffler Assembly, Piper Drawing 85577-2		-1.60	33.23	-53.17
	Standard Tail Pipe Assembly, Piper Drawing 85477-2		2.74	33.23	91.05
	Delta Weight				

END FACTORY INSTALLED OPTIONS

TOTAL OPTIONAL EQUIPMENT	<u>73.0</u>	<u>102.2918</u>	<u>7467.3</u>
---------------------------------	--------------------	------------------------	----------------------

END OF ORIGINAL EQUIPMENT INSTALLATION

TABLE OF CONTENTS
SECTION 7
DESCRIPTION AND OPERATION
OF THE AIRPLANE AND ITS SYSTEMS

Paragraph No.		Page No.
7.1	The Airplane.....	7-1
7.3	Airframe	7-1
7.5	Engine and Propeller	7-1
7.7	Landing Gear	7-3
7.9	Flight Controls.....	7-5
7.11	Engine Controls.....	7-7
7.13	Fuel System	7-7
7.15	Electrical System.....	7-9
7.17	Vacuum System	7-12
7.19	Instrument Panel.....	7-13
7.21	Pitot-Static System	7-18
7.23	Heating and Ventilating System	7-21
7.25	Cabin Features.....	7-21
7.27	Baggage Area	7-22
7.29	Stall Warning	7-22
7.31	Finish.....	7-23
7.33	Air Conditioning	7-23
7.35	External Power	7-24
7.37	Emergency Locator Transmitter	7-25
7.39	Carburetor Ice Detection System	7-27

THIS PAGE INTENTIONALLY LEFT BLANK

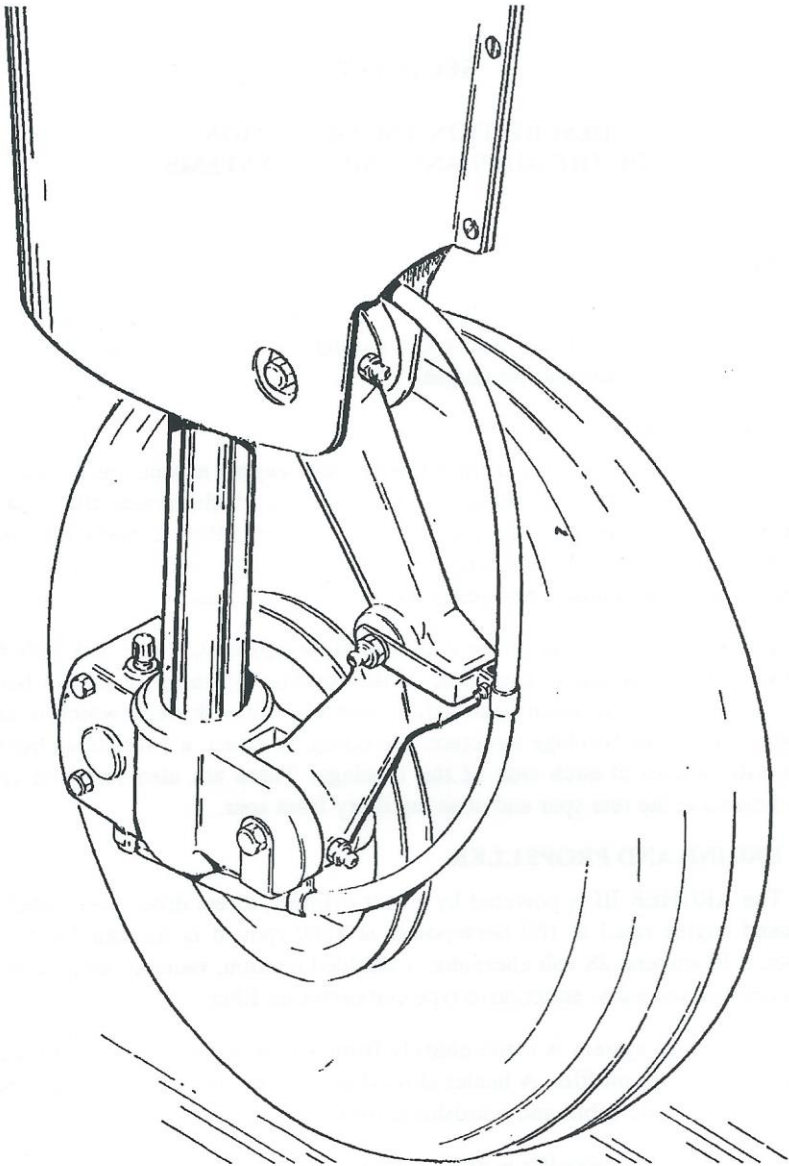

MAIN WHEEL ASSEMBLY

Figure 7-1

(Wheel fairing removed for clarity.)

7.7 LANDING GEAR

The three landing gears use Cleveland 6.00 x 6 wheels, the main gear wheels (Figure 7-1) being provided with brake drums and Cleveland single disc hydraulic brake assemblies. All three wheels use 6.00 x 6, four-ply rating, Type III tires with tubes.

A spring device is incorporated in the rudder pedal torque tube assembly to provide rudder trim. A bungee in the nose gear steering mechanism reduces steering effort and dampens bumps and shocks during taxiing. By using the rudder pedals and brakes the nose gear is steerable through a 30 degree arc each side of center. Later aircraft have the bungee removed from the nose gear steering mechanism and are steerable through a 20 degree arc each side of center. A shimmy dampener is also included in the nose gear.

The three struts are of the air-oil type, with a normal extension of 3.25 inches for the nose gear and 4.50 inches for the main gear.

The standard brake system consists of dual toe brakes attached to the rudder pedals and a hand lever and master cylinder located below and behind the left center of the instrument sub-panel. The toe brakes and the hand brake have their own brake cylinders, but they share a common reservoir. The brake fluid reservoir is installed on the top left front face of the fire wall. The parking brake is incorporated in the master cylinder and is actuated by pulling back on the brake lever, depressing the knob attached to the left side of the handle, and releasing the brake lever. To release the parking brake, pull back on the brake lever to disengage the catch mechanism and allow the handle to swing forward (refer to Figure 7-5).

THIS PAGE INTENTIONALLY LEFT BLANK

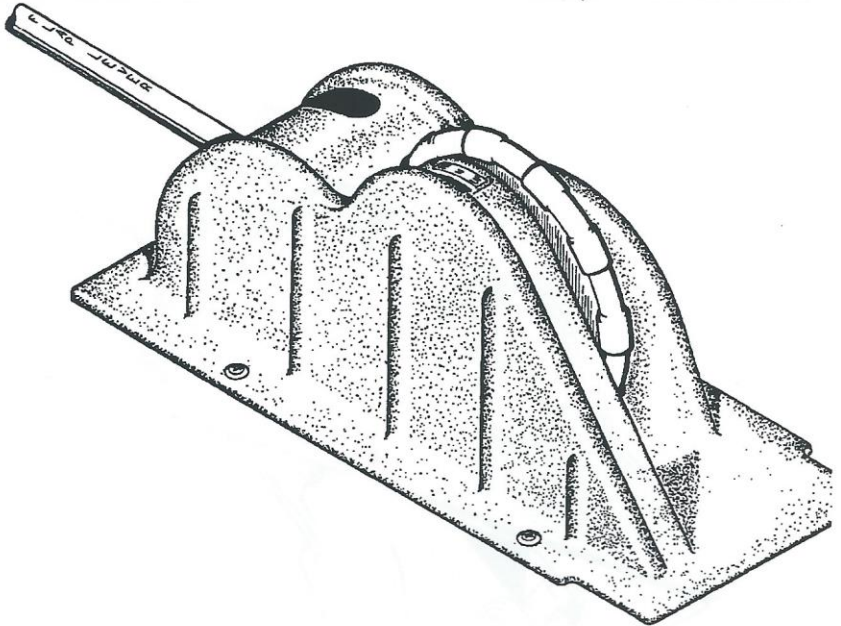

FLIGHT CONTROL CONSOLE

Figure 7-3

7.9 FLIGHT CONTROLS

Dual controls are provided as standard equipment, with a cable system used between the controls and the surfaces. The horizontal tail (stabilator) is of the all-movable slab type with a trim tab mounted on the trailing edge of the stabilator to reduce the control system forces. This tab is actuated by a control wheel on the floor between the front seats (Figure 7-3).

A rudder trim adjustment is mounted on the right side of the pedestal below the throttle quadrant and permits directional trim as needed in flight (refer to Figure 7-5).

The flaps are manually operated and spring-loaded to return to the up position. A past-center lock incorporated in the actuating linkage holds the flap when it is in the up position so that it may be used as a step on the right side. The flap will not support a step load except when in the full up position, so it must be completely retracted when used as a step. The flaps have three extended positions, 10, 25 and 40 degrees.

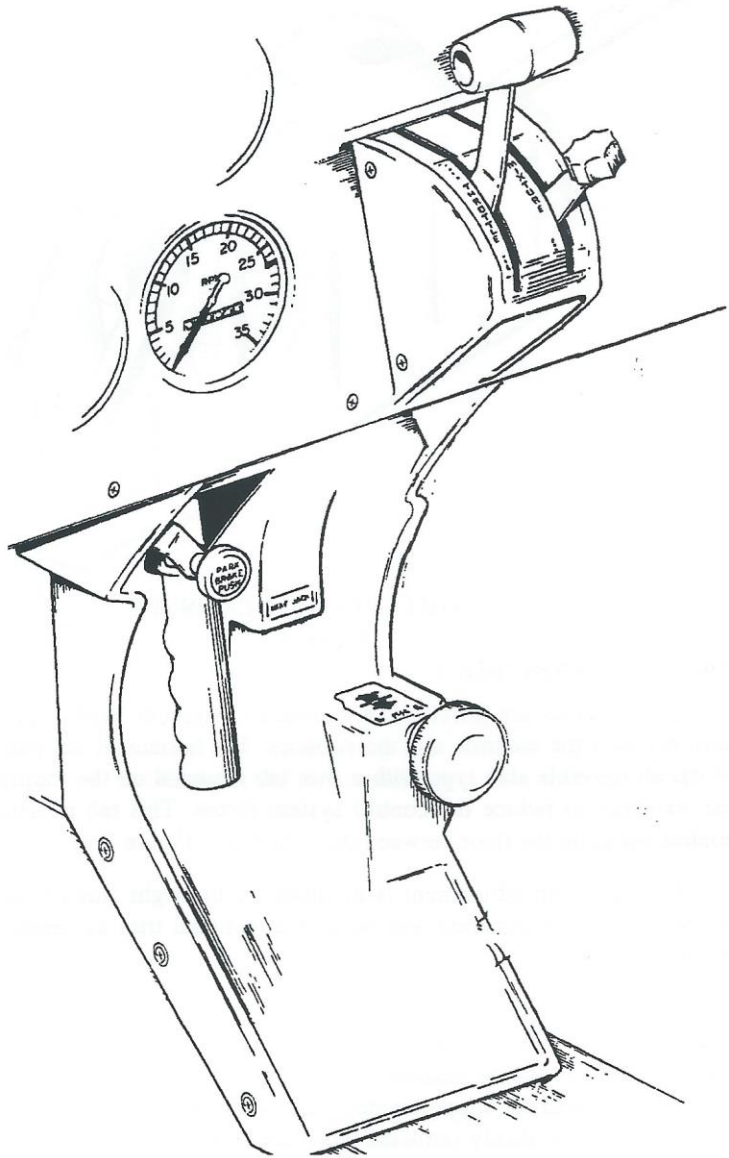

CONTROL QUADRANT AND CONSOLE

Figure 7-5

7.11 ENGINE CONTROLS

Engine controls consist of a throttle control and a mixture control lever. These controls are located on the control quadrant on the lower center of the instrument panel (Figure 7-5) where they are accessible to both the pilot and the copilot. The controls utilize teflon-lined control cables to reduce friction and binding.

The throttle lever is used to adjust engine RPM. The mixture control lever is used to adjust the air to fuel ratio. The engine is shut down by the placing of the mixture control lever in the full lean position. For information on the leaning procedure, see Section 4 of this Handbook.

The friction adjustment lever on the right side of the control quadrant may be adjusted to increase or decrease the friction holding the throttle and mixture controls or to lock the controls in a selected position.

The carburetor heat control lever is located to the right of the control quadrant on the instrument panel. The control is placarded with two positions: "ON" (down), "OFF" (up).

7.13 FUEL SYSTEM

Fuel is stored in two twenty-five gallon (24 gallons usable) tanks which are secured to the leading edge structure of each wing by screws and nut plates. Each tank is equipped with a filler neck indicator tab to aid in determining fuel remaining when the tanks are not full. Usable capacity to the bottom of the indicator tab is 17 gallons.

The fuel selector control (Figure 7-7) is located on the left side-panel, forward of the pilot's seat. The button on the selector cover must be depressed and held while the handle is moved to the OFF position. The button releases automatically when the handle is moved back into the ON position.

An auxiliary electric fuel pump is provided in case of failure of the engine driven pump. The electric pump should be on for all takeoffs and landings, and when switching tanks. The pump switch is located in the switch panel above the throttle quadrant.

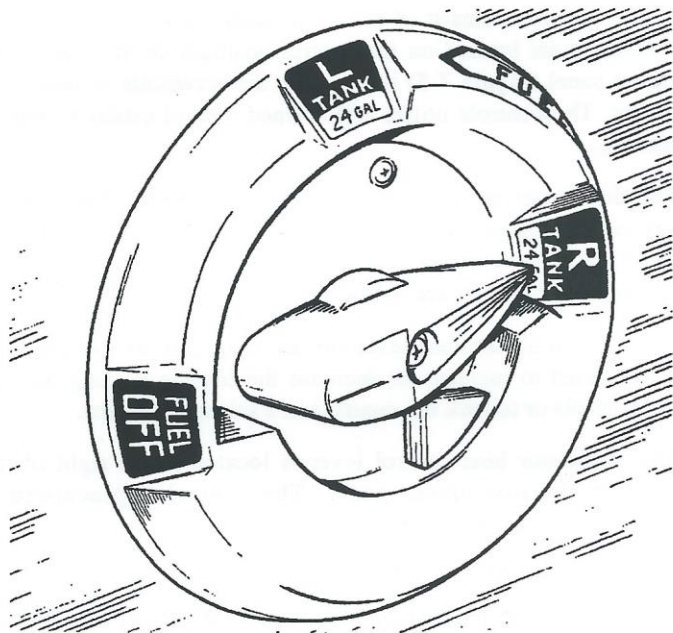

FUEL SELECTOR

Figure 7-7

The fuel drains should be opened daily prior to first flight to check for water or sediment and proper fuel. Each tank has an individual drain at the bottom, inboard rear corner.

A fuel strainer, located on the lower left front of the fire wall, has a drain which is accessible from outside the nose section. The strainer should also be drained before the first flight of the day. Refer to paragraph 8.21 for the complete fuel draining procedure.

A dual fuel quantity gauge is located in lower center of the instrument panel.

An electric engine priming system is provided to facilitate starting. The primer switch is located in the far left side of the overhead switch panel (refer to Figure 7-15A).

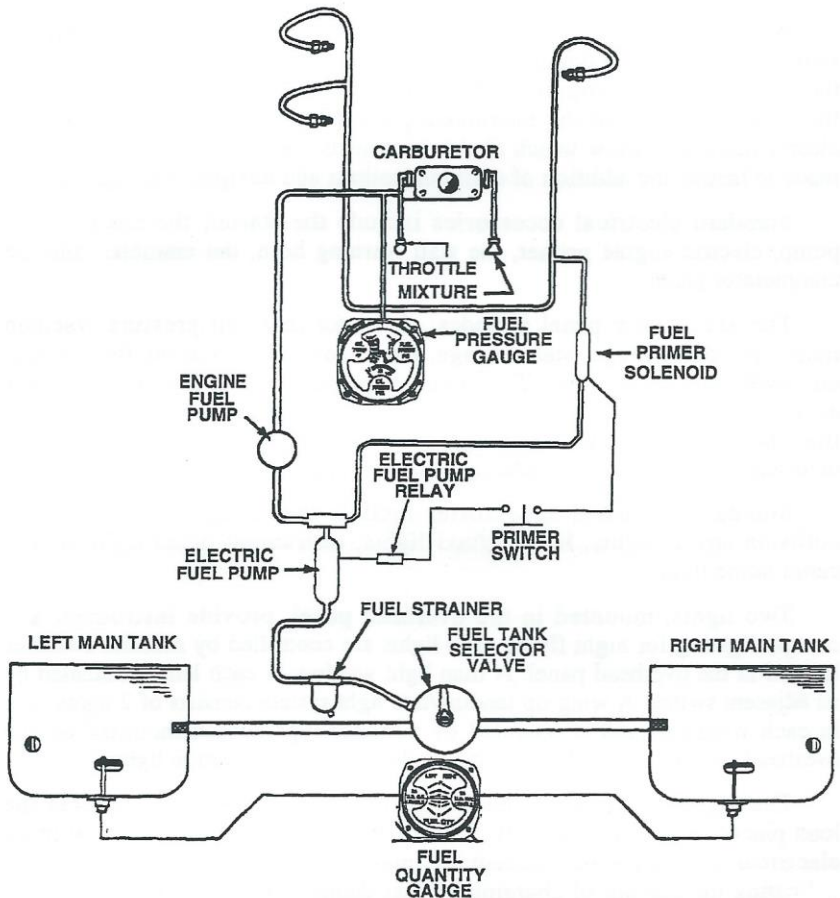

FUEL SYSTEM SCHEMATIC

Figure 7-9

7.15 ELECTRICAL SYSTEM

The 28-volt electrical system includes a 24-volt battery for starting and to back up alternator output. Electrical power is supplied by a 70 ampere alternator. The battery is mounted in a box on the battery shelf located in the aft fuselage. A voltage regulator with integral overvoltage relay is located on the forward left side of the fuselage behind the instrument panel.

SECTION 7
DESCRIPTION & OPERATION

PA-28-181, ARCHER III

All powerplant and exterior lighting switches are grouped in a overhead switch panel, with all avionics switches grouped in a switch panel just above the throttle quadrant (figure 7-15). The circuit breaker panel is located on the lower right side of the instrument panel (figure 7-15). Each breaker is clearly marked to show which circuit it protects. Also, circuit provisions are made to handle the addition of communications and navigational equipment.

Standard electrical accessories include the starter, the electric fuel pump, electric engine primer, the stall warning horn, the ammeter, and the annunciator panel.

The annunciator panel includes, alternator inop, oil pressure, vacuum inop., low bus voltage, start engage, pitot heat and provisions for optional air conditioner door open. The annunciator panel lights are provided only as a warning to the pilot that a system may not be operating properly, and that the applicable system gauge should be checked and monitored to determine when or if any corrective action is required.

Standard electrical accessories include the navigation lights, anti collision strobe lights, landing/taxi lights, instrument panel lighting and cabin dome light.

Two lights, mounted in the overhead panel, provide instrument and cockpit lighting for night flying. The lights are controlled by rheostat switches located in the overhead panel. A map light window in each lens is actuated by an adjacent switch. A wing tip landing/taxi light system consists of 2 lights (one in each wing tip) and is operated by a rocker type switch mounted on the overhead switch panel. (Wing tip lights also used as recognition lights.)

The digital ammeter in the alternator system displays in amperes the load placed on the alternator. It does not indicate battery discharge. With all electrical equipment off (except the master switch) the ammeter will be indicating the amount of charging current demanded by the battery. As each item of electrical equipment is turned on, the current will increase to a total appearing on the ammeter. This total includes the battery. The average continuous load for night flight, with radios on, is about 32 amperes. This 32 ampere value, plus approximately 2 amperes for a fully charged battery, will appear continuously under these flight conditions.

WARNING Anti-collision lights should not be operating when flying through cloud, fog or haze, since the reflected light can produce spatial disorientation. Strobe lights should not be used in close proximity to the ground such as during taxiing, takeoff or landing.

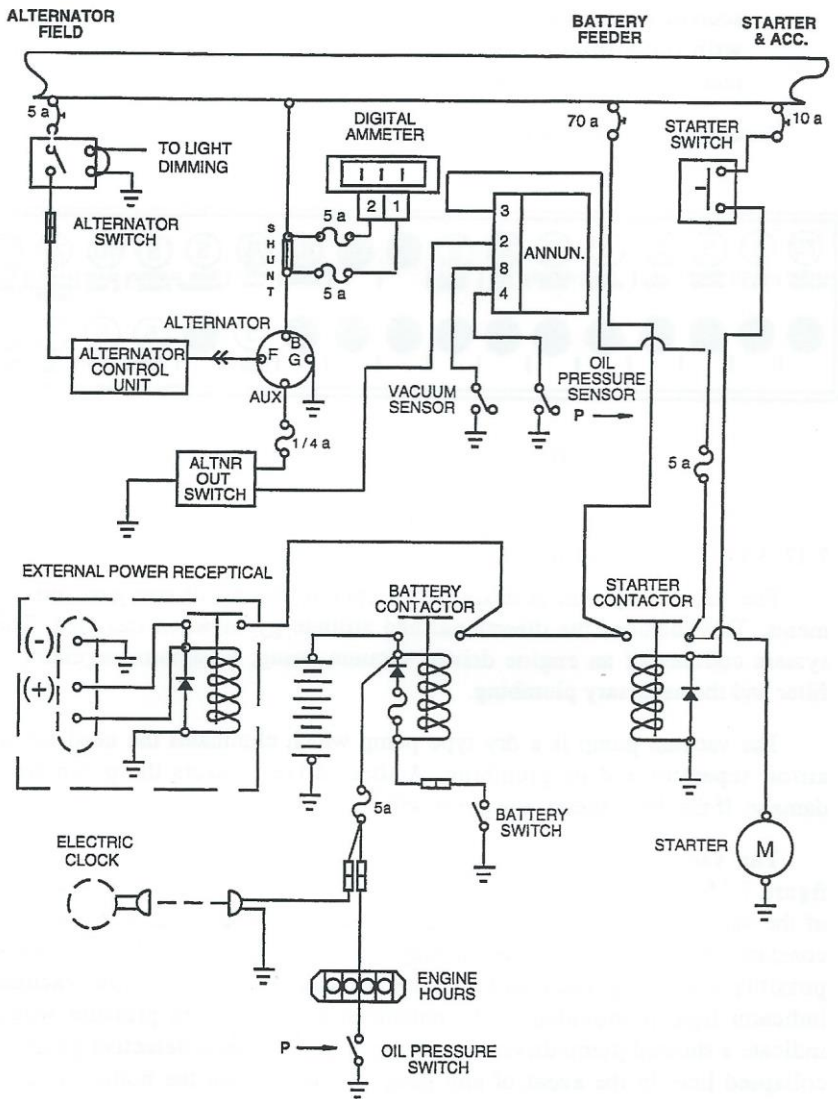

ALTERNATOR AND STARTER SCHEMATIC

Figure 7-11

CAUTION: Do not use cigar lighter receptacles as power sources for any devices other than the cigar lighters supplied with the airplane. Any other device plugged into these receptacles may be damaged.

For abnormal and/or emergency operation and procedure, see Section 3.

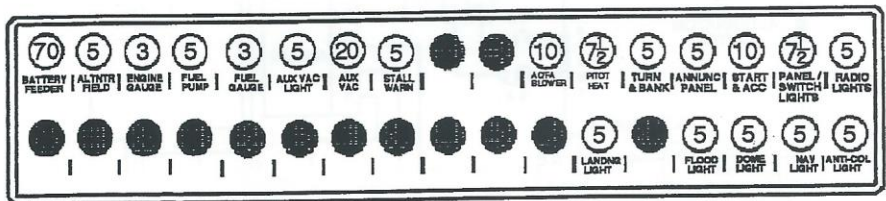

CIRCUIT BREAKER PANEL

Figure 7-13

7.17 VACUUM SYSTEM

The vacuum system is designed to operate the air driven gyro instruments. This includes the directional and attitude gyros when installed. The system consists of an engine driven vacuum pump, a vacuum regulator, a filter and the necessary plumbing.

The vacuum pump is a dry type pump which eliminates the need for an air/oil separator and its plumbing. A shear drive protects the pump from damage. If the drive shears, the gyros will become inoperative.

The vacuum gauge, mounted on the left instrument panel (refer to figure 7-15), provides valuable information to the pilot about the operation of the vacuum system. A decrease in pressure in a system that has remained constant over an extended period may indicate a dirty filter, dirty screens, possibly a sticking vacuum regulator or leak in system (a low vacuum indicator light is provided in the annunciator panel). Zero pressure would indicate a sheared pump drive, defective pump, possibly a defective gauge or collapsed line. In the event of any gauge variation from the norm, the pilot should have a mechanic check the system to prevent possible damage to the system components or eventual failure of the system.

A vacuum regulator is provided in the system to protect the gyros. The valve is set so the normal vacuum reads 4.8 to 5.2 inches of mercury, a setting which provides sufficient vacuum to operate all the gyros at their rated RPM. Higher settings will damage the gyros and with a low setting the gyros will be unreliable. The regulator is located behind the instrument panel and is accessible from below the instrument panel.

7.19 INSTRUMENT PANEL

The instrument panel (Figure 7-15) is designed to accommodate the customary advanced flight instruments and the normally required powerplant instruments. The artificial horizon and directional gyro are vacuum operated and are located in the center of the left hand instrument panel. The vacuum gauge is located on the upper left hand instrument panel with the electric standby vacuum pump switch located directly below. The turn indicator the left side is electrically operated.

The radios are located in the center section of the panel, and the circuit breakers located in the lower right corner of the panel. All avionics switches plus pitot heat are grouped below the left radio stack.

Incorporated in the over head switch panel (7-15A) are all the engine related switches, grouped to the left of center, with exterior lighting switches grouped to the right of center.

Engine gauges are installed to the left of the throttle quadrant for monitoring engine operation. These gauges consist of a combination oil pressure, oil temperature and fuel pressure gauge, optional exhaust gas temperature (EGT), and a tachometer (RPM) gauge.

The normal operating range for ground and flight operation is indicated on the instruments by a green arc. Yellow arcs indicate either a takeoff or precautionary range. Red radial lines identify the established maximum or minimum limits. When an instrument needle point touches the edge of the red radial nearest the yellow or green arc, the limit is met.

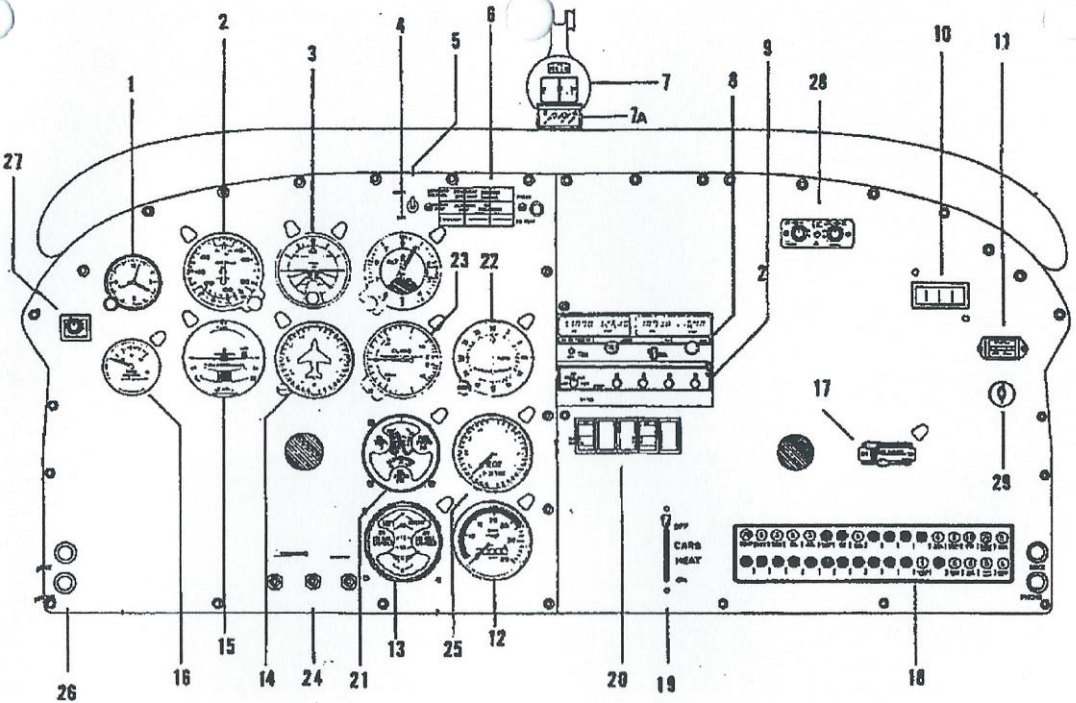

INSTRUMENT PANEL
Figure 7-15

ISSUED: JULY 12, 1995
REVISED: FEBRUARY 5, 2010

REPORT: VB-1611
7-15

1. CLOCK
2. AIRSPEED INDICATOR
3. ATTITUDE GYRO
4. ALTIMETER
5. DAY/NIGHT SWITCH
6. ANNUNCIATOR PANEL (with Press to Test)
7. COMPASS (MAGNETIC)
- 7a. COMPASS CORRECTION CARD
8. COMM / NAV RADIO
9. TRANSPONDER
10. AMMETER (DIGITAL)
11. HOUR METER
12. TACHOMETER (RPM)
13. FUEL QUANTITY
14. DIRECTIONAL GYRO
15. TURN & BANK
16. VACUUM GAUGE or Optional EGT (Exhaust Gas Temperature Gauge) when Garmin G500 installed.
17. CABIN AIR CONTROL
WINDSHIELD DEFROST AND HEAT
18. CIRCUIT BREAKER PANEL
19. CARB. HEAT
20. SWITCH PANEL (Avionics - Pitot Heat)
21. ENGINE GAUGE, OIL TEMP
OIL AND FUEL PRESSURE, .
22. VOR/LOC NAVIGATION INDICATOR
23. VERTICAL SPEED INDICATOR
24. LIGHT CONTROL AND DIMMING
SWITCH, INST.PANEL,& RADIOS
25. OPTIONAL EGT (Exhaust Gas Temperature Gauge) when Standard Instrument Package installed.
26. MIC/PHONE JACKS
27. ELT CONTROL
28. INTERCOM CONTROL
29. CIGAR LIGHTER

Typical VFR Panel

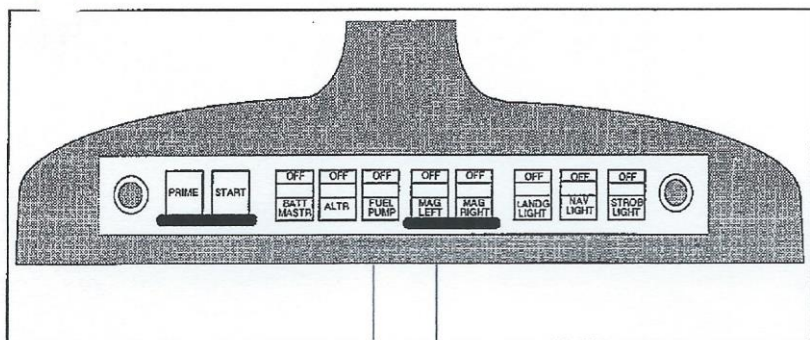

OVERHEAD SWITCH PANEL

Figure 7-15A

Overhead switches: (left to right)

- Left Panel Flood Light Control
- Engine Primer
- Engine Starter
- Battery Master
- Alternator
- Fuel Pump
- Left Magneto
- Right Magneto
- Landing Light / Taxi Light
- Nav Light
- Strobe Light
- Right Panel Flood Light Control

THIS PAGE INTENTIONALLY LEFT BLANK

7.21 PITOT-STATIC SYSTEM

The system supplies both pitot and static pressure for the airspeed indicator, altimeter and the-vertical speed indicator (Figure 7-17).

Pitot and static pressure are picked up by a pitot head installed on the bottom of the left wing and carried through pitot and static lines within the wing and fuselage to the gauges on the instrument panel.

An alternate static source is standard equipment. The control valve is located below the left side of the instrument panel. When the valve is set in the alternate position, the altimeter, vertical speed indicator and airspeed indicator will be using cabin air for static pressure. The storm window and cabin vents must be closed and the cabin heater and defroster must be on during alternate static source operation. The altimeter error is less than 50 feet unless otherwise placarded.

Both the pitot and static lines can be drained through separate drain valves located on the left lower side of the fuselage interior.

A heated pitot head, which alleviates problems with icing and heavy rain, is standard equipment. The switch for the heated pitot head is located on the electrical switch panel above the throttle quadrant.

To prevent bugs and water from entering the pitot and static pressure holes, a cover should be placed over the pitot head. A partially or completely blocked pitot head will give erratic or zero readings on the instruments.

NOTE

During the preflight, check to make sure the pitot cover is removed.

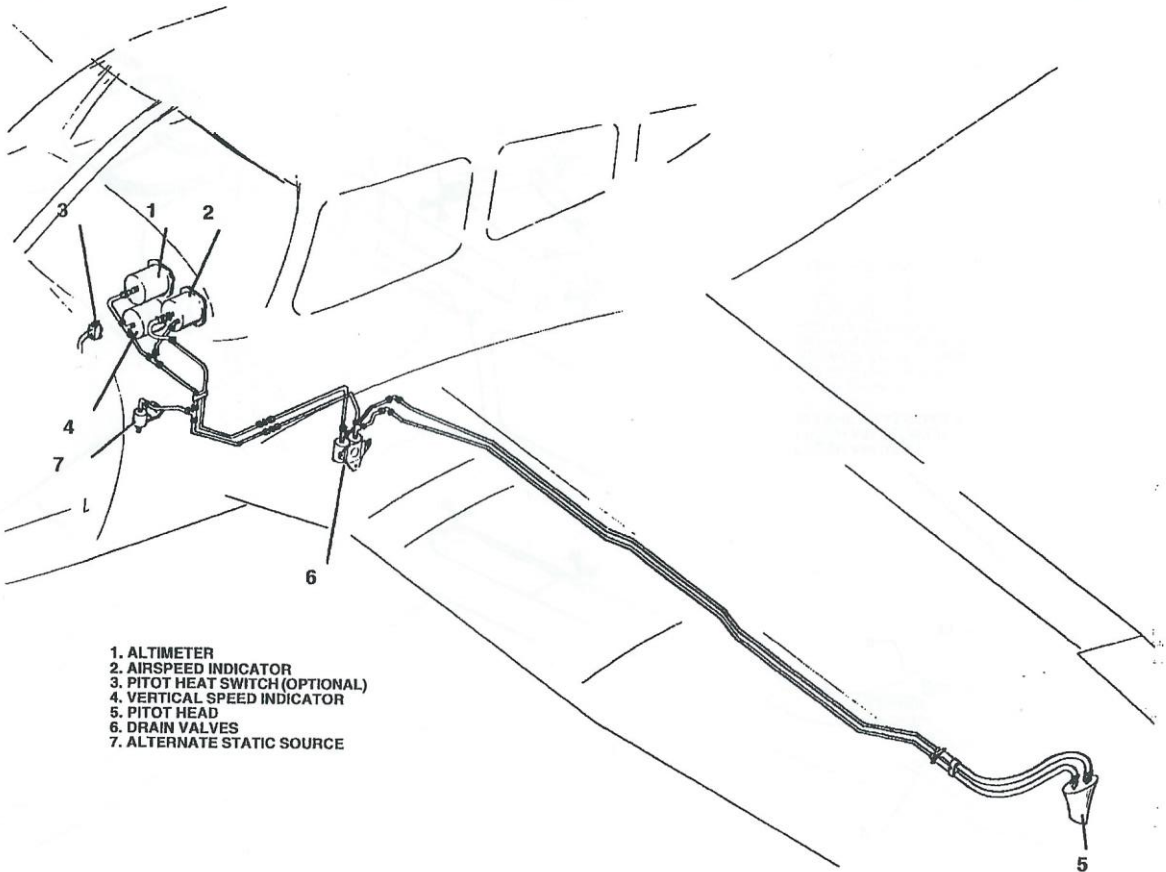

- 1. ALTIMETER
- 2. AIRSPEED INDICATOR
- 3. PITOT HEAT SWITCH (OPTIONAL)
- 4. VERTICAL SPEED INDICATOR
- 5. PITOT HEAD
- 6. DRAIN VALVES
- 7. ALTERNATE STATIC SOURCE

PITOT-STATIC SYSTEM

Figure 7-17

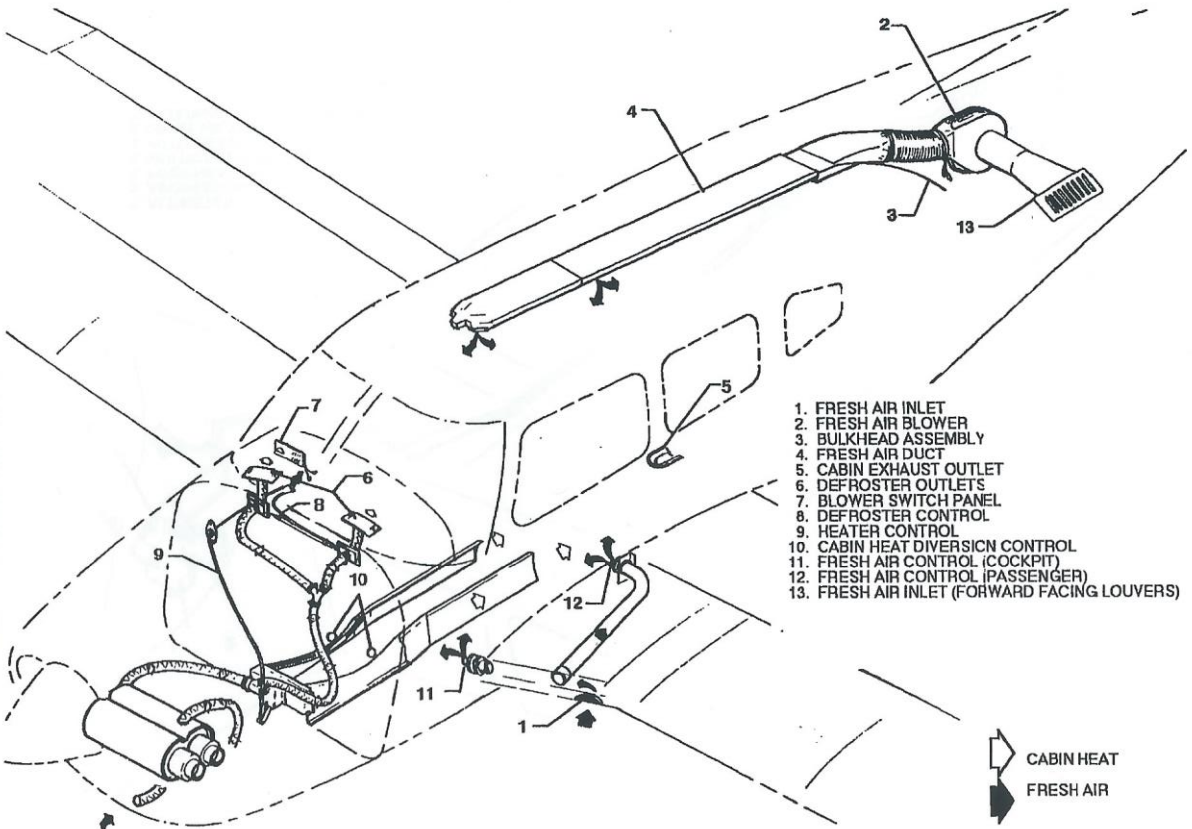

- 1. FRESH AIR INLET
- 2. FRESH AIR BLOWER
- 3. BULKHEAD ASSEMBLY
- 4. FRESH AIR DUCT
- 5. CABIN EXHAUST OUTLET
- 6. DEFROSTER OUTLETS
- 7. BLOWER SWITCH PANEL
- 8. DEFROSTER CONTROL
- 9. HEATER CONTROL
- 10. CABIN HEAT DIVERSION CONTROL
- 11. FRESH AIR CONTROL (COCKPIT)
- 12. FRESH AIR CONTROL (PASSENGER)
- 13. FRESH AIR INLET (FORWARD FACING LOUVERS)

 CABIN HEAT
 FRESH AIR

HEATING AND VENTILATING SYSTEM

Figure 7-19

7.23 HEATING AND VENTILATING SYSTEM

Heat for the cabin interior and the defroster system is provided by a heater muff attached to the exhaust system (Figure 7-19). The amount of heat desired can be regulated with the controls located on the far right side of the instrument panel.

The air flow can be regulated between the front and rear seats by levers located on top of the heat ducts next to the console.

Fresh air inlets are located in the leading edge of the wing near the fuselage. An adjustable outlet is located on the side of the cabin near the floor at each seat location; overhead air outlets are offered as optional equipment. Air is exhausted through an outlet under the rear seat. A cabin air blower, incorporated in the ventilating system, is also available as optional equipment. An optional overhead ventilating system with a cabin air blower is available on models without air conditioning. This blower is operated by a FAN switch with 3 positions - "OFF," "LOW," "HIGH."

CAUTION

When cabin heat is operated, heat duct surface becomes hot. This could result in burns if arms or legs are placed too close to heat duct outlets or surface.

7.25 CABIN FEATURES

For ease of entry and exit and pilot-passenger comfort, the front seats are adjustable fore and aft. The rear seats may be removed to provide room for bulky items. Rear seat installations incorporate leg retainers with latching mechanisms which must be released before the rear seats can be removed. Releasing the retainers is accomplished on by depressing the plunger behind each rear leg. Armrests are also provided for the front seats. All seats are available with optional headrests and optional vertical adjustment may be added to the front seats.

A cabin interior includes a pilot storm window, two sun visors, ash trays, two map pockets, and pockets on the backs of each front seat.

Shoulder harnesses with inertia reels are provided as standard equipment for the occupants of both front and rear seats. A check of the inertia reel mechanism can be made by pulling sharply on the strap and checking that the reel will lock in place under sudden stress. This locking feature prevents the strap from extending, and holds the occupant in place. Under normal movement the strap will extend and retract as required. The shoulder strap is routed over the shoulder adjacent to the windows and attached to the lap belt in the general area of the person's inboard hip. Adjust this fixed strap so that all controls are accessible while maintaining adequate restraint for the occupant. Shoulder harnesses should be routinely worn during takeoff, landing, turbulent air, and whenever an inflight emergency situation occurs.

7.27 BAGGAGE AREA

A 24 cubic foot baggage area, located behind the rear seats, is accessible either from the cabin or through an outside baggage door on the right side of the aircraft. Maximum capacity is 200 pounds. Tie-down straps are provided and should be used at all times.

NOTE

It is the pilot's responsibility to be sure when the baggage is loaded that the aircraft C.G. falls within the allowable C.G. Range (refer to Section 6 - Weight and Balance).

7.29 STALL WARNING

An approaching stall is indicated by a stall warning horn which is activated between five and ten knots above stall speed. Mild airframe buffeting and gentle pitching may also precede the stall. Stall speeds are shown on graphs in the Performance Section. The stall warning horn emits a continuous sound and is activated by a lift detector installed on the leading edge of the left wing. During preflight, the stall warning system should be checked by turning the master switch ON, lifting the detector and checking to determine if the horn is actuated.

7.31 FINISH

All exterior surfaces are primed with etching primer and finished with a polyurethane finish.

7.33 AIR CONDITIONING*

The air conditioning system is a recirculating air system. The major items include: evaporator, condenser, compressor, blower, switches and temperature controls.

The evaporator is located behind the left rear side of the baggage compartment. This cools the air that is used for air conditioning.

The condenser is mounted on a retractable scoop located on the bottom of the fuselage and to the rear of the baggage compartment area. The scoop extends when the air conditioner is ON and retracts to a flush position when the system is OFF.

The compressor is mounted on the forward right underside of the engine. It has an electric clutch which automatically engages or disengages the compressor to the belt drive system of the compressor.

An electrical blower is mounted on the aft side of the rear cabin panel. Air from the baggage area is drawn through the evaporator by the blower and distributed through an overhead duct to individual outlets located adjacent to each occupant.

The switches and temperature control are located on the lower right side of the instrument panel in the climate control center panel. The temperature control regulates the desired temperature of the cabin. Turn the control clockwise for increased cooling, counterclockwise for decreased cooling.

*Optional equipment

Located inboard of the temperature control is the fan speed switch and the air conditioning ON-OFF switch. The fan can be operated independently of the air conditioning. However, it must be on for air conditioner operation. Turning either switch off will disengage the compressor clutch and retract the condenser door. Cooling air should be felt within one minute after the air conditioner is turned on.

NOTE

If the system is not operating in 5 minutes, turn the system OFF until the fault is corrected.

The FAN switch allows operation of the fan with the air conditioner turned OFF to aid cabin air circulation if desired. A LOW or HIGH flow of air can be selected to the air conditioner outlets located in the overhead duct. The outlets can be adjusted or turned off by each occupant to regulate individual cooling effect.

The "DOOR OPEN" indicator light is located in the annunciator panel. The light illuminates whenever the condenser door is open and remains on until the door is closed.

A circuit breaker located on the circuit breaker panel protects the air conditioning electrical system.

Whenever the throttle is in the full throttle position, it actuates a micro switch which disengages the compressor and retracts the scoop. This is done to obtain maximum power and maximum rate of climb. The fan continues to operate and the air will remain cool for approximately one minute. When the throttle is retarded approximately 1/4 inch, the clutch will engage and the scoop will extend, again supplying cool, dry air.

7.35 EXTERNAL POWER

An external power installation is accessible through a receptacle located on the right side of the fuselage aft of the wing. An external battery can be connected to the socket, thus allowing the operator to crank the engine without having to gain access to the airplane's battery.

7.37 EMERGENCY LOCATOR TRANSMITTER*

The Emergency Locator Transmitter (ELT), is located in the aft portion of the fuselage just below the stabilator leading edge and is accessible through a plate on the right side of the fuselage. This plate is attached with slotted-head nylon screws for ease of removal; these screws may be readily removed with a variety of common items such as a dime, a key, a knife blade, etc. If there are no tools available in an emergency the screw heads may be broken off by any means.

A battery replacement date is marked on the transmitter to comply with FAA regulations, the battery must be replaced on or before this date. The battery must also be replaced if the transmitter has been used in an emergency situation or if the accumulated test time exceeds one hour, or if the unit has been inadvertently activated for an undetermined time period.

NOTE

If for any reason a test transmission is necessary, the test transmission should be conducted only in the first five minutes of any hour and limited to three audio sweeps. If the tests must be made at any other time, the tests should be coordinated with the nearest FAA tower or flight service station.

*Optional equipment

TEXT ELT OPERATION

On the ELT unit itself is a two position switch placarded ON and OFF. The OFF position is selected when the transmitter is installed at the factory and the switch should remain in that position whenever the unit is installed in the airplane.

A pilots remote switch, placarded ON and ARM is located on the left hand side of the pilot's instrument panel to allow the transmitter to be armed or turned on from inside the cabin. The switch is normally in ARM position. Moving the switch to ON will activate the transmitter. A warning light located above the remote switch will alert you when ever the ELT is activated.

The ME-406 ELT (406 MHz), if installed, is equipped with a warning buzzer. This warning buzzer, which receives power from the ELT itself, is mounted in the tailcone. When the ELT is activated the buzzer "beeps" periodically. The time between pulses lengthens after a predetermined transmitter "ON" time. The buzzer is loud enough to be heard from outside the aircraft when the engine is not running.

Should the ELT be activated inadvertently it can be reset by either positioning the remote switch to the ON then immediately relocating it to the ARM position, or by setting the switch on the ELT to ON and then back to OFF.

In the event the transmitter is activated by an impact, it can be turned off by moving the switch on the ELT to ON and then back to OFF. Normal operation can then be restored by resetting the switch to ARM. It may also be turned off and reset by positioning the remote switch to the ON and then immediately to the ARM position.

The transmitter can be activated manually at any time by placing either the remote switch or the ELT switch to the ON position.

NOTE:

Three sweeps of the emergency tone and an illuminated warning light indicates a normally functioning unit. The warning light must illuminate during the first 3 second test period. If it does not illuminate, a problem is indicated such as a "G" switch failure.

The ELT should be checked during postflight to make certain the unit has not been activated. Check by selecting 121.50 MHz on an operating receiver. If a downward sweeping audio tone is heard the ELT may have been activated. Move the remote switch to ON. If there is no change in the volume of the signal, your airplane's ELT is probably transmitting. Setting the remote switch back to OFF will automatically reset the ELT and should stop the signal being received on 121.50 MHz.

7.39 *CARBURETOR ICE DETECTION SYSTEM

A carburetor ice detection system is available as optional equipment.

The system consists of a control box mounted on the instrument panel, a probe sensor mounted in the carburetor and a red warning light to indicate the presence of ice in the carburetor. If ice is present apply full carburetor heat. Refer to Carburetor Icing, Section 3, Emergency Procedures. To adjust the system for critical ice detection, first turn on the airplanes master switch and then turn on the ice detection unit. Turn the sensitivity knob fully counterclockwise causing the carb. ice light to come on. Now rotate the sensitivity knob back (clockwise) until the ice light just goes out. This establishes the critical setting.

WARNING

This instrument is approved as optional equipment only and Flight Operations should not be predicated on its use.

*Optional equipment

THIS PAGE INTENTIONALLY LEFT BLANK

TABLE OF CONTENTS
SECTION 8
AIRPLANE HANDLING, SERVICING AND MAINTENANCE

Paragraph No.		Page No.
8.1	General	8-1
8.3	Airplane Inspection Periods	8-2
8.5	Preventive Maintenance	8-3
8.7	Airplane Alterations	8-4
8.9	Ground Handling	8-5
8.11	Engine Air Filter	8-8
8.13	Brake Service	8-8
8.15	Landing Gear Service	8-10
8.17	Propeller Service	8-11
8.19	Oil Requirements	8-12
8.21	Fuel System	8-12
8.23	Tire Inflation	8-16
8.25	Battery Service	8-16
8.27	Cleaning	8-17
8.29	Cold Weather Operation	8-20

THIS PAGE INTENTIONALLY LEFT BLANK

8.1 GENERAL (CONTINUED)

Every owner should stay in close contact with an authorized Piper Service Center or Piper's Customer Service Department to obtain the latest information pertaining to their airplane, and to avail themselves of Piper's support systems.

Piper takes a continuing interest in having owners get the most efficient use from their airplane and keeping it in the best mechanical condition. Consequently, Piper, from time to time, issues service releases including Service Bulletins, Service Letters, Service Spares Letters, and others relating to the airplane.

Piper Service Bulletins are of special importance and Piper considers compliance mandatory. These are available on the Piper.com website. Depending on the nature of the release, material and labor allowances may apply. This information is provided to all authorized Piper Service Centers.

Service Letters deal with product improvements and servicing techniques pertaining to the airplane. They are available on the Piper.com website. Owners should give careful attention to Service Letter information.

Service Spares Letters offer improved parts, kits, and optional equipment which were not available originally, and which may be of interest to the owner.

Maintenance manuals, parts catalogs, and revisions to both, are available from Piper Service Centers.

Any correspondence regarding the airplane should include the airplane model and serial number to ensure proper response.

8. AIRPLANE INSPECTION PERIODS

WARNING

All inspection intervals, replacement time limits, overhaul time limits, the method of inspection, life limits, cycle limits, etc., recommended by PIPER are solely based on the use of new, remanufactured or overhauled PIPER approved parts. If parts are designed, manufactured, remanufactured, overhauled and/or approved by entities other than PIPER, then the data in PIPER'S maintenance/service manuals and parts catalogs are no longer applicable and the purchaser is warned not to rely on such data for non-PIPER parts. All inspection intervals, replacement time limits, overhaul time limits, the method of inspection, life limits, cycle limits, etc., for such non-PIPER parts must be obtained from the manufacturer and/or seller of such non-PIPER parts.

Piper has developed inspection items and required inspection intervals for the PA-28-181 (see the latest revision of the PA-28-181 Maintenance and Inspection Manuals). The PA-28-181 Inspection Manual contains appropriate forms, and all inspection procedures should be complied with by a properly trained, knowledgeable, and qualified mechanic at a Piper Authorized Service Center or a reputable repair shop. Piper cannot accept responsibility for the continued airworthiness of any aircraft not maintained to these standards, and/or not brought into compliance with applicable Service Bulletins issued by Piper, instructions issued by the engine, propeller, or accessory manufacturers, or Airworthiness Directives issued by the FAA.

A programmed Inspection, approved by the Federal Aviation Administration (FAA), is also available to the owner. This involves routine and detailed inspections to allow maximum utilization of the airplane. Maintenance inspection costs are reduced, and the maximum standard of continued airworthiness is maintained. Complete details are available from Piper.

In addition, but in conjunction with the above, the FAA requires periodic inspections on all aircraft to keep the Airworthiness Certificate in effect. The owner is responsible for assuring compliance with these inspection requirements and/or maintaining proper documentation in logbooks and/or maintenance records.

A spectrographic analysis of the engine oil is available from several sources. This inspection, if performed properly, provides a good check of the internal condition of the engine. To be accurate, induction air filters must be cleaned or changed regularly, and oil samples must be taken and sent in at regular intervals.

8.5 PREVENTIVE MAINTENANCE

The holder of a pilot certificate issued under Federal Aviation Regulations (FAR) Part 61 may perform certain preventive maintenance as defined in the FARs. This maintenance may be performed only on an aircraft which the pilot owns and operates, and which is not used in air carrier or air taxi/commercial operations service.

All other maintenance must be accomplished by a person or facility appropriately certificated by the Federal Aviation Administration (FAA) to perform that work.

Anytime maintenance is accomplished, an entry must be made in the appropriate aircraft maintenance records. The entry shall include:

- (a) The date the work was accomplished.
- (b) Description of the work.
- (c) Number of hours on the aircraft.
- (d) The certificate number of pilot performing the work.
- (e) Signature of the individual doing the work.

8.7 AIRPLANE ALTERATIONS

If the owner desires to have his aircraft modified, he must obtain FAA approval for the alteration. Major alterations accomplished in accordance with Advisory Circular 43.13-2, when performed by an A & P mechanic, may be approved by the local FAA office. Major alterations to the basic airframe or systems not covered by AC 43.13-2 require a Supplemental Type Certificate.

The owner or pilot is required to ascertain that the following Aircraft Papers are in order and in the aircraft.

- (a) To be displayed in the aircraft at all times:
 - (1) Aircraft Airworthiness Certificate Form FAA-8100-2.
 - (2) Aircraft Registration Certificate Form FAA-8050-3.
 - (3) Aircraft Radio Station License if transmitters are installed.

- (b) To be carried in the aircraft at all times:
 - (1) Pilot's Operating Handbook.
 - (2) Weight and Balance data plus a copy of the latest Repair and Alteration Form FAA-337, if applicable.
 - (3) Aircraft equipment list.

Although the aircraft and engine logbooks are not required to be in the aircraft, they should be made available upon request. Logbooks should be complete and up to date. Good records will reduce maintenance cost by giving the mechanic information about what has or has not been accomplished.

8.9 GROUND HANDLING

(a) Towing

The airplane may be moved on the ground by the use of the nose wheel steering bar that is stowed below the forward ledge of the baggage compartment or by power equipment that will not damage or excessively strain the nose gear steering assembly. Towing lugs are incorporated as part of the nose gear fork.

CAUTION

When towing with power equipment, do not turn the nose gear beyond its steering radius in either direction, as this will result in damage to the nose gear and steering mechanism.

CAUTION

Do not tow the airplane when the controls are secured.

In the event towing lines are necessary, ropes should be attached to both main gear struts as high up on the tubes as possible. Lines should be long enough to clear the nose and/or tail by not less than fifteen feet, and a qualified person should ride in the pilot's seat to maintain control by use of the brakes.

(b) Taxiing

Before attempting to taxi the airplane, ground personnel should be instructed and approved by a qualified person authorized by the owner. Engine starting and shut-down procedures as well as taxi techniques should be covered. When it is ascertained that the propeller back blast and taxi areas are clear, power should be applied to start the taxi roll, and the following checks should be performed:

- (1) Taxi a few feet forward and apply the brakes to determine their effectiveness.
- (2) While taxiing, make slight turns to ascertain the effectiveness of the steering.
- (3) Observe wing clearance when taxiing near buildings or other stationary objects. If possible, station an observer outside the airplane.
- (4) When taxiing over uneven ground, avoid holes and ruts.
- (5) Do not operate the engine at high RPM when running up or taxiing over ground containing loose stones, gravel, or any loose material that may cause damage to the propeller blades.

(c) Parking

When parking the airplane, be sure that it is sufficiently protected from adverse weather conditions and that it presents no danger to other aircraft. When parking the airplane for any length of time or overnight, it is suggested that it be moored securely.

- (1) To park the airplane, head it into the wind if possible.
- (2) Set the parking brake by pulling back on the brake lever and depressing the knob on the handle. To release the parking brake, pull back on the handle until the catch disengages; then allow the handle to swing forward.

CAUTION

Care should be taken when setting brakes that are overheated or during cold weather when accumulated moisture may freeze a brake.

- (3) Aileron and stabilator controls should be secured with the front seat belt and chocks used to properly block the wheels.

(d) Mooring

The airplane should be moored for immovability, security and protection. The following procedures should be used for the proper mooring of the airplane:

- (1) Head the airplane into the wind if possible.
- (2) Retract the flaps.
- (3) Immobilize the ailerons and stabilator by looping the seat belt through the control wheel and pulling it snug.
- (4) Block the wheels.
- (5) Secure tie-down ropes to the wing tie-down rings and to the tail skid at approximately 45 degree angles to the ground. When using rope of non-synthetic material, leave sufficient slack to avoid damage to the airplane should the ropes contract.

CAUTION

Use bowline knots, square knots or locked slip knots. Do not use plain slip knots.

NOTE

Additional preparations for high winds include using tie-down ropes from the landing gear forks and securing the rudder.

- (6) Install a pitot head cover if available. Be sure to remove the pitot head cover before flight.
- (7) Cabin and baggage doors should be locked when the airplane is unattended.

8.11 ENGINE AIR FILTER

Inspect inlet for foreign particles and obstructions. Engine Air Filter should be removed and inspected or replaced at intervals as outlined in aircraft Maintenance Manual. Operations in severe environments may require more frequent attention.

8.13 BRAKE SERVICE

The brake system is filled with MIL-H-5606 (petroleum base) hydraulic brake fluid. The fluid level should be checked periodically or at every 50-hour inspection and replenished when necessary. The brake reservoir is located on the fire wall in the engine compartment. If the entire system must be refilled, fill with fluid under pressure from the brake end of the system. This will eliminate air from the system.

No adjustment of the brake clearances is necessary. If after extended service brake blocks become excessively worn, they should be replaced with new segments.

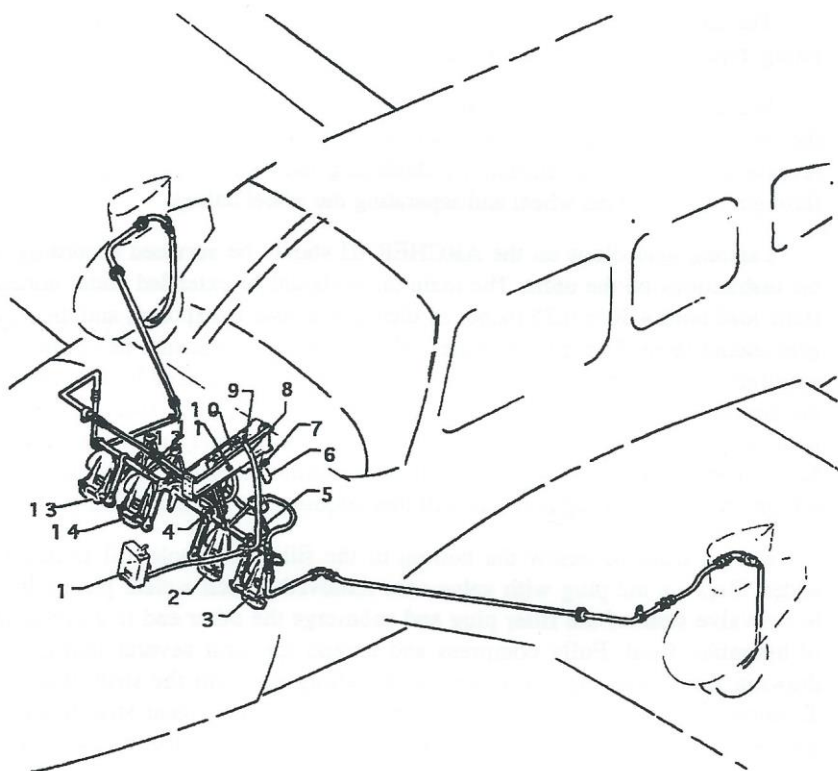

1. BRAKE RESERVOIR
2. RIGHT BRAKE AND RUDDER PEDAL
3. LEFT BRAKE AND RUDDER PEDAL
4. RIGHT BRAKE CYLINDER
5. LEFT BRAKE CYLINDER
6. BRAKE HANDLE
7. HANDLE RELEASE BUTTON
8. LINE, INLET
9. CLEVIS PIN
10. MASTER CYLINDER ASSEMBLY
11. BOLT ASSEMBLY
12. TORQUE TUBE
13. COPILOT'S RIGHT BRAKE AND RUDDER PEDAL
14. COPILOT'S LEFT BRAKE AND RUDDER PEDAL

BRAKE SYSTEM

Figure 8-1

8.15 LANDING GEAR SERVICE

The three landing gears use Cleveland Aircraft Products 6.00 x 6, four-ply rating, type III tires with tubes. (Refer to paragraph 8.23).

Wheels are removed by taking off the hub cap, cotter pin, axle nut, and the two bolts holding the brake segment in place. Mark tire and wheel for reinstallation; then dismount by deflating the tire, removing the three through-bolts from the wheel and separating the wheel halves.

Landing gear oleos on the ARCHER III should be serviced according to the instructions on the units. The main oleos should be extended under normal static load until 4.50 ± 0.25 inches of oleo piston tube is exposed, and the nose gear should show 3.25 ± 0.25 inches. Should the strut exposure be below that required, it should be determined whether air or oil is required by first raising the airplane on jacks. Depress the valve core to allow air to escape from the strut housing chamber. Remove the filler plug and slowly raise the strut to full compression. If the strut has sufficient fluid, it will be visible up to the bottom of the filler plug hole and will then require only proper inflation.

Should fluid be below the bottom of the filler plug hole, oil should be added. Replace the plug with valve core removed; attach a clear plastic hose to the valve stem of the filler plug and submerge the other end in a container of hydraulic fluid. Fully compress and extend the strut several times, thus drawing fluid from the container and expelling air from the strut chamber. To allow fluid to enter the bottom chamber of the main gear strut housing, the torque link assembly must be disconnected to let the strut be extended a minimum of 10 inches (the nose gear torque links need not be disconnected). Do not allow the strut to extend more than 12 inches. When air bubbles cease to flow through the hose, compress the strut fully and again check fluid level. Reinstall the valve core and filler plug, and the main gear torque links, if disconnected.

With fluid in the strut housing at the correct level, attach a strut pump to the air valve and with the airplane on the ground, inflate the oleo strut to the correct height.

In jacking the aircraft for landing gear or other service, two hydraulic jacks and a tail stand should be used. At least 250 pounds of ballast should be placed on the base of the tail stand before the airplane is jacked up. The hydraulic jacks should be placed under the jack points on the bottom of the wing and the airplane jacked up until the tail skid is at the right height to attach the tail stand. After the tail stand is attached and the ballast added, jacking may be continued until the airplane is at the height desired.

The steering arms from the rudder pedals to the nose wheel are adjusted at the nose wheel by turning the threaded rod end bearings in or out. Adjustment is normally accomplished at the forward end of the rods and should be done in such a way that the nose wheel is in line with the fore and aft axis of the plane when the rudder pedals and rudder are centered. Alignment of the nose wheel can be checked by pushing the airplane back and forth with the rudder centered to determine that the plane follows a perfectly straight line. The turning arc of the nose wheel is $30.0^\circ + 2^\circ$ in either direction and is limited by stops on the bottom of the forging.

The rudder pedal arm stops should be carefully adjusted so that the pedal arms contact the stops just after the rudder hits its stops. This guarantees that the rudder will be allowed to move through its full travel.

8.17 PROPELLER SERVICE

The spinner and backing plate should be frequently cleaned and inspected for cracks. Before each flight the propeller should be inspected for nicks, scratches, and corrosion. If found, they should be repaired as soon as possible by a rated mechanic, since a nick or scratch causes an area of increased stress which can lead to serious cracks or the loss of a propeller tip. The back face of the blades should be painted when necessary with flat black paint to retard glare. To prevent corrosion, the surface should be cleaned and waxed periodically.

8.19 OIL REQUIREMENTS

The oil capacity of the engine is 8 quarts and the minimum safe quantity is 2 quarts. It is recommended that the oil be drained and renewed, and the screen cleaned, every 25 hours. However, if the full flow (cartridge type) oil filter is used, the oil and filter should be drained and renewed every 50 hours of operation. The interval between oil and oil filter change is not to exceed four (4) months. The following grades are recommended for the specified temperatures:

Average Ambient Air Temperature	MIL-L-6082B Mineral SAE Grade	MIL-L-22851 Ashless Dispersant SAE Grades
All Temperatures	--	15W-50 or 20W-50
Above 80°F	60	60
Above 60°F	50	40 or 50
30°F to 90°F	40	40
0°F to 70°F	30	30, 40 or 20W-40
Below 10°F	20	30 or 20W-30

When operating temperatures overlap indicated ranges, use the lighter grade oil.

NOTE

Refer to the latest issue of Lycoming Service Instruction 1014 (Lubricating Oil Recommendations) for further information.

8.21 FUEL SYSTEM

(a) Servicing Fuel System

At every 50 hour inspection, the fuel screens in the strainer, in the electric fuel pump, and at the carburetor inlet must be cleaned.

(b) Fuel Requirements (AVGAS ONLY)

The minimum aviation grade fuel for the PA-28-181 is 100. Since the use of lower grades can cause serious engine damage in a short period of time, the engine warranty is invalidated by the use of lower octanes.

Whenever 100 or 100LL grade fuel is not available, commercial grade 100/130 should be used. (See Fuel Grade Comparison Chart.) Refer to the latest issue of Lycoming Service Instruction No. 1070 for additional information.

A summary of the current grades as well as the previous fuel designations is shown in the following chart:

FUEL GRADE COMPARISON CHART

Previous Commercial Fuel Grades (ASTM-D910)			Current Commercial Fuel Grades (ASTM-D910-75)			Current Military Fuel Grades (MIL-G-5572F)		
Grade	Color	Max. TEL ml/U.S. gal	Grade	Color	Max. TEL ml/U.S. gal	Grade	Color	Max. TEL ml/U.S. gal
80/87	red	0.5	80	red	0.5	80/87	red	0.5
91/96	blue	2.0	*100LL	blue	2.0	none	none	none
100/130	green	3.0	100	green	**3.0	100/130	blue	2.0
115/145	purple	4.6	none	none	none	115/145	purple	4.6

* -Grade 100LL fuel in some overseas countries is colored green and designated as "100L".

** -Commercial fuel grade 100 and grade 100/130 having TEL content of up to 4 ml/U.S. gallons are approved for use in all engines certificated for use with grade 100/130 fuel.

The operation of the aircraft is approved with an anti-icing additive in the fuel. When an anti-icing additive is used it must meet the specification MIL-I-27686, must be uniformly blended with the fuel while refueling, must not exceed .15% by volume of the refueled quantity, and to ensure its effectiveness should be blended at not less than .10% by volume. One and one half liquid ozs. per ten gallon of fuel would fall within this range. A blender supplied by the additive manufacturer should be used. Except for the information contained in this section, the manufacturer's mixing or blending instructions should be carefully followed.

CAUTION

Assure that the additive is directed into the flowing fuel stream. The additive flow should start after and stop before the fuel flow. Do not permit the concentrated additive to come in contact with the aircraft painted surfaces or the interior surfaces of the fuel tanks.

CAUTIONS

Some fuels have anti-icing additives pre-blended in the fuel at the refinery, so no further blending should be performed.

Fuel additive can not be used as a substitute for preflight draining of the the fuel system drains.

(c) Filling Fuel Tanks

Observe all required precautions for handling gasoline. Fill the fuel tanks through the filler located on the forward slope of the wing. Each wing holds a maximum of 25 U.S. gallons. When using less than the standard 50 gallon capacity, fuel should be distributed equally between each tank. There is approximately 17 gallons in the fuel tank when fuel level is even with bottom of filler neck indicator.

(d) Draining Fuel Strainer, Sumps and Lines

The fuel tank sumps and strainer should be drained daily prior to the first flight and after refueling to avoid the accumulation of contaminant's such as water or sediment. Each fuel tank is equipped with an individual quick drain located at the lower inboard rear corner of the tank. The fuel strainer is equipped with a quick drain located on the front lower corner of the fire wall. Each of the fuel tank sumps should be drained first. Then the fuel strainer should be drained twice, once with the fuel selector valve on each tank. Each time fuel is drained, sufficient fuel should be allowed to flow to ensure removal of contaminant's. This fuel should be collected in a suitable container, examined for contaminant's, and then discarded.

CAUTION

When draining any amount of fuel, care should be taken to ensure that no fire hazard exists before starting the the engine.

Each quick drain should be checked after closing it to make sure it has closed completely and is not leaking.

**FUEL DRAIN**

Figure 8-3

(e) Draining Fuel System

The bulk of the fuel may be drained from the system by opening the valve at the inboard end of each fuel tank. Push up on the arms of the drain valve and turn counterclockwise to hold the drain open. The remaining fuel in the system may be drained through the filter bowl. Any individual tank may be drained by closing the selector valve and then draining the desired tank.

CAUTION

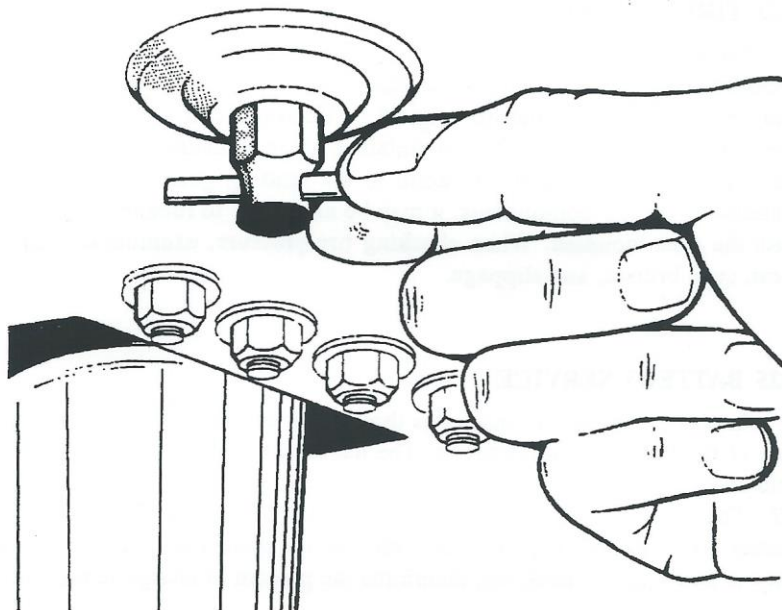
Whenever the fuel system is completely drained and fuel is replenished it will be necessary to run the engine for a minimum of three minutes at 1000 RPM on each tank to insure that no air exists in the fuel supply lines.

8.23 TIRE INFLATION

For maximum service from the tires, keep them inflated to the proper pressures - 18 psi for the nose gear and 24 psi for the main gear. All wheels and tires are balanced before original installation, and the relationship of tire, tube and wheel should be maintained upon reinstallation. Unbalanced wheels can cause extreme vibration in the landing gear; therefore, in the installation of new components, it may be necessary to rebalance the wheels with the tires mounted. When checking tire pressure, examine the tires for wear, cuts, bruises, and slippage.

8.25 BATTERY SERVICE

Access to the 24-volt battery is through an access panel at the right rear side of the baggage compartment. The battery box uses a sump jar to catch acid and a plastic tube which vents gases. This vent should never be closed off. The battery should be checked for proper fluid level. DO NOT fill the battery above the baffle plates. DO NOT fill the battery with acid - use water only. A hydrometer check will determine the percent of charge in the battery.

If the battery is not up to charge, recharge starting at a 3 amp rate and finishing with a 1 1/2 amp rate. Quick charges are not recommended.

NOTE:

Initial current reduced by 1/2 when all cells start gassing and charge voltage and specific gravity of electrolyte are constant over three successive readings taken at one hour intervals.

8.27 CLEANING

(a) Cleaning Engine Compartment

Before cleaning the engine compartment, place a strip of tape on the magneto vents to prevent any solvent from entering these units.

- (1) Place a large pan under the engine to catch waste.
- (2) With the engine cowling removed, spray or brush the engine with solvent or a mixture of solvent and degreaser. In order to remove especially heavy dirt and grease deposits, it may be necessary to brush areas that were sprayed.

CAUTION

Do not spray solvent into the alternator, vacuum pump, starter, or air intakes.

- (3) Allow the solvent to remain on the engine from five to ten minutes. Then rinse the engine clean with additional solvent and allow it to dry.

CAUTION

Do not operate the engine until excess solvent has evaporated or otherwise been removed.

- (4) Remove the protective tape from the magnetos.
- (5) Lubricate the controls, bearing surfaces, etc., in accordance with the Lubrication Chart.

(b) **Cleaning Landing Gear**

Before cleaning the landing gear, place a plastic cover or similar material over the wheel and brake assembly.

- (1) Place a pan under the gear to catch waste.
- (2) Spray or brush the gear area with solvent or a mixture of solvent and degreaser, as desired. Where heavy grease and dirt deposits have collected, it may be necessary to brush areas that were sprayed, in order to clean them.
- (3) Allow the solvent to remain on the gear from five to ten minutes. Then rinse the gear with additional solvent and allow to dry.
- (4) Remove the cover from the wheel and remove the catch pan.
- (5) Lubricate the gear in accordance with the Lubrication Chart.

(c) **Cleaning Exterior Surfaces**

The airplane should be washed with a mild soap and water. Harsh abrasives or alkaline soaps or detergents could make scratches on painted or plastic surfaces or could cause corrosion of metal. Cover areas where cleaning solution could cause damage. To wash the airplane, use the following procedure:

- (1) Flush away loose dirt with water.
- (2) Apply cleaning solution with a soft cloth, a sponge or soft bristle brush.
- (3) To remove exhaust stains, allow the solution to remain on the surface longer.
- (4) To remove stubborn oil and grease, use a cloth dampened with naphtha.
- (5) Rinse all surfaces thoroughly.
- (6) Any good automotive wax may be used to preserve painted surfaces. Soft cleaning cloths or a chamois should be used to prevent scratches when cleaning or polishing. A heavier coating of wax on the leading surfaces will reduce the abrasion problems in these areas.

(d) Cleaning Windshield and Windows

- (1) Remove dirt, mud and other loose particles from exterior surfaces with clean water.
- (2) Wash with mild soap and warm water or with aircraft plastic cleaner. Use a soft cloth or sponge in a straight back and forth motion. Do not rub harshly.
- (3) Remove oil and grease with a cloth moistened with kerosene.

CAUTION

Do not use gasoline, alcohol, benzene, carbon tetrachloride, thinner, acetone, or window cleaning sprays.

- (4) After cleaning plastic surfaces, apply a thin coat of hard polishing wax. Rub lightly with a soft cloth. Do not use a circular motion.
- (5) A severe scratch or mar in plastic can be removed by rubbing out the scratch with jeweler's rouge. Smooth both sides and apply wax.

(e) Cleaning Headliner, Side Panels and Seats

- (1) Clean headliner, side panels, and seats with a stiff bristle brush, and vacuum where necessary.
- (2) Soiled upholstery, except leather, may be cleaned with a good upholstery cleaner suitable for the material. Carefully follow the manufacturer's instructions. Avoid soaking or harsh rubbing.

CAUTION

Solvent cleaners require adequate ventilation.

- (3) Leather should be cleaned with saddle soap or a mild hand soap and water.

(f) **Cleaning Carpets**

To clean carpets, first remove loose dirt with a whisk broom or vacuum. For soiled spots and stubborn stains use a non-flammable dry cleaning fluid. Floor carpets may be removed and cleaned like any household carpet.

8.29 COLD WEATHER OPERATION

For cold weather operation a winterization plate is installed on the inlet opening of the oil cooler duct on the left rear engine baffle. This plate should be installed whenever the ambient temperature reaches 50°F or less. The plate should be removed and stored in the cockpit when the ambient temperature exceeds 50°F.

It is recommended that an optional Engine Breather Tube Winterization Kit be installed for cold weather operation. This kit is available through your Piper Dealer/Distributor.

TABLE OF CONTENTS

SECTION 9

SUPPLEMENTS

Paragraph No.		Page No.
9.1	General	9-1
1	Air Conditioning Installation	9-3
2	Bendix/King KAP 100 Series Flight Control System.....	9-7
3	Auxiliary Vacuum System	9-9 X
4	Bendix/King KLN 89 (B) GPS Navigation System.....(12 Pages)	9-15
5	Bendix/King KX 155A Comm/Nav System.....(12 Pages)	9-27
6	Bendix/King KAP 140 Series Flight Control System.....	9-39
7	Garmin GNS 430 Nav/Comm.....(8 Pages)	9-41 X
8	S-TEC System 55 Autopilot	9-49 X
9	S-TEC Manual Electric Trim System	9-51 X
10	BF Goodrich Skywatch Traffic Advisory System Model SKY497.....(6 Pages)	9-53
11	BF Goodrich WX-500 Stormscope Series II Weather Mapping Sensor.....(4 Pages)	9-59
12	Garmin GNS 430 Nav/Comm with Traffic Advisory and Lightning Strike Advisory Data	(8 Pages) 9-63
13	Garmin GTX 327 Transponder	(10 Pages) 9-71
14	S-TEC System 55X Autopilot.....	9-81
15	S-TEC ADF 650A System	(6 Pages) 9-83
16	Garmin GMA 340 Audio Panel	(6 Pages) 9-89
17	S-TEC DME 450.....	(4 Pages) 9-95
18	Garmin GTX 330 Transponder	(4 Pages) 9-99 X
19	Garmin GNS 530 Nav/Comm with Traffic Advisory and Lightning Strike Advisory Data	(8 Pages) 9-103
20	Avidyne FlightMax Entegra Primary Flight/Multi-Function Displays	(30 pages) 9-111
21	Mid-Continent 4300-4XX Series Electric Attitude Indicator	(4 pages) 9-139
22	S-TEC ADF-650D System	(10 pages) 9-143

TABLE OF CONTENTS

SECTION 9

SUPPLEMENTS

(continued)

Paragraph/Supplement No.		Page No.
23	Avidyne FlightMax Entegra Primary Flight/ Multi-Function Displays With The B&C Specialties BC410 Standby Alternator(36 pages)	9-153
24.	Bendix/King KR-87 Digital ADF with KI-227 Indicator(10 pages)	9-189
25.	Bendix/King KN-63 DME(4 pages)	9-199
26	Garmin G500 Primary Flight and Multifunction Display System(2 pages)	9-203
27.	Garmin GNS 430W VHF Communication Transceiver/VOR/ILS Receiver/GPS Receiver(12 pages)	9-205

SECTION 9

SUPPLEMENTS

9.1 GENERAL

This section provides information in the form of Supplements which are necessary for efficient operation of the airplane when equipped with one or more of the various optional systems and equipment not approved with the standard airplane.

All of the supplements provided in this section are FAA Approved and consecutively numbered as a permanent part of this Handbook. The information contained in each Supplement applies only when the related equipment is installed in the airplane.

THIS PAGE INTENTIONALLY LEFT BLANK

SUPPLEMENT 1

AIR CONDITIONING INSTALLATION

This supplement must be attached to the Pilot's Operating Handbook and FAA Approved Airplane Flight Manual when the optional air conditioning system is installed in accordance with Piper Drawing 99575-10. The information contained herein supplements or supersedes the Pilot's Operating Handbook and FAA Approved Airplane Flight Manual only in those areas listed herein. For limitations, procedures and performance information not contained in this supplement, consult the Pilot's Operating Handbook and FAA Approved Airplane Flight Manual.

This supplement has been "FAA Approved" as a permanent part of this handbook and must remain in this handbook at all times when the optional air conditioning system is installed.

FAA APPROVED: 

PETER E. PECK
D.O.A. NO. SO-1
THE NEW PIPER AIRCRAFT, INC.
VERO BEACH, FLORIDA

DATE OF APPROVAL: JULY 12, 1995

SECTION 1 - GENERAL

This supplement supplies information necessary for the efficient operation of the airplane when the optional air conditioning system is installed. The information contained within this supplement is to be used "as described" in conjunction with the complete handbook.

SECTION 2 - LIMITATIONS

- (a) To insure maximum climb performance the air conditioner must be turned OFF manually prior to takeoff to disengage the compressor and retract the condenser door. Also the air conditioner must be turned OFF manually before the landing approach in preparation for a possible go-around.

- (b) Placards

In full view of the pilot, in the area of the air conditioner controls when the air conditioner is installed:

“WARNING - AIR CONDITIONER MUST
BE OFF TO INSURE NORMAL TAKEOFF
CLIMB PERFORMANCE.”

In the annunciator cluster (condenser door light):

AIR COND DOOR

SECTION 3 - EMERGENCY PROCEDURES

No changes to the basic Emergency Procedures provided by SECTION 3 of this Pilot's Operating Handbook are necessary for this supplement.

SECTION 4 - NORMAL PROCEDURES

Prior to takeoff, the air conditioner should be checked for proper operation as follows:

- (a) Check aircraft master switch ON.
- (b) Turn the air conditioner control switch to ON and the fan switch to one of the operating positions - the "AIR COND DOOR" warning light will turn on, thereby indicating proper air conditioner condenser door actuation.
- (c) Turn the air conditioner control switch to OFF - the "AIR COND DOOR" warning light will go out, thereby indicating the air conditioner condenser door is in the up position.
- (d) If the "AIR COND DOOR" light does not respond as specified above, an air conditioner system or indicator bulb malfunction is indicated and further investigation should be conducted prior to flight.

The above operational check may be performed during flight if an in flight failure is suspected.

The condenser door light is located in the annunciator cluster in front of the pilot. The door light illuminates when the door is open and is off when the door is closed.

SECTION 5 - PERFORMANCE

Operation of the air conditioner will cause slight decreases in cruise speed and range. Power from the engine is required to run the compressor, and the condenser door, when extended, causes a slight increase in drag. When the air conditioner is turned off there is normally no measurable difference in climb, cruise or range performance of the airplane.

NOTE

To insure maximum climb performance the air conditioner must be turned off manually before takeoff to disengage the compressor and retract the condenser door. Also the air conditioner must be turned off manually before the landing approach in preparation for a possible go-around.

Although the cruise speed and range are only slightly affected by the air conditioner operation, these changes should be considered in preflight planning. To be conservative, the following figures assume that the compressor is operating continuously while the airplane is airborne. This will be the case only in extremely hot weather

- (a) The decrease in true airspeed is approximately 4 KTS at all power settings.
- (b) The decrease in range may be as much as 32 nautical miles for the 48 gallon capacity.

The climb performance is not compromised measurably with the air conditioner operating since the compressor is declutched and the condenser door is retracted, both automatically, when a full throttle position is selected. When the full throttle position is not used or in the event of a malfunction which would cause the compressor to operate and the condenser door to be extended, a decrease in rate of climb of as much as 100 fpm can be expected. Should a malfunction occur which prevents condenser door retraction when the compressor is turned off, a decrease in rate of climb of as much as 50 fpm can be expected.

SECTION 6 - WEIGHT AND BALANCE

Factory installed optional equipment is included in the licensed weight and balance data in Section 6 of the Pilot's Operating Handbook.

SECTION 7 - DESCRIPTION AND OPERATION

No change.

**PILOT'S OPERATING HANDBOOK
AND
FAA APPROVED AIRPLANE FLIGHT MANUAL**

**SUPPLEMENT NO. 2
FOR
KING KAP 100 SERIES FLIGHT CONTROL SYSTEM**

The FAA Approved Operational Supplement to the Bendix/King 100 Series Flight Control System as installed per STC SA1565CE-D is supplied by the autopilot manufacturer. Bendix/King will be responsible to supply and revise the operational supplement. It is permitted to include the Bendix/King supplement in this location of the Pilots Operating Handbook unless otherwise stated by Bendix/King. The information contained in the Bendix/King supplement may supersede or supplement the information in the basic Pilot's Operating Handbook and FAA Approved Airplane Flight Manual with respect to the operation of the autopilot. For limitations, procedures and performance information not contained in the Bendix/King supplement, consult the basic Pilot's Operating Handbook and FAA Approved Airplane Flight Manual.

THIS PAGE INTENTIONALLY LEFT BLANK

**PILOT'S OPERATING HANDBOOK
AND
FAA APPROVED AIRPLANE FLIGHT MANUAL**

**SUPPLEMENT NO. 3
FOR
AUXILIARY VACUUM SYSTEM**

This supplement must be attached to the Pilot's Operating Handbook and FAA Approved Airplane Flight Manual when the Piper Auxiliary Vacuum System is installed in accordance with Piper Drawing 85387-2. The information contained herein supplements or supersedes the Pilot's Operating Handbook and FAA Approved Airplane Flight Manual only in those areas listed herein. For limitations, procedures and performance information not contained in this supplement, consult the Pilot's Operating Handbook and FAA Approved Airplane Flight Manual.

FAA APPROVED:

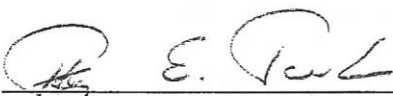

PETER E. PECK
D.O.A. NO. SO-1
THE NEW PIPER AIRCRAFT, INC.
VERO BEACH, FLORIDA

DATE OF APPROVAL: JULY 12, 1995

SECTION 1 - GENERAL

This supplement supplies information necessary for the operation of the airplane when the optional Piper Auxiliary Vacuum System is installed. The information contained within this supplement is to be used in conjunction with the complete handbook.

SECTION 2 - LIMITATIONS

1. The auxiliary vacuum system is limited to standby function only. Do not take off with the engine driven dry air pump inoperative.
2. Discontinue flight in Instrument Meteorological Conditions (IMC) if vacuum pressure falls below 4.8 In. Hg.
3. The auxiliary pump/motor assembly and elapsed time indicator must be removed from service after 500 hours accumulated operating time or 10 years, whichever occurs first.

SECTION 3 - EMERGENCY PROCEDURES

- (a) VAC OFF or Vacuum Inop. Warning - Auxiliary Vacuum Switch AUX ON.
- (b). Verify vacuum pressure of 4.8 to 5.2 inches of mercury.

CAUTION

Compass error may exceed 10 when auxiliary vacuum system is in operation.

- (c). Monitor electrical load - Verify alternator capacity is not being exceeded as indicated by the ammeter. If required, turn off nonessential electrical equipment.

SECTION 4 - NORMAL PROCEDURES

A. Preflight Check.

1. Turn on battery master switch on and verify that VAC OFF lamp lights.

NOTE

Due to electrical power requirement of the auxiliary vacuum pump it is suggested that the engine be operating while making the following checks.

2. Turn on auxiliary vacuum pump on and verify AUX ON light is illuminated and electrical load is approximately 15 amps on ammeter.
3. Turn off auxiliary vacuum pump and verify AUX ON light goes out.

B. Inflight Check - Prior to entering instrument flight conditions.

1. Turn off non-essential electrical equipment.
2. Turn on auxiliary vacuum pump and verify AUX ON light illuminated and electrical load is approximately 15 amps on ammeter.
3. Turn off auxiliary vacuum pump and verify AUX ON light goes out.

NOTE

For maximum service life, avoid continuous non-emergency operation of the auxiliary vacuum pump.

SECTION 5 - PERFORMANCE

No change.

SECTION 6 - WEIGHT & BALANCE

Factory installed optional equipment is included in the licensed weight and balance data in section 6 of the Pilot's Operating Handbook.

SECTION 7 - DESCRIPTION AND OPERATION

The auxiliary dry air pump system provides an independent back-up source of pneumatic power to operate the gyro flight instruments in the event the engine driven air pump fails.

The auxiliary pump is mounted on the forward side of the firewall and connects to the primary system at a manifold downstream of the vacuum regulator. Isolation of the primary and auxiliary systems from each other is accomplished by check valves on each side of the manifold. The primary system vacuum switch is located on the regulator and senses vacuum supplied to the gyros.

A control switch (labeled AUX VAC) for the auxiliary pump system is located on the right side of the instrument panel near the vacuum suction gage.

The switch button incorporates two annunciator light sections labeled VAC OFF and AUX ON. The VAC OFF section is controlled by a vacuum switch in the primary pneumatic system and illuminates an amber light when the engine driven pump is inoperative or when the system vacuum falls below the switch activation level. The AUX ON section is controlled by a vacuum switch on the manifold and illuminates a blue light when the auxiliary pump is operating and creating a vacuum in the system. When the auxiliary pump is activated at high altitude, or if the system has developed air leaks, the AUX ON light may fail to illuminate. This indicates that the system vacuum is still below the AUX ON switch activation level even though the auxiliary pump is operating. The annunciator lights do not incorporate a press-to-test feature, if the lights do not illuminate as expected, check for burned out lamps, replace with MS25237-327 bulbs and retest the system.

System electrical protection is provided by a 20 amp circuit breaker in the pump motor circuit and a 5 amp circuit breaker in the annunciator light circuit. The breakers are mounted on the circuit breaker panel.

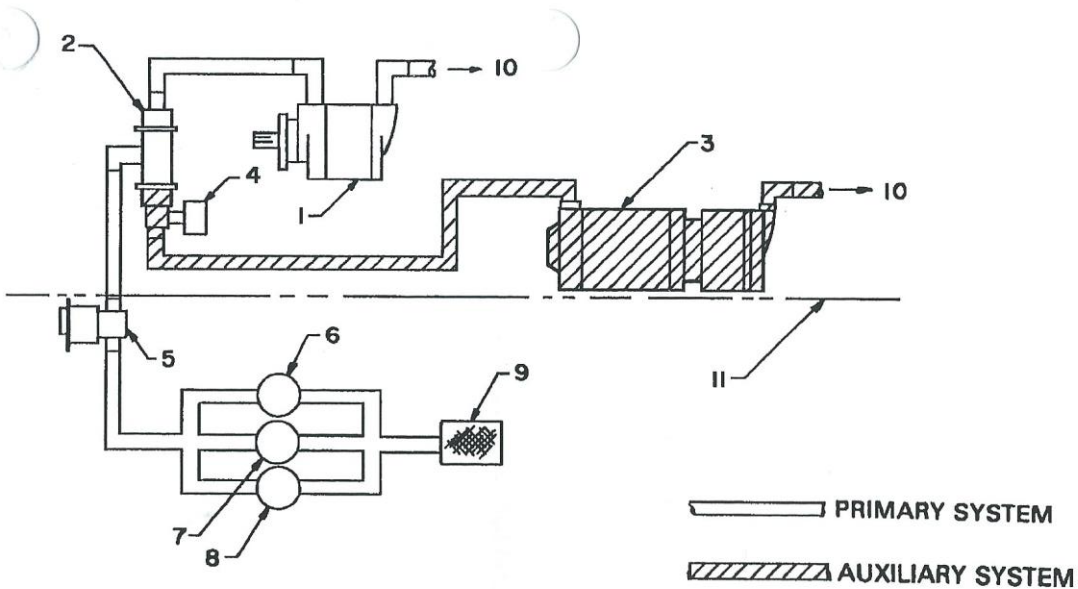

- 1. ENGINE DRIVEN DRY AIR PUMP
- 2. MANIFOLD & CHECK VALVE ASSY.
- 3. AUX. ELECTRICALLY DRIVEN DRY AIR PUMP
- 4. PRESSURE SENSING SWITCH
- 5. SYSTEM REGULATOR & PRESS. SENSING SWITCH
- 6. VACUUM (SUCTION) GAUGE

- 7. ATTITUDE GYRO
- 8. DIRECTIONAL GYRO
- 9. FILTER
- 10. OVERBOARD VENT
- 11. FIREWALL

THIS PAGE INTENTIONALLY LEFT BLANK

**PILOT'S OPERATING HANDBOOK
AND
FAA APPROVED AIRPLANE FLIGHT MANUAL**

**SUPPLEMENT NO. 4
FOR
BENDIX/KING KLN 89(B) GPS
NAVIGATION SYSTEM**

This supplement must be attached to the Pilot's Operating Handbook and FAA Approved Airplane Flight Manual when the KLN 89 (B) GPS Navigation System is installed per the Equipment List. The information contained herein supplements or supersedes the Pilot's Operating Handbook and FAA Approved Airplane Flight Manual only in those areas listed herein. For limitations, procedures and performance information not contained in this supplement, consult the Pilot's Operating Handbook and FAA Approved Airplane Flight Manual.

FAA APPROVED: 

PETER E. PECK
D.O.A. NO. SO-1
THE NEW PIPER AIRCRAFT, INC.
VERO BEACH, FLORIDA

DATE OF APPROVAL: APRIL 3, 1997

SECTION 1 GENERAL

NOTE

This supplement covers both the KLN 89 (VFR) only and the KLN 89B (IFR approved for Enroute, Terminal and non-precision approach phases of flight). There are numerous places throughout this supplement which discuss features and operational characteristics which specifically apply to KLN 89B and not to KLN 89. The parts of this supplement which apply to both the KLN 89 and the KLN 89B will be shown with a generic reference to KLN 89 (B).

The KLN 89(B) GPS panel mounted unit contains the GPS sensor, the navigation computer, a CRT display, and all controls required to operate the unit. It also houses the data base card which plugs directly into the front of the unit.

NOTE

SID's, STAR's and instrument approaches, apply only to the KLN 89B.

The data base card is an electronic memory containing information on airports, nav aids, intersections, SID's, STAR's, instrument approaches, special use airspace, and other items of value to the pilot.

Every 28 days, Bendix/King receives new data base information from Jeppesen Sanderson for the North American data base region. This information is processed and downloaded onto the data base cards. Bendix/King makes these data base card updates available to KLN 89(B) GPS users.

Provided the KLN 89(B) GPS navigation system is receiving adequate usable signals, it has been demonstrated capable of and has been shown to meet the accuracy specifications of:

SECTION 1 GENERAL (Cont'd)

VFR/IFR en route oceanic and remote, en route domestic, terminal, and instrument approach (GPS, VOR, VOR-DME, TACAN, NDB, NDB-DME, RNAV) operation within the U.S. National Airspace System, North Atlantic Minimum Navigation Performance Specifications (MNPS) Airspace and latitudes bounded by 74° North and 60° South using the WGS44 (or NAD 83) coordinate reference datum in accordance with the criteria of AC 20-138, AC 91-49, and AC 120-33. Navigation data is based upon use of only the global positioning system (GPS) operated by the United States.

NOTE

Aircraft using GPS for oceanic IFR operations may use the KLN 89B to replace one of the other approved means of long-range navigation. A single KLN 89B GPS installation may also be used on short oceanic routes which require only one means of longrange navigation.

NOTE

FAA approval of the KLN 89 (B) does not necessarily constitute approval for use in foreign airspace.

SECTION 2- LIMITATIONS

- A. The KLN 89 (B) GPS Pilot's Guide, P/N 006-08786-0000, dated May, 1995 (or later applicable revision) must be immediately available to the flight crew whenever navigation is predicated on the use of the system. The Operational Revision Status (ORS) of the Pilot's Guide must match the ORS level annunciated on the Self Test page.
- B. IFR Navigation is restricted as follows: (KLN 89B only.)
1. The system must utilize ORS level 01 or later FAA approved revision.
 2. The data on the self test page must be verified prior to use.
 3. IFR en route and terminal navigation is prohibited unless the pilot verifies the currency of the data base or verifies each selected waypoint for accuracy by reference to current approved data.
 4. Instrument approaches must be accomplished in accordance with approved instrument approach procedures that are retrieved from the KLN 89B data base. The KLN 89B data base must incorporate the current update cycle.
 - (a) The KLN 89B Quick Reference, P/N 006-08787-0000, dated 5/95 (or later applicable revision) must be immediately available to the flight crew during instrument approach operations.
 - (b) Instrument approaches must be conducted in the approach mode and RAIM must be available at the Final Approach Fix.
 - (c) APR ACTV mode must be annunciated at the Final Approach Fix.
 - (d) Accomplishment of ILS, LOC, LOC-BC, LDA, SDF, and MLS approaches are not authorized.
 - (e) When an alternate airport is required by the applicable operating rules, it must be served by an approach based on other than GPS or Loran-C navigation.
 - (f) The KLN 89B can only be used for approach guidance if the reference coordinate datum system for the instrument approach is WGS 84 or NAD-83. (All approaches in the KLN 89 (B) data base use the WGS-84 or the NAD-83 geodetic datums.)
 5. The aircraft must have other approved navigation equipment appropriate to the route of flight installed and operational.

**SECTION 3- EMERGENCY PROCEDURES
ABNORMAL PROCEDURES**

- A. If the KLN 89 (B) GPS information is not available or invalid, utilize remaining operational navigation equipment as required.
- B. If a "RAIM NOT AVAILABLE" message is displayed while conducting an instrument approach, terminate the approach. Execute a missed approach if required.
- C. If a "RAIM NOT AVAILABLE" message is displayed in the en route or terminal phase of flight, continue to navigate using the KLN 89B or revert to an alternate means of navigation appropriate to the route and phase of flight. When continuing to use GPS navigation, position must be verified every 15 minutes using another IFR approved navigation system.
- D. Refer to the KLN 89 (B) Pilot's Guide, Appendices B and C, for appropriate pilot actions to be accomplished in response to annunciated messages.

SECTION 4 - NORMAL PROCEDURES**WARNING**

Familiarity with the en route operation of the KLN 89 (B) does not constitute proficiency in approach operations. Do not attempt approach operations in IMC prior to attaining proficiency in the use of the KLN 89 (B).

A. OPERATION

Normal operating procedures are outlined in the KLN 89 (B) GPS Pilot's Guide, P/N 006-08786-0000, dated May 1995, (or later applicable revision). A KLN 89 (B) Quick Reference, P/N 006-08787-0000 dated 5/95 (or later applicable revision) containing an approach sequence, operating tips and approach related messages is intended for cockpit use by the KLN 89B familiar pilot when conducting instrument approaches.

B. SYSTEM ANNUNCIATORS/SWITCHES/CONTROLS

1. HSI NAV presentation (NAV/GPS) switch annunciator- May be used to select data for presentation on the pilot's HSI; either NAV data from the number one navigation receiver or GPS data from the KLN 89 (B) GPS. Presentation on the HSI is also required for autopilot coupling. NAV is green. GPS is blue.

NORMAL PROCEDURES

2. Message (MSG) annunciator - Will flash to alert the pilot of a situation that requires attention. Press the MSG button on the KLN 89 (B) GPS to view the message. (Appendix B of the KLN 89 (B) Pilot's Guide contains a list of all of the message page messages and their meanings). MSG is amber.
3. Waypoint (WPT) annunciator - Prior to reaching a waypoint in the active flight plan, the KLN 89 (B) GPS will provide navigation along a curved path segment to ensure a smooth transition between two adjacent legs in the flight plan. This feature is called turn anticipation. Approximately 20 seconds prior to the beginning of turn anticipation the WPT annunciator will flash, going solid upon initialization of the turn, and extinguishing upon turn completion. WPT is amber.

WARNING

Turn anticipation is automatically disabled for FAF waypoints and those used exclusively in SID/STARS where overflight is required. For waypoints shared between SID/STARS and published en route segments (requiring overflight in the SID/ STARS), proper selection on the presented waypoint page is necessary to provide adequate route protection on the SID/STARS.

4. HSI course control ① knob - Provides analog course input to the KLN 89 (B) in OBS when the NAV/GPS switch/annunciator is in GPS. When the NAV/GPS switch annunciation is in NAV, GPS course selection in OBS mode is digital through the use of the controls and display at the KLN 89 (B). The HSI course control knob must also be set to provide proper course datum to the autopilot if coupled to the KLN 89 (B) in LEG or OBS.

NOTE

Manual HSI course centering in OBS using the control knob can be difficult, especially at long distances. Centering the dbar can best be accomplished by pressing  and then manually setting the HSI pointer to the course value prescribed in the KLN 89 (B) displayed message.

NORMAL PROCEDURES

5. GPS approach (GPS APR ARM/ACTV) switch/annunciator - (KLN 89B only) used to (a) manually select or deselect approach ARM (or deselect approach ACTV) and (b) annunciate the stage of approach operation either armed (ARM) or activated (ACTV). Sequential button pushes if in ACTV would first result in approach ARM and then approach arm canceled. Subsequent button pushes will cycle between the armed state (if an approach is in the flight plan) and approach arm canceled. Approach ACTV cannot be selected manually. GPS APR and ARM are white. ACTV is green.
6. RMI NAV presentation switch - May be used to select data for presentation on the RMI; either NAV 1 data from the number one navigation receiver, NAV 2 data from the number two navigation receiver or GPS data from the KLN 89 (B) GPS.

C. PILOTS DISPLAY

Left/right steering information is presented on the pilot's HSI as a function of the NAV/GPS switch position.

D. AUTOPILOT COUPLED OPERATION

The KLN 89 (B) may be coupled to the autopilot by first selecting GPS on the NAV/GPS switch. Manual selection of the desired track on the pilot's HSI course pointer is required to provide course datum to the autopilot. (Frequent manual course pointer changes may be necessary, such as in the case of flying a DME arc.) The autopilot approach mode (APR) should be used when conducting a coupled GPS approach.

NOTE

Select HDG mode for DME arc intercepts. NAV or APR coupled DME arc intercepts can result in excessive overshoots (aggravated by high ground speeds and/or intercepts from inside the arc).

NORMAL PROCEDURES

E. ALTITUDE ALERT AURAL TONES

- 1000 feet prior to reaching the selected altitude - three short tones.
- Upon reaching the selected altitude - two short tones.
- Deviating above or below the selected altitude by more than the warn altitude - four short tones.

F. APPROACH MODE SEQUENCING AND RAIM PREDICTION
(KLN 89B only.)

NOTE

The special use airspace alert will automatically be disabled prior to flying an instrument approach to reduce the potential for message congestion.

1. Prior to arrival, select a STAR if appropriate from the **APT 7** page. Select an approach and an initial approach fix (IAF) from the **APT 8** page.

NOTES

- Using the outer knob, select the **ACT** (Active Flight Plan Waypoints) pages. Pull the inner knob out and scroll to the destination airport, then push the inner knob in and select the **ACT 7** or **ACT 8** page.
 - To delete or replace a **SID**, **STAR** or approach, select **FPL 0** page. Place the cursor over the name of the procedure, press **ENT** to change it, or **CLR** then **ENT** to delete it.
2. En route, check for **RAIM** availability at the destination airport **ETA** on the **OTH 3** page.

NOTE

RAIM must be available at the **FAF** in order to fly an instrument approach. Be prepared to terminate the approach upon loss of **RAIM**.

NORMAL PROCEDURES

3. At 30 nm from the airport:
 - a. Verify automatic annunciation of APR ARM.
 - b. Note automatic dbar scaling change from ± 5.0 nm to ± 1.0 nm over the next 30 seconds.
 - c. Update the KLN 89B altimeter baro setting as required.
 - d. Internally the KLN 89B will transition from en route to terminal integrity monitoring.
4. Select NAV 4 page to fly the approach procedure.
 - a. If receiving radar vectors, or need to fly a procedure turn or holding pattern, fly in OBS until inbound to the FAF.

NOTE

OBS navigation is TO-FROM (like a VOR) without waypoint sequencing.

- b. NoPT routes including DME arc's are flown in LEG. LEG is mandatory from the FAF to the MAP.

NOTE

Select HDG mode for DME arc intercepts. NAV or APR coupled DME arc intercepts can result in excessive overshoots (aggravated by high ground speeds and/or intercepts from inside the arc).

WARNING

Flying final outbound from an off airport vortac on an overlay approach; beware of the DME distance increasing on final approach, and the GPS distance-to waypoint decreasing, and not matching the numbers on the approach plate!

5. At or before 2 nm from the FAF inbound:
 - a. Select the FAF as the active waypoint, if not accomplished already.
 - b. Select LEG operation.

NORMAL PROCEDURES

6. Approaching the FAF inbound (within 2 nm.):
 - a. Verify APR ACTV.
 - b. Note automatic dbar scaling change from ± 1.0 nm to ± 0.3 nm over the 2 nm inbound to the FAF.
 - c. Internally the KLN 89B will transition from terminal to approach integrity monitoring.
7. Crossing the FAF and APR ACTV is not annunciated:
 - a. Do not descend.
 - b. Execute the missed approach.
8. Missed Approach:
 - a. Climb
 - b. Navigate to the MAP (in APR ARM if APR ACTV is not available).

NOTE

There is no automatic LEG sequencing at the MAP.

- c. After climbing in accordance with the published missed approach procedure, press  verify or change the desired holding fix and press ENT.

GENERAL NOTES

- The data base must be up to date for instrument approach operation.
- Only one approach can be in the flight plan at a time.
- If the destination airport is the active waypoint at the time of the instrument approach selection, the active waypoint will shift automatically to the chosen IAF.
- Checking RAIM prediction for your approach while en route using the **OTH 3** page is recommended. A self check occurs automatically within 2 nm of the FAF. APR ACTV is inhibited without RAIM.
- Data cannot be altered, added to or deleted from the approach procedures contained in the data base. (DME arc intercepts may be relocated along the arc through the NAV4 or the FPL 0 pages).
- Some approach waypoints do not appear on the approach plates (including in some instances the FAF)!

NORMAL PROCEDURES

- Waypoint suffixes in the flight plan:
 - i - IAF
 - f - FAF
 - m - MAP
 - h missed approach holding fix.
- The DME arc IAF (arc intercept waypoint) will be a) on your present position radial off the arc VOR when you load the IAF into the flight plan, or b) the beginning of the arc if currently on a radial beyond the arc limit. To adjust the arc intercept to be compatible with a current radar vector, bring up the arc IAF waypoint in the NAV 4 page scanning field or under the cursor on the FPL 0 page, press CLR, then ENT. Fly the arc in LEG. adjust the HSI or CDI course pointer with reference to the desired track value on the NAV 4 page (it will flash to remind you). Left/right dbar information is relative to the arc. Displayed distance is not along the arc but direct to the active waypoint. (The ARC radial is also displayed in the lower right corner of the NAV 4 page.)
- The DME arc IAF identifier may be unfamiliar. Example: D098G where 098 stands for the 098° radial off the referenced VOR, and G is the seventh letter in the alphabet indicating a 7 DME arc.

NORMAL PROCEDURES

- APR ARM to APR ACTV is automatic provided:
 - a. You are in APR ARM (normally automatic).
 - b. You are in LEG mode!
 - c. The FAF is the active waypoint!
 - d. Within 2 n.m. of the FAF.
 - e. Outside of the FAF.
 - f. Inbound to the FAF.
 - g. RAIM is available.
- Direct-To operation between the FAF and MAP cancels APR ACTV. Fly the missed approach in APR ARM.
- Flagged navigation inside the FAF may usually be restored (not guaranteed) by pressing the GPS APR button changing from ACTV to ARM. Fly the missed approach.
- The instrument approach using the KLN 89 (B) may be essentially automatic starting 30 nm out (with a manual baro setting update) or it may require judicious selection of the OBS and LEG modes.
- APR ARM may be canceled at any Time by pressing the GPS APR button. (A subsequent press will reselect it.)

SECTION 5- PERFORMANCE

No change.

SECTION 6- WEIGHT AND BALANCE

Factory installed optional equipment is included in the licensed weight and balance data in Section 6 of the Basic Pilot's Operating HANdbook.

**PILOT'S OPERATING HANDBOOK
AND
FAA APPROVED AIRPLANE FLIGHT MANUAL**

**SUPPLEMENT NO. 5
FOR
BENDIX/KING KX 155A
COMM/NAV SYSTEM**

This supplement must be attached to the Pilot's Operating Handbook and FAA Approved Airplane Flight Manual when the KX 155A Comm/Nav System is installed per the Piper Drawings. The information contained herein supplements or supersedes the Pilot's Operating Handbook and FAA Approved Airplane Flight Manual only in those areas listed herein. For limitations, procedures and performance information not contained in this supplement, consult the Pilot's Operating Handbook and FAA Approved Airplane Flight Manual.

FAA APPROVED: 

PETER E. PECK
D.O.A. NO. SO-1
THE NEW PIPER AIRCRAFT, INC.
VERO BEACH, FLORIDA

DATE OF APPROVAL: APRIL 3, 1997

SECTION 1 GENERAL

This supplement supplies information necessary for the operation of the airplane when the Bendix/King KX 155A Comm/Nav System is installed in accordance with FAA approved Piper data.

SECTION 2 LIMITATIONS

No change.

SECTION 3- EMERGENCY PROCEDURES

No change.

SECTION 4- NORMAL PROCEDURES

COMM TRANSCEIVER

- (a.) Rotate the volume (VOL) knob clockwise from the OFF position.
- (b.) Pull the VOL knob out and adjust for desired listening level.
- (c.) Push the VOL knob back in to actuate the automatic squelch.
- (d.) Select the desired operating frequency in the standby display by rotating the frequency select knobs either clockwise or counter-clockwise.
- (e.) Push the comm transfer button to transfer the frequency from the standby to the active display.

NAV RECEIVER

- (a.) The right portion of the display is allocated to NAV receiver information. The frequency channeling is similar to the Comm when operating in the frequency mode. The NAV increment/decrement knobs are located on the right hand side of the front panel.

SECTION 5- PERFORMANCE

No change.

SECTION 6- WEIGHT AND BALANCE

See Section 6 of the basic Pilots Operating Handbook.

SECTION 7 DESCRIPTION & OPERATION

GENERAL

All controls required to operate the KX 155A are located on the unit front panel. (See Figure 3-1.)

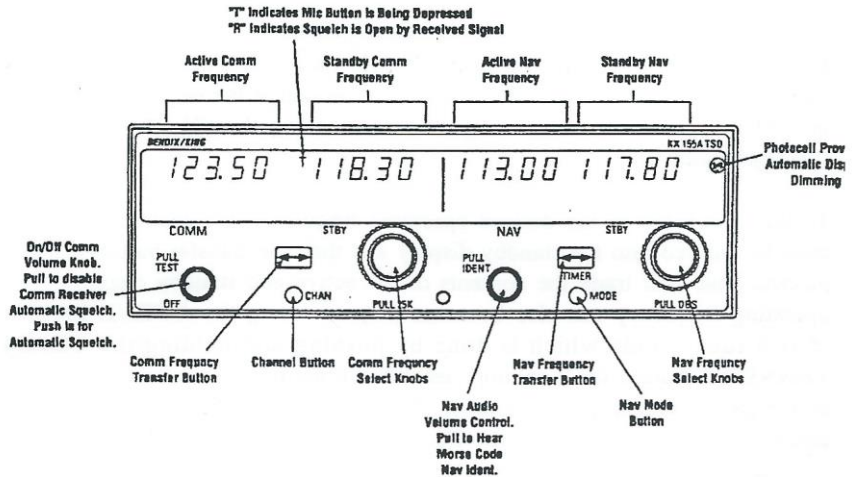

FIGURE 3-1
KX 155A CONTROL FUNCTIONS

COMM TRANSCEIVER

Rotate the VOL knob clockwise from the OFF position. Pull the VOL knob out and adjust for desired listening level. Push the VOL knob back in to actuate the automatic squelch.

The left portion of the digital display readout is allocated for COMM ACTIVE, and COMM STANDBY frequencies with a "T" between them to indicate TRANSMIT and an "R" to indicate RECEIVE modes of operation.

Select the desired operating frequency in the standby display by rotating the Frequency Select Knobs either clockwise or counter-clockwise. A clockwise rotation will increment the previous frequency while a counterclockwise rotation will decrement the previous frequency.

COMM TRANSCEIVER (CONT'D)

The outer knob will change the MHz portion of the standby display. At one band-edge (118 or 136 MHz) the following 1 MHz change will wrap around to the other band-edge. The inner knob will change the kHz portion of the standby display. It will change in steps of 50 kHz when the knob is pushed in, and 25 kHz when the knob is pulled out. For 8.33 kHz versions, channels are incremented in 25 kHz steps with the knob pushed in and 8.33 kHz with the knob pulled out. (Both 8.33 kHz and 25 kHz frequencies are channeled when the knob is pulled out). The frequency wrap around at the edge of the band is also utilized when incrementing or decrementing the kHz portion of the standby display.

To tune the radio to the desired operating frequency, the desired frequency must be entered into the standby display and then the transfer button must be pushed. This will trade the contents of the active and standby displays. The operating frequency can also be entered by accessing the ACTIVE ENTRY (direct tune) mode which is done by pushing and holding the COMM TRANSFER button for 2 or more seconds. In the direct tune mode, only the active part of the display is visible. The desired frequency can be directly entered into the display. Push the COMM TRANSFER button again to return to the active/standby display.

The transceiver is always tuned to the frequency appearing in the ACTIVE display. It is therefore possible to have two different frequencies stored in the ACTIVE and STANDBY displays and to change back and forth between them at the simple push of the transfer button.

During the transmit mode of operation, a "T" will appear between the ACTIVE and STANDBY displays. An "R" will appear between the ACTIVE and STANDBY displays if a detected signal is strong enough to open the squelch, signifying that the transceiver is in the receive mode of operation.

A non-volatile memory stores the comm ACTIVE and STANDBY frequencies on power down. When the unit is turned on again, the COMM ACTIVE and STANDBY windows will display the same ACTIVE and STANDBY frequencies that were displayed before power down.

The KX 155A also has provision to program 32 channels. Pressing the CHAN button for 2 or more seconds will cause the unit to enter the channel program mode. Upon entering the channel program mode, "PG" is displayed next to the channel number and the channel number will flash indicating that it can be programmed. The desired channel can be selected by turning the comm kHz knob. The channel frequency can be entered by pushing the COMM TRANSFER button which will cause the standby frequency to flash. The comm frequency knobs are then used to enter the desired frequency. If dashes (displayed when rotating the outer knob between 136 MHz and 118 MHz) are entered instead of a frequency, the corresponding channel is skipped in channel selection mode. Additional channels may be programmed by pressing the COMM TRANSFER and using the same procedure. To exit the program mode and save the channel information, momentarily push the CHAN button. This will cause the unit to return to the previous frequency entry mode. The unit will also exit the channel program mode if there is no button or knob activity for 20 seconds.

The channel selection mode can then be entered by momentarily pushing CHAN button. "CH" is displayed next to the last used channel number. The comm frequency knobs can be used to select the desired channel. The unit will automatically default to the previous mode if no channel is selected within 2 seconds after entering the channel selection mode.

The unit is placed in the transmit mode by depressing the MIC KEY button. The unit has a stuck microphone alert feature. If the microphone is keyed continuously for greater than 33 seconds, the transmitter stops transmitting and the active Comm frequency flashes to alert the pilot of the stuck microphone condition.

NAV RECEIVER

The right portion of the display is allocated to NAV receiver information. The frequency channeling is similar to the COMM when operating in the frequency mode (Figure 3-1). The NAV increment/decrement knobs are located on the right hand side of the front panel. The outer knob operates in 1 MHz steps and increments/decrements the STANDBY frequency display.

NAV RECEIVER (CONT'D)

The inner knob operates in 50 kHz steps. The NAV receiver's lower and upper frequency limits are 108.00 MHz and 117.95 MHz. Exceeding the upper limit of frequency band will automatically return to the lower limit and vice versa.

Depressing the NAV frequency transfer button for 2 seconds or more will cause the display to go in to the ACTIVE ENTRY mode. Only the ACTIVE frequency will be displayed and it can be directly changed by using the NAV inc/dec knobs. The display will return to the ACTIVE/STANDBY mode when the NAV frequency transfer button is pushed.

Depressing the mode button will cause the NAV display to go from the ACTIVE/STANDBY format to the ACTIVE/CDI (Course Deviation Indicator) format as shown below in Figure 3-2. In the CDI mode, the increment/decrement knob (pushed in) channels the ACTIVE frequency window and depressing the frequency transfer button will cause the ACTIVE frequency to be placed in blind storage and the STANDBY frequency (in blind storage) to be displayed in the ACTIVE window display. When the ACTIVE window is tuned to a VOR frequency, the standby frequency area is replaced by a three digit OBS (Omni Bearing Selector) display. The desired OBS course can be selected by pulling out the inner NAV frequency knob and turning it. This OBS display is independent of any OBS course selected on an external CDI or HSI. An "OBS" in the middle of the NAV display will flash while the inner NAV frequency knob is pulled out. The CDI is displayed on the line below the frequency/OBS. When the ACTIVE window is tuned to a localizer frequency, the standby frequency area is replaced by "LOC" Figure 3-3. Illustrations of the display are shown on the next page.

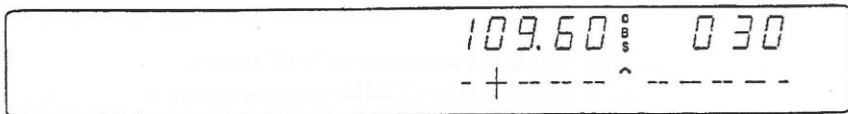

FIGURE 3-2
NAV DISPLAY; ACTIVE VOR FREQUENCY/CDI FORMAT

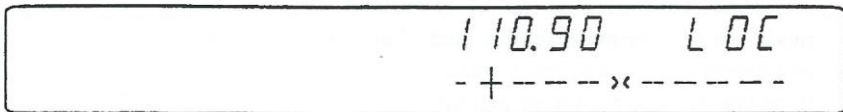

FIGURE 3-3
NAV DISPLAY; ACTIVE LOCALIZER FREQUENCY/CDI FORMAT

When the received signal is too weak to ensure accuracy the display will "flag". See Figure 3-4.

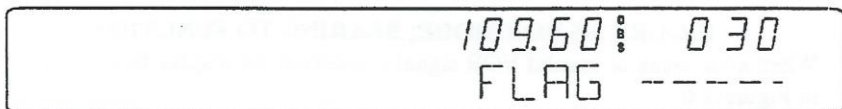

FIGURE 3-4 VOR FLAG DISPLAY

NAV RECEIVER (CONT'D)

Depressing the mode button will cause the NAV display to go from the ACTIVE/CDI format to the ACTIVE/BEARING format. In the BEARING mode, the increment/decrement knob channels the ACTIVE frequency window and depressing the frequency transfer button will cause the ACTIVE frequency to be placed in blind storage and the STANDBY frequency (in blind storage) to be displayed in the ACTIVE window display. In bearing mode of operation, the right hand window of NAV display shows the bearing TO the station. Figure 3-5 below illustrates the NAV side of the display in this mode:

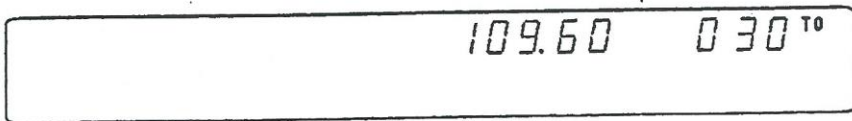

FIGURE 3-5 VOR MODE; BEARING TO FUNCTION

When a too weak or invalid VOR signal is received the display flags as shown in Figure 3-6.

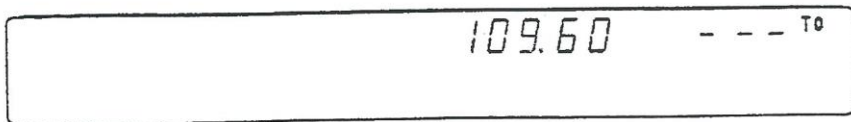

FIGURE 3-6 VOR MODE; ACTIVE/BEARING, FLAG DISPLAY

Another push of the mode button will cause the NAV display to go from the ACTIVE/BEARING format to the ACTIVE/RADIAL format as shown in Figure 3-7. In the RADIAL mode, the increment/decrement knob channels the ACTIVE frequency window and depressing the frequency transfer button will cause the ACTIVE frequency to be placed in blind storage and the STANDBY frequency (in blind storage) to be displayed in the ACTIVE window display. In radial mode of operation, the right hand window of NAV display shows the radial FROM the station. The picture below illustrates the NAV side of the display in this mode:

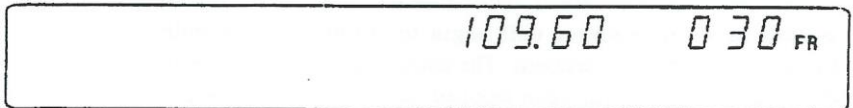

FIGURE 3-7 VOR MODE; RADIAL FROM FUNCTION

When a too weak or invalid VOR signal is received the display flags as shown in Figure 3-8.

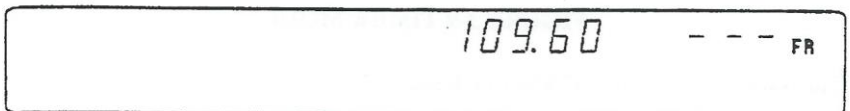

FIGURE 3-8 VOR MODE; ACTIVE/RADIAL, FLAG DISPLAY

NAV RECEIVER (CONT'D)

Another push of the mode button will cause the unit to go into the TIMER mode. See Figure 3-9. When the unit is turned on the elapsed timer begins counting upwards from zero. The timer can be stopped and reset to zero by pushing the NAV frequency transfer button for 2 seconds or more causing the ET on the display to flash. In this state the timer can be set as a countdown timer or the elapsed timer can be restarted. The countdown timer is set by using the NAV inc/dec knobs to set the desired time and then pushing the NAV frequency transfer button to start the timer. The outer knob selects minutes, the inner knob in the "in ~ position selects ten second intervals, and the inner knob in the ~out" position selects individual seconds. After the countdown timer reaches zero, the counter will begin to count upwards indefinitely while flashing for the first 15 seconds. The elapsed timer can also be reset to zero and started again after it has been stopped and reset to zero by pushing the NAV frequency transfer button.

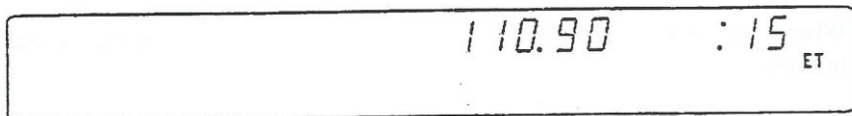

FIGURE 3-9 TIMER MODE

The NAV ACTIVE and STANDBY frequencies are stored in the memory on power down and return on power up.

When the smaller increment/decrement knob is pushed in, depressing the NAV TRANSFER button will interchange the ACTIVE and STANDBY frequencies. The NAV IDENT knob is active in the pulled out position so that both voice and ident can be heard. When this knob is pushed in, the ident tone is attenuated. The volume of voice/ident can be adjusted by turning this knob.

PILOT CONFIGURATION

This mode can be accessed by pressing and holding the Nav Mode Button for more than 2 seconds and then pressing the Nav Frequency Transfer Button for an additional 2 seconds, while continuing to hold the Nav Mode Button. When the Pilot Config Mode is entered the unit will show the "SWRV" mnemonic which is the unit software revision level. Adjustment pages can be accessed by MODE button presses.

The pilot may adjust two parameters in the pilot configuration, the display minimum brightness and sidetone volume level. See Table 3-1.

Minimum Brightness (BRIM) will have a range of 0 - 255. The dimmest is 0 and the brightest is 255.

Sidetone volume level is adjusted when SIDE is displayed. Values from 0 - 255 may be selected with 0 being least volume, 255 being the greatest.

Adjustment	Mnemonic	Min Level	Max Level
Software Revision Number	SWRV	--	--
Minimum Display Brightness	BRIM	0	255
Sidetone Level	SIDE	0	255

Table 3-1 Pilot Configuration

Subsequent presses of the MODE button sequences through SWRV, BRIM, SIDE, and then back to SWRV.

Momentarily pressing the Nav Transfer Button exits Pilot configuration mode. The Nav returns to its pre-Pilot Config state with the new brightness and sidetone levels stored in non-volatile memory.

THIS PAGE INTENTIONALLY LEFT BLANK

**PILOT'S OPERATING HANDBOOK
AND
FAA APPROVED AIRPLANE FLIGHT MANUAL

SUPPLEMENT NO. 6
FOR
KING KAP 140 SERIES FLIGHT CONTROL SYSTEM**

The FAA Approved Operational Supplement to the Bendix/King 100 Series Flight Control System as installed per STC SA00444WI-D is supplied by the autopilot manufacturer. Bendix/King will be responsible to supply and revise the operational supplement. It is permitted to include the Bendix/King supplement in this location of the Pilots Operating Handbook unless otherwise stated by Bendix/King. The information contained in the Bendix/King supplement may supersede or supplement the information in the basic Pilot's Operating Handbook and FAA Approved Airplane Flight Manual with respect to the operation of the autopilot. For limitations, procedures and performance information not contained in the Bendix/King supplement, consult the basic Pilot's Operating Handbook and FAA Approved Airplane Flight Manual.

THIS PAGE INTENTIONALLY LEFT BLANK

**PILOT'S OPERATING HANDBOOK
AND
FAA APPROVED AIRPLANE FLIGHT MANUAL**

**SUPPLEMENT NO. 7
FOR
GARMIN GNS 430 VHF COMMUNICATION
TRANSCEIVER/VOR/ILS RECEIVER/GPS RECEIVER**

This supplement must be attached to the Pilot's Operating Handbook and FAA Approved Airplane Flight Manual when the Garmin GNS 430 VHF Communication Transceiver/VOR/ILS Receiver/Global Positioning System is installed per the Equipment List. The information contained herein supplements or supersedes the Pilot's Operating Handbook and FAA Approved Airplane Flight Manual only in those areas listed herein. For limitations, procedures and performance information not contained in this supplement, consult the Pilot's Operating Handbook and FAA Approved Airplane Flight Manual.

FAA APPROVED:



PETER E. PECK

D.O.A. NO. SO-1

THE NEW PIPER AIRCRAFT, INC.

VERO BEACH, FLORIDA

DATE OF APPROVAL: NOVEMBER 6, 1998

SECTION 1 - GENERAL

The GNS 430 System is a fully integrated, panel mounted instrument, which contains a VHF Communications Transceiver, a VOR/ILS receiver, and a Global Positioning System (GPS) Navigation computer. The system consists of a GPS antenna, GPS receiver, VHF VOR/LOC/GS antenna, VOR/ILS receiver, VHF COMM antenna and a VHF Communications transceiver. The primary function of the VHF Communication portion of the equipment is to facilitate communication with Air Traffic Control. The primary function of the VOR/ILS Receiver portion of the equipment is to receive and demodulate VOR, Localizer, and Glide Slope signals. The primary function of the GPS portion of the system is to acquire signals from the GPS system satellites, recover orbital data, make range and Doppler measurements, and process this information in real-time to obtain the user's position, velocity, and time.

Provided the GARMIN GNS 430's GPS receiver is receiving adequate usable signals, it has been demonstrated capable of and has been shown to meet the accuracy specifications for:

VFR/IFR enroute, terminal, and non-precision instrument approach (GPS, Loran-C, VOR, VOR-DME, TACAN, NDB, NDB-DME, RNAV) operation within the U.S. National Airspace System in accordance with AC 20-138.

North Atlantic Minimum Navigation Performance Specification (MNPS) Airspace in accordance with AC 91-49 and AC 120-33.

Navigation is accomplished using the WGS-84 (NAD-83) coordinate reference datum. Navigation data is based upon use of only the Global Positioning System (GPS) operated by the United States of America.

SECTION 2 - LIMITATIONS

- A. The GARMIN GNS 430 Pilot's Guide, p/n 190-00140-00, Rev. A, dated October 1998, or later appropriate revision, must be immediately available to the flight crew whenever navigation is predicated on the use of the system.
- B. The GNS 430 must utilize the following or later FAA approved software versions:

Sub-System	Software Version
Main	2.00
GPS	2.00
COMM	2.00
VOR/LOC	2.00
G/S	2.00

The main software version is displayed on the GNS 430 self test page immediately after turn-on for 5 seconds. The remaining system software versions can be verified on the AUX group sub-page 2, "SOFTWARE/DATABASE VER".

- C. IFR enroute and terminal navigation predicated upon the GNS 430's GPS Receiver is prohibited unless the pilot verifies the currency of the data base or verifies each selected waypoint for accuracy by reference to current approved data.
- D. Instrument approach navigation predicated upon the GNS 430's GPS Receiver must be accomplished in accordance with approved instrument approach procedures that are retrieved from the GPS equipment data base. The GPS equipment data base must incorporate the current update cycle.
1. Instrument approaches utilizing the GPS receiver must be conducted in the approach mode and Receiver Autonomous Integrity Monitoring (RAIM) must be available at the Final Approach Fix.

SECTION 2 - LIMITATIONS (continued)

2. Accomplishment of ILS, LOC, LOC-BC, LDA, SDF, MLS or any other type of approach not approved for GPS overlay with the GNS 430's GPS receiver is not authorized.
 3. Use of the GNS 430 VOR/ILS receiver to fly approaches not approved for GPS require VOR/ILS navigation data to be present on the external indicator.
 4. When an alternate airport is required by the applicable operating rules, it must be served by an approach based on other than GPS or Loran-C navigation, the aircraft must have the operational equipment capable of using that navigation aid, and the required navigation aid must be operational.
 5. VNAV information may be utilized for advisory information only. Use of VNAV information for Instrument Approach Procedures does not guarantee Step-Down Fix altitude protection, or arrival at approach minimums in normal position to land.
- E. If not previously defined, the following default settings must be made in the "SETUP 1" menu of the GNS 430 prior to operation (refer to Pilot's Guide for procedure if necessary):
1. dis, spd..... $\frac{n}{m}$ k_t (sets navigation units to "nautical miles" and "knots")
 2. alt, vs..... f_t fpm (sets altitude units to "feet" and "feet per minute")
 3. map datum..WGS 84 (sets map datum to WGS-84, see not below)
 4. posn.....deg-min (sets navigation grid units to decimal minutes)

NOTE

In some areas outside the United States, datums other than WGS-84 or NAD-83 may be used. If the GNS 430 is authorized for use by the appropriate Airworthiness authority, the required geodetic datum must be set in the GNS 430 prior to its use for navigation.

SECTION 3 - EMERGENCY PROCEDURES**ABNORMAL PROCEDURES**

- A. If GARMIN GNS 430 navigation information is not available or invalid, utilize remaining operational navigation equipment as required.
- B. If "RAIM POSITION WARNING" message is displayed the system will flag and no longer provide GPS based navigational guidance. The crew should revert to the GNS 430 VOR/ILS receiver or an alternate means of navigation other than the GNS 430's GPS receiver.
- C. If "RAIM IS NOT AVAILABLE" message is displayed in the enroute, terminal, or initial approach phase of flight, continue to navigate using the GPS equipment or revert to an alternate means of navigation other than the GNS 430's GPS receiver appropriate to the route and phase of flight. When continuing to use GPS navigation, position must be verified every 15 minutes using the GNS 430's VOR/ILS receiver or another IFR-approved navigation system.
- D. If "RAIM IS NOT AVAILABLE" message is displayed while on the final approach segment, GPS based navigation will continue for up to 5 minutes with approach CDI sensitivity (0.3 nautical mile). After 5 minutes the system will flag and no longer provide course guidance with approach sensitivity. Missed approach course guidance may still be available with 1 nautical mile CDI sensitivity by executing the missed approach.
- E. In an in-flight emergency, depressing and holding the Comm transfer button for 2 seconds will select the emergency frequency of 121.500 Mhz into the "Active" frequency window.

SECTION 4 - NORMAL PROCEDURES

WARNING

Familiarity with the enroute operation of the GNS 430 does not constitute proficiency in approach operations. Do not attempt approach operations in IMC prior to attaining proficiency in the use of the GNS 430 approach feature.

A. DETAILED OPERATING PROCEDURES

Normal operating procedures are described in the GARMIN GNS 430 Pilot's Guide, p/n 190-00140-00, Rev. A, dated October 1998, or later appropriate revision.

B. PILOT'S DISPLAY

The GNS 430 System data will appear on the Pilot's HSI. The source of data is either GPS or VLOC as annunciated on the display above the CDI key.

C. AUTOPILOT/FLIGHT DIRECTOR OPERATION

Coupling of the GNS 430 System steering information to the autopilot/flight director can be accomplished by engaging the autopilot/flight director in the NAV or APR mode.

When the autopilot/flight director system is using course information supplied by the GNS 430 System and the course pointer is not automatically driven to the desired track, the course pointer on the HSI must be manually set to the desired track (DTK) indicated by the GNS 430. For detailed autopilot/flight director operational instructions, refer to the FAA Approved Flight Manual Supplement for the autopilot/flight director.

SECTION 4 - NORMAL PROCEDURES (continued)

D. AUTOMATIC LOCALIZER COURSE CAPTURE

By default, the GNS 430 automatic localizer course capture feature is enabled. This feature provides a method for system navigation data present on the external indicators to be switched automatically from GPS guidance to localizer / glide slope guidance at the point of course intercept on a localizer at which GPS derived course deviation equals localizer derived course deviation. If an offset from the final approach course is being flown, it is possible that the automatic switch from GPS course guidance to localizer / glide slope course guidance will not occur. It is the pilot's responsibility to ensure correct system navigation data is present on the external indicator before continuing a localizer based approach beyond the final approach fix.

SECTION 5 - PERFORMANCE

No change.

SECTION 6 - WEIGHT AND BALANCE

Factory installed optional equipment is included in the licensed weight and balance data in Section 6 of the basic Pilot's Operating Handbook.

SECTION 7 - DESCRIPTION AND OPERATION

See GNS 430 Pilot's Guide for a complete description of the GNS 430 system.

THIS PAGE INTENTIONALLY LEFT BLANK

**PILOT'S OPERATING HANDBOOK
AND
FAA APPROVED AIRPLANE FLIGHT MANUAL**

**SUPPLEMENT NO. 8
FOR
S-TEC SYSTEM 55 TWO AXIS
AUTOMATIC FLIGHT GUIDANCE SYSTEM
WITH TRIM MONITOR**

This supplement must be attached to the Pilot's Operating Handbook and FAA Approved Airplane Flight Manual when the S-TEC System 55 Autopilot is installed per STC SA8402SW-D. The information contained herein supplements or supersedes the basic Pilot's Operating Handbook and FAA Approved Airplane Flight Manual only in those areas listed herein. For limitations, procedures and performance information not contained in the supplement, consult the basic Pilot's Operating Handbook and FAA Approved Airplane Flight Manual.

FAA APPROVED: 

PETER E. PECK
D.O.A. NO. SO-1
THE NEW PIPER AIRCRAFT, INC.
VERO BEACH, FLORIDA

DATE OF APPROVAL: DECEMBER 18, 1998

THIS PAGE INTENTIONALLY LEFT BLANK

**PILOT'S OPERATING HANDBOOK
AND
FAA APPROVED AIRPLANE FLIGHT MANUAL**

**SUPPLEMENT NO. 9
FOR
S-TEC MANUAL ELECTRIC TRIM SYSTEM
WITH TRIM MONITOR
(Serial numbers 2843058 and up)**

The FAA approved operational supplement for the S-TEC Manual Electric Trim System, installed in accordance with STC SA8388SW-D, is required for operation of this system. S-TEC will be responsible to supply and revise the operational supplement. It is permitted to include the S-TEC supplement in this location of the Pilot's Operating Handbook unless otherwise stated by S-TEC. The information contained in the S-TEC supplement may supersede or supplement the information in the basic Pilot's Operating Handbook and FAA Approved Airplane Flight Manual with respect to the operation of the S-TEC Manual Electric Trim System. For limitations, procedures and performance information not contained in the S-TEC supplement, consult the basic Pilot's Operating Handbook and FAA Approved Airplane Flight Manual.

THIS PAGE INTENTIONALLY LEFT BLANK

**PILOT'S OPERATING HANDBOOK
AND
FAA APPROVED AIRPLANE FLIGHT MANUAL**

**SUPPLEMENT NO. 10
FOR
B.F. GOODRICH
SKYWATCH TRAFFIC ADVISORY SYSTEM
MODEL SKY497**

This supplement must be attached to the Pilot's Operating Handbook and FAA Approved Airplane Flight Manual when the optional BF Goodrich Skywatch Traffic Advisory System, Model SKY497 is installed per the Equipment List. The information contained herein supplements or supersedes the Pilot's Operating Handbook and FAA Approved Airplane Flight Manual only in those areas listed herein. For limitations, procedures and performance information not contained in this supplement, consult the Pilot's Operating Handbook and FAA Approved Airplane Flight Manual.

FAA APPROVED: *Christina L. Marsh*
CHRISTINA L. MARSH
D.O.A. NO. SO- I
THE NEW PIPER AIRCRAFT, INC.
VERO BEACH, FLORIDA

DATE OF APPROVAL: July 14, 2000

SECTION 1 - GENERAL

The SKYWATCH system is an on-board traffic advisory system which monitors a radius of 10 nautical miles, of which a maximum of 6 nautical miles are displayed, about the aircraft by interrogating any "intruding" aircraft transponder, and determines if a potential conflict exists with other aircraft. This is done by computing the range, altitude, bearing, and closure rate of other transponder equipped aircraft, with respect to the SKYWATCH equipped aircraft.

SKYWATCH requires the following other equipment to be functional and operating:

No. 1 GNS 430
Encoding Altimeter or Blind Encoder

The SKYWATCH system provides a single level of threat advisory known as a Traffic Advisory (TA). The TA display indicates the relative position of an intruder when it is approximately 30 seconds from Closest Point of Approach (CPA). In addition, all aircraft detected less than 0.55 nm and +/- 800 feet from own aircraft will cause a TA to be generated.

The TA calls attention to a possible collision threat using the GNS 430 display and the voice message "TRAFFIC, TRAFFIC". The TA is intended to assist the pilot in achieving visual acquisition of the threat aircraft.

SKYWATCH is considered a backup system to the "SEE AND AVOID" concept and the ATC radar environment.

SKYWATCH data is presented on the Garmin No. 1 GNS 430 and/or No. 2 GNS 430 nav display. See the POH supplements for operating instructions for these items of equipment. The Standby/Operate feature is controlled by the No. 1 GNS 430.

SECTION 2 - LIMITATIONS

Information shown on the display is provided to the pilot as an aid to visually acquiring traffic. Pilot's should maneuver their aircraft based only on ATC guidance or positive visual acquisition of the conflicting traffic. Maneuver should be consistent with ATC instructions. No maneuvers should be made based only on a Traffic Advisory. ATC should be contacted for resolution of the Traffic conflict.

If the pilot is advised by ATC to disable transponder altitude reporting, SKYWATCH must be turned OFF.

Operation of the SKYWATCH system requires that the SKYWATCH Pilot's Guide, p/n 009-10801-001, Rev. A, or latest revision, and the Garmin 400 Series Pilot's Guide Addendum, p/n 190-00140-10, Rev. A, or latest revision, be kept on the aircraft and available to the pilot at all times.

SKYWATCH can only detect aircraft which are transponder equipped.

SECTION 3 - EMERGENCY PROCEDURES

No change.

SECTION 4 - NORMAL PROCEDURES

SELF TEST

The SKYWATCH operator initiated self test should be run prior to the first flight of the day.

After completion of self test, the "TRAFFIC ADVISORY SYSTEM TEST PASSED" audio annunciation will be heard and the display will revert to the standby screen.

SECTION 4 - NORMAL PROCEDURES (continued)

SELF TEST (continued)

If "TRAFFIC ADVISORY SYSTEM TEST FAILED" is heard or the SKY497 FAILED screen appears, the SKYWATCH system should be turned OFF.

NOTE

The operator initiated Self-Test can only be performed when in standby or failed mode.

STANDBY CHARACTERISTICS

The SKYWATCH system will display STANDBY when in the standby mode. Selecting OPR activates the system and changes the display from the Standby screen to the Above (ABV) mode and 6 nm range. The ranges available are 6 nm, 5 nm, and 2 nm, and are selected by pressing the Display Range Button.

To go back into Standby, select STBY mode. The system will go to the STANDBY screen and will not track targets again until the system is manually switched out of Standby.

The Self Test works while in the Standby screen by pressing the Menu Button and selecting Self Test.

The SKYWATCH system, while in flight or operating on the ground, will display 4 altitude display modes. These are: Above (ABV), Normal (NRM), Below (BLW), and Unrestricted (UNR). These modes are accessed through the GNS selector knobs. Refer to the SKYWATCH Traffic Advisory System Model SKY497 pilot's guide, p/n 009-10801-001, Rev. A, or latest revision and the Garmin 400 Series Pilot's Guide Addendum, p/n 190-00140-10, Rev A, or latest revision.

SECTION 4 - NORMAL PROCEDURES (continued)

ABNORMAL PROCEDURES

If "TRAFFIC ADVISORY SYSTEM TEST FAILED" is heard or the SKY497 FAILED screen appears, the SKYWATCH system should be turned OFF.

If the barometric altimeter fails in flight and is the altitude source for the transponder, turn SKYWATCH OFF.

RESPOND TO TRAFFIC ADVISORIES

When the SKY497 issues a TA, scan outside for the intruder aircraft. Call ATC for guidance and if you visually acquire the traffic, use normal right of way procedures to maintain separation.

Do not attempt maneuvers based solely on traffic information shown on the SKY497 display. Information on the display is provided to the flight crew as an aid in visually acquiring traffic; it is not a replacement for ATC and SEE and AVOID techniques.

SECTION 5 - PERFORMANCE

No change.

SECTION 6 - WEIGHT AND BALANCE

Factory installed optional equipment is included in the licensed weight and balance data in the Equipment List attached to the Pilot's Operating Handbook.

THIS PAGE INTENTIONALLY LEFT BLANK

**PILOT'S OPERATING HANDBOOK
AND
FAA APPROVED AIRPLANE FLIGHT MANUAL**

**SUPPLEMENT NO. 11
FOR
BF GOODRICH AEROSPACE
WX-500 STORMSCOPE - SERIES II WEATHER MAPPING SENSOR**

This supplement must be attached to the Pilot's Operating Handbook and FAA Approved Airplane Flight Manual when the BF Goodrich Aerospace WX-500 Stormscope is installed per the equipment list. The information contained herein supplements or supersedes the Pilot's Operating Handbook and FAA Approved Airplane Flight Manual only in those areas listed herein. For limitations, procedures and performance information not contained in this supplement, consult the Pilot's Operating Handbook and FAA Approved Airplane Flight Manual.

FAA APPROVED:



CHRISTINA L. MARSH

D.O.A. NO. SO- I

THE NEW PIPER AIRCRAFT, INC.
VERO BEACH, FLORIDA

DATE OF APPROVAL: July 14, 2000

SECTION 1 - GENERAL

This supplement provides information necessary for the operation of the aircraft with the BF Goodrich WX-500 Stormscope.

WARNING

Never use your Stormscope system to attempt a thunderstorm. The FAA Advisory Circular, Subject: Thunderstorms, and the Airman's Information Manual (AIM) recommend that a pilot "avoid by at least 20 miles any thunderstorm identified as severe or giving an intense radar echo."

CAUTION

There are several atmospheric phenomena other than nearby thunderstorms that can cause isolated discharge points in the strike display mode. Clusters of two or more discharge points in the strike display mode, however, do indicate thunderstorm activity when they reappear after clearing the screen. Avoid the clusters and you'll avoid the thunderstorms. In the cell display mode, even a single discharge point may represent thunderstorm activity and should be avoided.

SECTION 2 - LIMITATIONS

The BF Goodrich Aerospace WX-500 Stormscope Users Guide, p/n 009-11501-001, Rev. A, dated September 10, 1997, or later appropriate revision, must be immediately available to the flight crew whenever weather avoidance is predicated on the use of this system.

SECTION 3 - EMERGENCY PROCEDURES

No change.

SECTION 4 - NORMAL PROCEDURES

Normal operating procedures are described in the BF Goodrich Aerospace WX-500 Stormscope Users Guide, p/n 009-11501-001, Rev. A, dated September 10, 1997, or later appropriate revision.

SECTION 5 - PERFORMANCE

No change.

SECTION 6 - WEIGHT AND BALANCE

Factory installed optional equipment is included in the licensed empty weight and balance data in Section 6 of the Pilot's Operating Handbook.

SECTION 7 - DESCRIPTION AND OPERATION

A. OPERATING PROCEDURES

See the BF Goodrich Aerospace WX-500 Stormscope Users Guide for a complete description of the WX-500 system.

B. PILOT'S DISPLAY (Airplane Dependent)

The BF Goodrich Aerospace WX-500 Stormscope's data will appear on either of the Garmin GNS 430's.

THIS PAGE INTENTIONALLY LEFT BLANK

**PILOT'S OPERATING HANDBOOK
AND
FAA APPROVED AIRPLANE FLIGHT MANUAL**

**SUPPLEMENT NO. 12
FOR
GARMIN GNS 430 VHF COMMUNICATION
TRANSCEIVER/VOR/ILS RECEIVER/GPS RECEIVER
WITH
TRAFFIC ADVISORY & LIGHTNING STRIKE
ADVISORY DATA**

This supplement must be attached to the Pilot's Operating Handbook and FAA Approved Airplane Flight Manual when the Garmin GNS 430 VHF Communication Transceiver/VOR/ILS Receiver/GPS Receiver with Traffic Advisory & Lightning Strike Advisory Data is installed per the Equipment List. The information contained herein supplements or supersedes the Pilot's Operating Handbook and FAA Approved Airplane Flight Manual only in those areas listed herein. For limitations, procedures and performance information not contained in this supplement, consult the Pilot's Operating Handbook and FAA Approved Airplane Flight Manual.

FAA APPROVED:

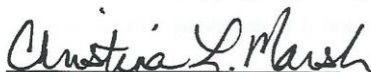

CHRISTINA L. MARSH

D.O.A. NO. SO-1

THE NEW PIPER AIRCRAFT, INC.

VERO BEACH, FLORIDA

DATE OF APPROVAL: July 14, 2000ISSUED: JULY 12, 1995
REVISED: JULY 14, 2000REPORT: VB-1611 |
1 of 8, 9-63 |

SECTION 1 - GENERAL

The GNS 430 System is a fully integrated, panel mounted instrument, which contains a VHF Communications Transceiver, a VOR/ILS Receiver, and a Global Positioning System (GPS) Navigation computer. The system consists of a GPS Antenna, GPS Receiver, VHF VOR/LOC/GS Antenna, VOR/ILS Receiver, VHF COMM Antenna and a VHF Communications Transceiver. The primary function of the VHF Communication portion of the equipment is to facilitate communication with Air Traffic Control. The primary function of the VOR/ILS Receiver portion of the equipment is to receive and demodulate VOR, Localizer, and Glide Slope signals. The primary function of the GPS portion of the system is to acquire signals from the GPS system satellites, recover orbital data, make range and Doppler measurements, and process this information in real-time to obtain the user's position, velocity, and time.

Provided the GARMIN GNS 430's GPS receiver is receiving adequate usable signals, it has been demonstrated capable of and has been shown to meet the accuracy specifications for:

- VFR/IFR enroute, terminal, and non-precision instrument approach (GPS, Loran-C, VOR, VOR-DME, TACAN, NDB, NDB-DME, RNAV) operation within the U.S. National Airspace System in accordance with AC 20-138.
- One of the approved sensors, for a single or dual GNS 430 installation, for North Atlantic Minimum Navigation Performance Specification (MNPS) Airspace in accordance with AC 91-49 and AC 120-33.
- The system meets RNP5 airspace (BRNAV) requirements of AC 90-96 and in accordance with AC 20-138, and JAA AMJ 20X2 Leaflet 2 Revision 1, provided it is receiving usable navigation information from the GPS receiver.

NOTE

Navigation is accomplished using the WGS-84 (NAD-83) coordinate reference datum. Navigation data is based upon use of only the Global Positioning System (GPS) operated by the United States of America.

SECTION 2 - LIMITATIONS

- A. The GARMIN GNS 430 Pilot's Guide, p/n 190-00140-00, Rev. A, dated October 1998, or later appropriate revision, must be immediately available to the flight crew whenever navigation is predicated on the use of the system.

The Garmin 400 Series Pilot's Guide Addendum, p/n 190-00140-10, Rev. A, dated October 1999, Display Interface for Traffic and Weather Data, must be immediately available to the flight crew if the BF Goodrich WX-500 Stormscope or the BF Goodrich SKYWATCH Traffic Advisory System (TAS) is installed.

- B. The GNS 430 must utilize the following or later FAA approved software versions:

Sub-System	Software Version
Main	2.00
GPS	2.00
Comm	1.22
VOR/LOC	1.25
G/S	2.00

The main software version is displayed on the GNS 430 self test page immediately after turn-on for 5 seconds. The remaining system software versions can be verified on the AUX group sub-page 2, "SOFTWARE/DATABASE VER".

SECTION 2 - LIMITATIONS (continued)

- C. IFR enroute and terminal navigation predicated upon the GNS 430's GPS Receiver is prohibited unless the pilot verifies the currency of the data base or verifies each selected waypoint for accuracy by reference to current approved data.
- D. Instrument approach navigation predicated upon the GNS 430's GPS Receiver must be accomplished in accordance with approved instrument approach procedures that are retrieved from the GPS equipment data base. The GPS equipment data base must incorporate the current update cycle.
- E. Instrument approaches utilizing the GPS receiver must be conducted in the approach mode and Receiver Autonomous Integrity Monitoring (RAIM) must be available at the Final Approach Fix.
- F. Accomplishment of ILS, LOC, LOC-BC, LDA, SDF, MLS or any other type of approach not approved for GPS overlay with the GNS 430's GPS receiver is not authorized.
- G. Use of the GNS 430 VOR/ILS receiver to fly approaches not approved for GPS require VOR/ILS navigation data to be present on the external indicator.
- H. When an alternate airport is required by the applicable operating rules, it must be served by an approach based on other than GPS or Loran-C navigation, the aircraft must have the operational equipment capable of using that navigation aid, and the required navigation aid must be operational.
- I. VNAV information may be utilized for advisory information only. Use of VNAV information for Instrument Approach Procedures does not guarantee Step-Down Fix altitude protection, or arrival at approach minimums in normal position to land.

SECTION 2 - LIMITATIONS (continued)

- J. If not previously defined, the following default settings must be made in the "SETUP 1" menu of the GNS 430 prior to operation (refer to Pilot's Guide for procedure if necessary):

1. dis, spd.....ⁿ_m ^k_t (sets navigation units to "nautical miles" and "knots")
2. alt, vs.....ft fpm (sets altitude units to "feet" and "feet per minute")
3. map datum...WGS 84 (sets map datum to WGS-84, see not below)
4. posn.....deg-min (sets navigation grid units to decimal minutes)

NOTE

In some areas outside the United States, datums other than WGS-84 or NAD-83 may be used. If the GNS 430 is authorized for use by the appropriate Airworthiness authority, the required geodetic datum must be set in the GNS 430 prior to its use for navigation.

SECTION 3 - EMERGENCY PROCEDURES

ABNORMAL PROCEDURES

- A. If GARMIN GNS 430 navigation information is not available or invalid, utilize remaining operational navigation equipment as required.
- B. If "RAIM POSITION WARNING" message is displayed the system will flag and no longer provide GPS based navigational guidance. The crew should revert to the GNS 430 VOR/ILS receiver or an alternate means of navigation other than the GNS 430's GPS receiver.
- C. If "RAIM IS NOT AVAILABLE" message is displayed in the enroute, terminal, or initial approach phase of flight, continue to navigate using the GPS equipment or revert to an alternate means of navigation other than the GNS 430's GPS receiver appropriate to the route and phase of flight. When continuing to use GPS navigation, position must be verified every 15 minutes using the GNS 430's VOR/ILS receiver or another IFR-approved navigation system.
- D. If "RAIM IS NOT AVAILABLE" message is displayed while on the final approach segment, GPS based navigation will continue for up to 5 minutes with approach CDI sensitivity (0.3 nautical mile). After 5 minutes the system will flag and no longer provide course guidance with approach sensitivity. Missed approach course guidance may still be available with 1 nautical mile CDI sensitivity by executing the missed approach.
- E. In an in-flight emergency, depressing and holding the Comm transfer button for 2 seconds will select the emergency frequency of 121.500 Mhz into the "Active" frequency window.

SECTION 4 - NORMAL PROCEDURES (continued)

E. DISPLAY OF LIGHTNING STRIKE DATA

Lightning strike data detected by the BF Goodrich WX-500 Stormscope will appear on the moving map and weather pages of the GNS 430. For detailed operating instructions regarding the interface of the GNS 430 with the WX-500, refer to the WX-500 Pilot's Guide and the GNS 430 Pilot's Guide Addendum for the WX-500 Stormscope interface.

F. DISPLAY OF TRAFFIC ADVISORY DATA

Traffic data detected by the BF Goodrich SKYWATCH™ Traffic Advisory System (TAS) will appear on the moving map and traffic display pages of the GNS 430. For detailed operating instructions regarding the interface of the GNS 430 with the SKYWATCH, refer to the FAA approved Flight Manual Supplement for the SKYWATCH, the Pilot's Guide for the SKYWATCH and the GNS 430 Pilot's Guide Addendum for the SKYWATCH Traffic Advisory System interface.

SECTION 5 - PERFORMANCE

No Change.

SECTION 6 - WEIGHT AND BALANCE

Factory installed optional equipment is included in the licensed weight and balance data in the Equipment List attached to the Pilot's Operating Handbook.

SECTION 7 - DESCRIPTION AND OPERATION

See the GNS 430 Pilot's Guide for a complete description of the GNS 430 system.

**PILOT'S OPERATING HANDBOOK
AND
FAA APPROVED AIRPLANE FLIGHT MANUAL**

**SUPPLEMENT NO. 13
FOR
GARMIN GTX 327 TRANSPONDER**

This supplement must be attached to the Pilot's Operating Handbook and FAA Approved Airplane Flight Manual when the Garmin GTX 327 Transponder is installed per the Equipment List. The information contained herein supplements or supersedes the Pilot's Operating Handbook and FAA Approved Airplane Flight Manual only in those areas listed herein. For limitations, procedures and performance information not contained in this supplement, consult the Pilot's Operating Handbook and FAA Approved Airplane Flight Manual.

FAA APPROVED: Christina L. Marsh
CHRISTINA L. MARSH
D.O.A. NO. SO-1
THE NEW PIPER AIRCRAFT, INC.
VERO BEACH, FLORIDA

DATE OF APPROVAL: January 2, 2001

SECTION 1 - GENERAL

This supplement supplies information necessary for the operation of the airplane when the Garmin GTX 327 Transponder is installed in accordance with FAA approved Piper data.

SECTION 2 - LIMITATIONS

No change.

SECTION 3 - EMERGENCY PROCEDURES

To transmit an emergency signal:

- Mode Selection Key - ALT
- Code Selection - SELECT 7700

To transmit a signal representing loss of all communications:

- Mode Selection Key - ALT
- Code Selection - SELECT 7600

SECTION 4 - NORMAL PROCEDURES

BEFORE TAKEOFF:

- To transmit Mode C (Altitude Reporting) code in flight:
- Mode Selection Key - ALT
- Code Selector Keys - SELECT assigned code.

To transmit Mode A (Aircraft Identification) code in flight:

- Mode Selector Key - ON
- Code Selector Keys - SELECT assigned code.

NOTE

During normal operation with the ON mode selected, the reply indicator "R" flashes, indicating transponder replies to interrogations.

NOTE

Mode A reply codes are transmitted in ALT also; however, Mode C codes only are suppressed when the Function Selector ON key is selected.

SECTION 5 - PERFORMANCE

No change.

SECTION 6 - WEIGHT AND BALANCE

Factory installed optional equipment is included in the licensed weight and balance data in section 6 of the Airplane Flight Manual.

SECTION 7 - DESCRIPTION AND OPERATION



The GTX 327 transponder is powered on by pressing the **STBY**, **ALT** or **ON** keys, or by a remote avionics master switch (if applicable). After power on, a start-up page will be displayed while the unit performs a self test.

Mode Selection Keys

OFF - Powers off the GTX 327.

STBY - Powers on the transponder in standby mode.

At power on the last active identification code will be selected. When in standby mode, the transponder will not reply to any interrogations.

ON - Powers on the transponder in Mode A. At power on the last active identification code will be selected. In this mode, the transponder replies to interrogations, as indicated by the Reply Symbol . Replies do not include altitude information.

ALT - Powers on the transponder in Mode A and Mode C. At power on the last active identification code will be selected. In ALT mode, the transponder replies to identification and altitude interrogations, as indicated by the Reply Symbol . Replies to altitude interrogations include the standard pressure altitude received from an external altitude source, which is not adjusted for barometric pressure. The ALT mode may be used in aircraft not equipped with the optional altitude encoder; however, the reply signal will not include altitude information.



GTX 327 Configuration Mode

The GTX 327's configuration, which is normally done at time of installation, influences many of the unit's functions described in this manual. If you wish to view or change any of the GTX 327 configuration parameters, you may access the GTX 327 Configuration Mode. Use caution when changing configuration. When in doubt, contact your authorized GARMIN Aviation Service Center. The Configuration Mode should not be used while the aircraft is airborne.

SECTION 7 - DESCRIPTION AND OPERATION (continued)

GTX 327 Configuration Mode (continued)

To use the GTX 327 Configuration Mode:

1. Press and hold the FUNC key while powering on the unit using the STBY, ON, or ALT key (or using an avionics master switch).
2. Press the FUNC key to sequence through the configuration pages.
3. Use the CRSR key to highlight selectable fields on each page.
4. When a field is highlighted, enter numeric data using the 0 - 9 keys, and select items from a list using the 8 or 9 keys.
5. Press the CRSR key to confirm list selections.

Code Selection



Code selection is done with eight keys (0 - 7) that provide 4,096 active identification codes. Pushing one of these keys begins the code selection sequence. The new code will not be activated until the fourth digit is entered. Pressing the CLR key will move the cursor back to the previous digit. Pressing the CLR key when the cursor is on the first digit of the code, or pressing the CRSR key during code entry, will remove the cursor and cancel data entry, restoring the previous code. The numbers 8 and 9 are not used for code entry, only for entering a Count Down time, and in the Configuration Mode.



SECTION 7 - DESCRIPTION AND OPERATION (continued)

Code Selection (continued)

Important Codes:

- 1200** - The VFR code for any altitude in the US (Refer to ICAO standards elsewhere)
- 7000** - The VFR code commonly used in Europe (Refer to ICAO standards)
- 7500** - Hijack code (Aircraft is subject to unlawful interference)
- 7600** - Loss of communications
- 7700** - Emergency
- 7777** - Military interceptor operations (Never squawk this code)
- 0000** - Military use (Not enterable)

Care should be taken not to select the code 7500 and all codes in the 7600 - 7777 range, which trigger special indicators in automated facilities. Only the code 7500 will be decoded as the hijack code. An aircraft's transponder code (when available) is utilized to enhance the tracking capabilities of the ATC facility, therefore care should be taken when making routine code changes.

Keys for Other GTX 327 Functions



IDENT - Pressing the IDENT key activates the Special Position Identification (SPI) Pulse for 18 seconds, identifying your transponder return from others on the air traffic controller's screen. The word "IDENT" will appear in the upper left corner of the display while the IDENT mode is active.





VFR - Sets the transponder code to the pre-programmed VFR code selected in Configuration Mode (this is set to 1200 at the factory). Pressing the VFR key again will restore the previous identification code.





FUNC - Changes the page shown on the right side of the display. Displayed data includes Pressure Altitude, Flight Time, Count Up timer, Count Down timer, and may include Contrast and Display Brightness, depending on configuration (as shown in the screens below):

SECTION 7 - DESCRIPTION AND OPERATION (continued)**Keys for Other GTX 327 Functions (continued)**

PRESSURE ALT **PRESSURE ALT:** Displays the altitude data supplied to the
 GTX 327 in feet, hundreds of feet (i.e., flight level), or meters, depending on configuration.

FLIGHT TIME **FLIGHT TIME:** Displays the Flight Time, which is controlled
 by the **START/STOP** key or by a squat switch as configured during installation. With squat switch control, the timer begins when lift off is sensed and pauses when landing is sensed.

COUNT UP **COUNT UP TIMER:** Controlled by **START/STOP** and **CLR**
 keys.

COUNT DOWN **COUNT DOWN TIMER:** Controlled by **START/STOP**, **CLR**,
 and **CRSR** keys. The initial Count Down time is entered with the **0 - 9** keys.

CONTRAST **CONTRAST:** This page is only displayed if manual contrast
 mode is selected in Configuration Mode. Contrast is controlled by the **8** and **9** keys.

DISPLAY **DISPLAY:** This page is only displayed if manual backlighting
 mode is selected in Configuration Mode. Backlighting is controlled by the **8** and **9** keys.



START/STOP - Starts and stops the Count Up and Count Down timers.



CRSR - Initiates entry of the starting time for the Count Down timer and cancels transponder code entry.



CLR - Resets the Count Up and Count Down timers and cancels the previous keypress during code selection.



8 - Reduces Contrast and Display Brightness when the respective pages are displayed. Also enters the number 8 into the Count Down timer.



9 - Increases Contrast and Display Brightness when the respective pages are displayed. Also enters the number 9 into the Count Down timer.

SECTION 7 - DESCRIPTION AND OPERATION (continued)

Altitude Trend Indicator

When the "PRESSURE ALT" page is displayed, an arrow may be displayed to the right of the altitude, indicating that the altitude is increasing or decreasing. One of two sizes of arrows may be displayed depending on the rate of climb/descent. The sensitivity of these arrows is set using the GTX Configuration Mode.

Timer Operation

To operate the Flight Timer:

1. Press the FUNC key until "FLIGHT TIME" is displayed.
2. If the GTX 327 is configured as having a squat switch installed, the timer will begin counting automatically when the squat switch senses that the aircraft has become airborne.
3. If desired, you may press **START/STOP** to pause or restart the timer.
4. Press **CLR** to reset the timer to zero.
5. If the GTX 327 is configured as having a squat switch installed, the timer will pause automatically when the squat switch senses that the aircraft has touched down.

To operate the Count Up timer:

1. Press the FUNC key until "COUNT UP" is displayed.
2. If necessary, press **CLR** to reset the Count Up timer to zero.
3. Press **START/STOP** to count up.
4. Press **START/STOP** again to pause the timer.
5. Press **CLR** to reset the timer to zero.

To operate the Count Down timer:

1. Press the FUNC key until "COUNT DOWN" is displayed.
2. Press **CRSR** and use the **0 - 9** keys to set the initial time. All digits must be entered (use the 0 key to enter leading zeros).
3. Press **START/STOP** to count down.
4. Press **START/STOP** again to pause the timer.
5. When the Count Down timer expires, the words "COUNT DOWN" are replaced with "EXPIRED", and the time begins counting up and flashing.
6. Press **CLR** to reset the timer to the initial time value.

THIS PAGE INTENTIONALLY LEFT BLANK

**PILOT'S OPERATING HANDBOOK
AND
FAA APPROVED AIRPLANE FLIGHT MANUAL**

**SUPPLEMENT NO. 14
FOR
S-TEC SYSTEM 55X TWO AXIS
AUTOMATIC FLIGHT GUIDANCE SYSTEM**

The FAA approved operational supplement for the S-TEC System 55X Autopilot, installed in accordance with STC SA8402-SW-D, is required for operation of this system. S-TEC will be responsible to supply and revise the operational supplement. It is permitted to include the S-TEC supplement in this location of the Pilot's Operating Handbook unless otherwise stated by S-TEC. The information contained in the S-TEC supplement may supersede or supplement the information in the basic Pilot's Operating Handbook and FAA Approved Airplane Flight Manual with respect to the operation of the S-TEC System 55X Autopilot. For limitations, procedures and performance information not contained in the S-TEC supplement, consult the basic Pilot's Operating Handbook and FAA Approved Airplane Flight Manual.

THIS PAGE INTENTIONALLY LEFT BLANK

S-TEC CORPORATION
MINERAL WELLS, TEXAS 76067

FAA/DAS APPROVED
PILOT'S OPERATING HANDBOOK AND/OR
AIRPLANE FLIGHT MANUAL SUPPLEMENT
FOR
PIPER MODEL PA-28-181
WITH
S-TEC SYSTEM 55/55X TWO AXIS
AUTOMATIC FLIGHT GUIDANCE SYSTEM
WITH TRIM MONITOR
(28 VOLT SYSTEM)

REG. NO. SE-ILV

SER. NO. 2843426

This Supplement must be attached to the applicable FAA Approved Airplane Flight Manual, Pilot's Operating Handbook, or Pilot's Operating Handbook and FAA Approved Airplane Flight Manual for aircraft modified by the installation of S-TEC System 55/55X Autopilot Model ST-548 installed in accordance with STC SA8402SW-D. The information contained herein supplements or supersedes the basic manual. For limitations, procedures and performance information not contained in this supplement, consult the basic Pilot's Operating Handbook and/or Airplane Flight Manual.

SECTION I

GENERAL

This manual is to acquaint the pilot with the features and functions of the System 55/55X Two Axis Autopilot and to provide operating instructions for the system when installed in the listed aircraft model(s). The aircraft must be operated within the limitations herein provided when the autopilot is in use.

FAA/DAS APPROVED



Walter F. Davis

S-TEC CORPORATION
DAS 5 SW
P/N: 891752
DATE: 6-18-98

S-TEC CORPORATION
MINERAL WELLS, TEXAS 76067

FAA/DAS APPROVED
PILOT'S OPERATING HANDBOOK AND/OR
AIRPLANE FLIGHT MANUAL SUPPLEMENT
FOR
PIPER MODEL PA-28-181

LOG OF REVISIONS				
REV. NO.	PAGES AFFECTED	DESCRIPTION	APPROVED	DATE
1	Page 4	Added a Note to Normal Operating Procedures regarding altitude hold capture.	W.F.D	10-05-98
2	Pages 1, 3, 4, 6, 7, 8	Added System 55X information. Removed Optional Equipment section. Renumbered pages.	WFD	11-20-00

FAA/DAS APPROVED
P/N: 891752
DATE: 6-18-98

FAA/DAS APPROVED
PILOT'S OPERATING HANDBOOK AND/OR
AIRPLANE FLIGHT MANUAL SUPPLEMENT
FOR
PIPER MODEL PA-28-181

.....

SECTION II

OPERATING LIMITATIONS

1. Autopilot operation prohibited above 140 KIAS.
2. Autopilot coupled missed approach or go-around maneuver not authorized.
3. Autopilot must be "OFF" during take off and landing.
4. Flap limitations: Maximum flap deflection is limited to 10° (one notch) with autopilot engaged.
5. Category I operations only.
6. Autopilot use prohibited below 200' AGL during coupled approach operations.
7. S-TEC System 55 Pilot's Operating Handbook, P/N 8747, dated 10-16-00 or later revision, or S-TEC System 55X Pilot's Operating Handbook, P/N 87109, dated 11-08-00 or later revision, must be carried in the aircraft and be available to the pilot while in flight.

SECTION III

EMERGENCY OPERATING PROCEDURES

In the event of an autopilot malfunction, or anytime the autopilot is not performing as expected or commanded, do not attempt to identify the system problem. Immediately regain control of the aircraft by overpowering the autopilot as necessary and then immediately disconnect the autopilot. Do not re-engage the autopilot until the problem has been identified and corrected.

1. The autopilot may be disconnected by:
 - a. Depressing the "AP Disconnect" Switch on the left horn of the pilot's control wheel.
 - b. Placing the "AP Master Switch" in the "OFF" position.
 - c. Momentarily interrupting aircraft electrical power at the battery master switch.
 - d. Pulling the autopilot circuit breaker.
2. Trim:
 - a. In the event of a trim failure, manually control aircraft and DEPRESS AND HOLD "Trim Interrupt/AP Disconnect Switch" on control wheel.

FAA/DAS APPROVED
PILOT'S OPERATING HANDBOOK AND/OR
AIRPLANE FLIGHT MANUAL SUPPLEMENT
FOR
PIPER MODEL PA-28-181

-
- b. Place trim master switch in "OFF" position, pull circuit breaker, release interrupt switch.
 - c. Retrim aircraft. Leave trim system OFF until corrected.

3. Altitude loss during a malfunction and recovery:

- a. The following altitude losses and bank angles were recorded after a malfunction with a 3 second recovery delay:

<u>Configuration</u>	<u>Bank Angle/Altitude Loss</u>
Climb	50°/-180'
Cruise	55°/-160'
Descent	55°/-320'

- b. The following altitude losses and bank angles were recorded after a malfunction with a 1 second recovery delay:

<u>Configuration</u>	<u>Bank Angle/Altitude Loss</u>
Maneuvering	18°/-60'
Approach (Coupled or Uncoupled)	20°/-80'

The above values are the worst case for all the models covered by this document.

SECTION IV

NORMAL OPERATING PROCEDURES

For detailed normal operating procedures, including system description, pre-flight and in flight procedures refer to S-TEC System 55 Pilot's Operating Handbook, P/N 8747, dated 10-16-00 or later revision, or S-TEC System 55X Pilot's Operating Handbook, P/N 87109, dated 11-08-00 or later revision.

CAUTION: When S-TEC Flight Director is installed and operating, the Flight Director Autopilot should be disconnected using the control wheel disconnect switch only. Any other means of disconnect (breaker, ON-OFF switch, etc.) may leave steering bars in view, but inoperable.

NOTE: For smoother altitude captures, thus enhancing passenger comfort, engage altitude hold mode at rates of climb of 1,000 FPM or less.

FAA/DAS APPROVED
P/N: 891752
DATE: 6-18-98

FAA/DAS APPROVED
PILOT'S OPERATING HANDBOOK AND/OR
AIRPLANE FLIGHT MANUAL SUPPLEMENT
FOR
PIPER MODEL PA-28-181

CONTROL WHEEL SWITCHES

The left grip of the pilot's control wheel will normally contain the following autopilot switches:

- Manual Electric Trim
- Trim Interrupt/A/P Disconnect Switch
- Control Wheel Steering (CWS)

ELECTRIC TRIM SYSTEM

The S-TEC Electric Trim System is designed to accept any single failure, either mechanical or electrical, without uncontrolled operation resulting during operations in the Manual Electric Trim Mode. During autotrim mode the system is designed to limit the effect of any failure causing trim operation. In order to assure proper operation of these safeguards, it is necessary to conduct a simple pre-flight test of the system. Following is a brief description and a preflight test procedure for the trim system.

TRIM SYSTEM WITH TRIM MONITOR

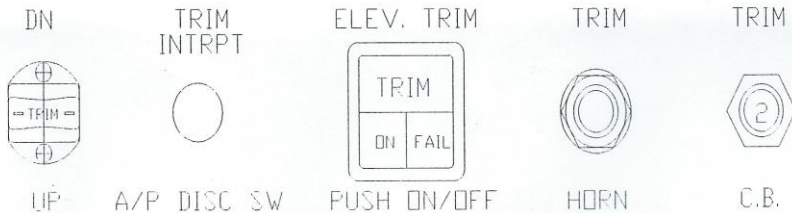

FIGURE 1

SYSTEM DESCRIPTION

The trim monitor system consists of the components pictured in Figure 1 and is designed to alert the pilot of a trim failure or trim in motion.

FAA/DAS APPROVED
PILOT'S OPERATING HANDBOOK AND/OR
AIRPLANE FLIGHT MANUAL SUPPLEMENT
FOR
PIPER MODEL PA-28-181

.....

The system is activated by pushing the trim master switch on. A green On light, a yellow Trim light and a red Fail light will illuminate in the switch and the trim audio horn will activate for one second, as a test. A trim fault will cause the Trim and Fail lights to illuminate along with continuous horn operation. The pilot should press and hold the red Trim Interrupt button and conduct the emergency procedures listed in Section III of this AFMS.

PREFLIGHT TRIM CHECK (With Trim Monitor)

MANUAL ELECTRIC TRIM - Test Prior To Each Flight

1. Check trim circuit breaker - IN
2. Trim master switch - Push ON - confirm green light ON after completion of test cycle.
3. A/P master switch - ON
4. Operate trim switch (both knob sections) - NOSE DN. Check that trim moves nose down and yellow trim light in trim master switch flashes while trim is in motion. The trim "in motion" indicator in the autopilot programmer should flash "TRIM" also. Conduct the same test in the NOSE UP direction.
5. With trim operating up or down depress the red control wheel interrupt switch for three seconds minimum. Confirm that trim action stops while switch is pressed. This action should also trigger the trim monitor horn with "Trim" steady and "Fail" flashing in the trim master switch. Recycle the trim master switch to delete the horn.
6. Overpower check - With trim operating electrically, grasp the manual trim wheel and overpower the electric trim to stop trim motion.
7. Operate each half of the trim switch separately - Trim should not operate unless both switch knob segments are moved together.

AUTOTRIM

1. Position elevator control half way aft from full forward.
2. Engage HDG and ALT modes of autopilot.
3. Grasp control and slowly apply forward pressure (nose down). After approximately 3 seconds automatic trim should run NOSE UP. The yellow trim indicator in trim master switch should flash simultaneously with the trim indicator in the A/P programmer.
4. Conduct the same test by slowly applying aft pressure on the elevator control, confirming that autotrim runs NOSE DOWN and trim indicators flash while trim is in motion.

FAA/DAS APPROVED
P/N: 891752
DATE: 6-18-98

FAA/DAS APPROVED
PILOT'S OPERATING HANDBOOK AND/OR
AIRPLANE FLIGHT MANUAL SUPPLEMENT
FOR
PIPER MODEL PA-28-181

-
5. Move manual trim switch up or down - Autopilot should disconnect and trim should operate in the commanded direction. (Trim switch will disconnect A/P only when a pitch mode is engaged.)
 6. Reengage autopilot HDG and ALT modes - Press trim interrupt/AP disconnect switch - Autopilot should disconnect.
 7. Retrim aircraft for take off - Check all controls for freedom of motion and determine that autopilot and trim have disconnected.

If either the manual electric or autotrim fails any portion of the above check procedure, push the Trim Master Switch "OFF" and do not attempt to use the trim system until the fault is corrected. With the Trim Master Switch "OFF" the autopilot trim indicators will return to operation. If the electric trim system suffers a power failure in flight the system will automatically revert to the trim indicator lights located in the autopilot annunciator panel. If this occurs push the Trim Master Switch "OFF" and trim manually, using the indicators until the fault can be located and corrected.

GLIDE SLOPE FLIGHT PROCEDURE

Approach the GS intercept point (usually the OM) with the flaps set to approach deflection of up to 1 notch, as desired (see Limitations section), and with the aircraft stabilized in altitude hold mode. At the glide slope intercept, adjust power for the desired descent speed. For best tracking results make power adjustments in small, smooth increments to maintain desired airspeed. At the missed approach point or the decision height, disconnect the autopilot for landing or for the go-around maneuver (See Limitations Section). If a missed approach is required, the autopilot may be reengaged after the aircraft has been reconfigured for and established in a stabilized climb.

SECTION V

PERFORMANCE

The text of this Section not affected by installation of this equipment.

SECTION VI

WEIGHT AND BALANCE

The text of this Section not affected by installation of this equipment.

FAA/DAS APPROVED
P/N: 891752
DATE: 6-18-98

FAA/DAS APPROVED
PILOT'S OPERATING HANDBOOK AND/OR
AIRPLANE FLIGHT MANUAL SUPPLEMENT
FOR
PIPER MODEL PA-28-181

.....

SECTION VII

SYSTEMS DESCRIPTION AND OPERATION

The text of this Section not affected by installation of this equipment.

SECTION VIII

HANDLING, SERVICING, AND MAINTENANCE

The text of this Section not affected by installation of this equipment.

SECTION IX

SUPPLEMENTS

See information in this supplement for operation of the S-TEC System |
55/55X Autopilot.

SECTION X

OPERATING TIPS

The text of this Section not affected by installation of this equipment.

**PILOT'S OPERATING HANDBOOK
AND
FAA APPROVED AIRPLANE FLIGHT MANUAL**

**SUPPLEMENT NO. 15
FOR
S-TEC ADF-650A SYSTEM**

This supplement must be attached to the Pilot's Operating Handbook and FAA Approved Airplane Flight Manual when the S-TEC ADF-650A System is installed per the Equipment List. The information contained herein supplements or supersedes the Pilot's Operating Handbook and FAA Approved Airplane Flight Manual only in those areas listed herein. For limitations, procedures and performance information not contained in this supplement, consult the Pilot's Operating Handbook and FAA Approved Airplane Flight Manual.

FAA APPROVED:



CHRISTINA L. MARSH
D.O.A. NO. SO- 1
THE NEW PIPER AIRCRAFT, INC.
VERO BEACH, FLORIDA

DATE OF APPROVAL: January 2, 2001

SECTION 1 - GENERAL

This supplement supplies information necessary for the operation of the airplane when the S-TEC ADF-650A System is installed in accordance with FAA approved Piper data.

SECTION 2 - LIMITATIONS

No change.

SECTION 3 - EMERGENCY PROCEDURES

No change.

SECTION 4 - NORMAL PROCEDURES

To operate as an Automatic Direction Finder:

- OFF/VOL Control - ON
- Frequency Selector Knobs - SELECT desired frequency.
- ADF SPEAKER/PHONE Selector Switch (on audio control panel) - SELECT as desired.
- OFF/VOL Control - SET to desired volume level.
- ADF Mode Control - Select ADF mode and note relative bearing on display.

ADF Test (Pre-flight or In-flight):

- ADF Mode Control - Select ADF mode and note relative bearing on display.
- Press the TEST button and note the pointer moves to 90° from its prior position. Excessive pointer sluggishness, wavering or reversals indicate a signal that is too weak or a system malfunction.

To Operate BFO:

- OFF/VOL Control - ON
- Frequency Selector Knobs - SELECT desired frequency.
- ADF SPEAKER/PHONE Selector Switch (on audio control panel) - SELECT as desired.
- ADF Mode Control - Select BFO mode.
- OFF/VOL Control - Set to desired volume level.

SECTION 5 - PERFORMANCE

No change.

SECTION 6 - WEIGHT AND BALANCE

Factory installed optional equipment is included in the licensed weight and balance data in Section 6 of the Pilot's Operating Handbook and Airplane Flight Manual.

SECTION 7 - DESCRIPTION AND OPERATION

The S-TEC ADF-650A System operates over a frequency range of 200 through 1799 kHz in 1-kHz increments. Three operating modes are included as part of the ADF-650 System.

- BFO
- ANT
- ADF

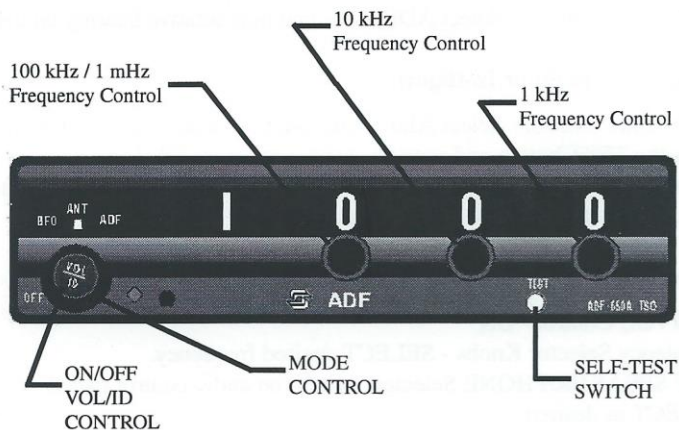

ADF-650A Receiver, Controls, and Indicators

Figure 1

BFO Mode

The BFO (beat frequency oscillator) and ADF (automatic direction finding) modes are navigation modes that result in pointing operation when in-range station is selected. The ADF mode is used with conventional nondirectional beacons and AM broadcast stations. The BFO mode is used to aurally identify stations that employ keyed cw rather than amplitude modulation techniques.

NOTE

CW signals (Morse Code) are unmodulated and no audio will be heard without use of BFO. This type of signal is not used in the United States air navigation. It is used in some foreign countries and marine beacons.

SECTION 7 - DESCRIPTION AND OPERATION (continued)

ANT (Antenna) Mode

The ANT (antenna) mode cannot be used for navigation; this mode enhances audio reception clarity and is normally used for station identification.

ADF Mode

Automatic Direction Finder (ADF) mode is used for navigation. This mode activates the bearing pointer. The bearing pointer will point in the direction of the station relative to the aircraft heading.

Frequency Selector Controls

Three controls are used to select the system operating frequency. The right hand control selects 1 - kHz increments, the center control 10 - kHz increments, and the left hand control 100 - kHz increments.

Self Test Switch

Pressing and holding the spring loaded self test switch while in the ADF mode will cause the bearing pointer to rotate 90 degrees from its prior position if the ADF-650 system is operating properly. When the test switch is released, the bearing pointer should promptly return to its starting point. At this time, normal operation is restored.

ON/OFF/VOL/ID Control

This control performs three independent functions. In full ccw position, no power is applied to the system; rotating the control cw applies power and continued rotation increases volume. Pulling the knob out enhances the Morse code station identifier when background noise is present; push the knob to hear voice transmissions. A good operating practice is to pull the knob out for station identification purposes and then push it back in after positive identification has been made.

THIS PAGE INTENTIONALLY LEFT BLANK

**PILOT'S OPERATING HANDBOOK
AND
FAA APPROVED AIRPLANE FLIGHT MANUAL**

**SUPPLEMENT NO. 16
FOR
GARMIN GMA 340 AUDIO PANEL**

This supplement must be attached to the Pilot's Operating Handbook and FAA Approved Airplane Flight Manual when the Garmin GMA 340 is installed per the Equipment List. The information contained herein supplements or supersedes the information in the basic Pilot's Operating Handbook and FAA Approved Airplane Flight Manual only in those areas listed herein. For limitations, procedures, and performance information not contained in this supplement, consult the basic Pilot's Operating Handbook and FAA Approved Airplane Flight Manual.

FAA APPROVED

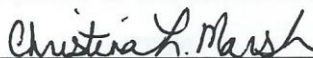

CHRISTINA L. MARSH
D.O.A. NO. SO-1
THE NEW PIPER AIRCRAFT, INC.
VERO BEACH, FLORIDA

DATE OF APPROVAL January 2, 2001

SECTION 1 - GENERAL

This supplement supplies information necessary for the operation of the airplane when the Garmin GMA 340 audio panel is installed in accordance with FAA approved Piper data.

SECTION 2 - LIMITATIONS

No change.

SECTION 3 - EMERGENCY PROCEDURES

No change.

SECTION 4 - NORMAL PROCEDURES

AUDIO CONTROL SYSTEM OPERATION:

- Select the desired transmitter audio selector button (COM1, COM2, OR COM3) and verify that the buttons LED is illuminated.
- INTERCOM VOL Control (ICS) - Adjust to desired listening level.
- INTERCOM VOX (voice) Sensitivity Control - ROTATE CONTROL knob clockwise to the middle range and then adjust as required for desired voice activation or hot mic intercom.
- If desired, select the speaker function button. Selecting this button allows radio transmissions to be received over the cabin speaker.

NOTE

Audio level is controlled by the selected NAV radio volume control.

MARKER BEACON RECEIVER OPERATION:

- TEST Button - PRESS to verify all marker lights are operational.
- SENS Button - SELECT HI for airway flying for LO for ILS/LOC approaches.

SECTION 5 - PERFORMANCE

No change.

SECTION 6 - WEIGHT AND BALANCE

Factory installed optional equipment is included in the licensed weight and balance data in section 6 of the Airplane Flight Manual.

SECTION 7 - DESCRIPTION AND OPERATION

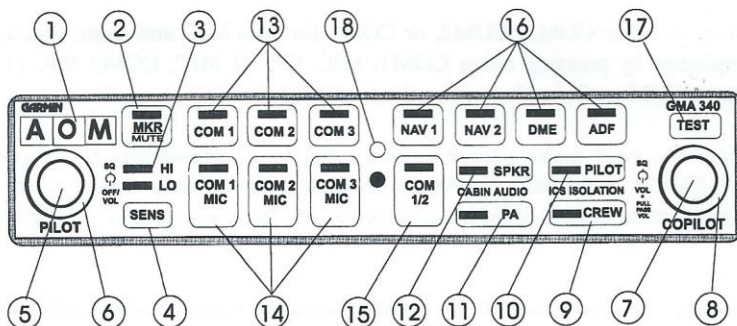

1. Marker Beacon Lamps
2. Marker Beacon Receiver Audio Select/Mute Button
3. Marker Beacon Receiver Sensitivity Selection Indicator LED
4. Marker Beacon Receiver Sensitivity Selection Button
5. Unit On/Off, Pilot Intercom System (ICS) Volume
6. Pilot ICS Voice Activated (VOX) Intercom Squelch Level
7. Copilot and Passenger ICS Volume Control (Pull out for Passenger Volume)
8. Copilot/Passenger VOX Intercom Squelch Level
9. Crew Isolation Intercom Mode Button
10. Pilot Isolation Intercom Mode Button
11. Passenger Address (PA) Function Button
12. Speaker Function Button
13. Transceiver Audio Selector Buttons (COM1, COM2, COM3)
14. Transmitter (Audio/Mic) Selection Buttons
15. Split COM Button
16. Aircraft Radio Audio Selection Buttons (NAV1, NAV2, DME, ADF)
17. Annunciator Test Button
18. Photocell - Automatic Annunciator Dimming

SECTION 7 - DESCRIPTION AND OPERATION (continued)

ON/OFF, Pilot Intercom System (ICS) Volume Control

The GMA 340 is powered OFF when the left small knob (5) is rotated fully CCW into the detent. To turn the unit ON, rotate the knob clockwise past the click. The knob then functions as the pilot ICS volume control. A fail safe circuit connects the pilot's headset and microphone directly to COM1 in case power is interrupted or the unit is turned OFF.

Transceivers

Selection of either COM1, COM2, or COM3 for both MIC and audio source is accomplished by pressing either COM1, MIC, COM2 MIC, COM3 MIC (14). The active COM audio is always heard on the headphones.

Additionally, each audio source can be selected independently by pressing COM1, COM2, or COM3 (13). When selected this way, they remain active as audio sources regardless of which transceiver has been selected for microphone use.

When a microphone is keyed, the active transceiver's MIC button LED blinks approximately one per second to indicate that the radio is transmitting.

NOTE

Audio level is controlled by the selected COM radio volume controls.

Split COM

Pressing the COM 1/2 button (15) activates the split COM function. When this mode is active, COM1 is dedicated solely to the pilot for MIC/Audio while COM2 is dedicated to the copilot for MIC/Audio. The pilot and copilot can simultaneously transmit in this mode over separate radios. Both pilots can still listen to COM3, NAV1, NAV2, DME, ADF, and MRK as selected. The split COM mode is cancelled by pressing the COM 1/2 button a second time.

When in the split COM mode the copilot may make PA announcements while the pilot continues using COM1 independently. When the PA button is pressed after the split com mode is activated the copilot's mic is output over the cabin speaker when keyed. A second press of the PA button returns the copilot to normal split COM operation.

SECTION 7 - DESCRIPTION AND OPERATION (continued)**Aircraft Radios and Navigation**

Pressing NAV1, NAV2, DME, ADF (16) or MRK (2) selects each audio source. A second button press deselects the audio.

Speaker Output

Pressing the SPKR button (12) selects the aircraft radios over the cabin speaker. The speaker output is muted when a COM microphone is keyed.

PA Function

The PA mode is activated by pressing the PA button (11). Then, when either the pilot's or copilot's microphone is keyed, the corresponding mic audio is heard over the cabin speaker. If the SKR button is also active, then any selected speaker audio is muted while the microphone is keyed. The SPKR button does not have to be previously active in order to use the PA function.

Intercom System (ICS)

Intercom volume and squelch (VOX) are adjusted using the following front panel knobs:

- **Left Small Knob** - Unit ON/OFF power control and pilot's ICS volume. Full CCW detent position is OFF.
- **Left Large Knob** - Pilot ICS mic VOX squelch level. CW rotation increases the amount of mic audio (VOX level) required to break squelch. Full CCW is the "HOT MIC" position (no squelch).
- **Right Small Knob** - IN position: Copilot ICS volume. OUT position: Passenger ICS volume.
- **Right Large Knob** - Copilot and passenger mic VOX squelch level. CW rotation increases the amount of mic audio (VOX level) required to break squelch. Full CCW is the "HOT MIC" position.
- **PILOT Mode** - This mode isolates the pilot from everyone else and dedicates the aircraft radios to the pilot exclusively. The copilot and passengers share communications between themselves but cannot communicate with the pilot or hear the aircraft radios.
- **CREW Mode** - This mode places the pilot and copilot on a common ICS communication channel with the aircraft radios. The passengers are on their own intercom channel and can communicate with each other, but cannot communicate with the crew or hear the aircraft radios.

SECTION 7 - DESCRIPTION AND OPERATION (continued)

Marker Beacon Receiver

The GMA 340's marker beacon receiver controls are located on the left side of the front panel (1 - 4). The SENS button selects either high or low sensitivity as indicated by the HI or LO LED being lit. Low sensitivity is used on ILS approaches while high sensitivity allows operation over airway markers or to get an earlier indication of nearing the outer marker during an approach.

The marker audio is initially selected by pressing the MKR/Mute button (2). If no beacon signal is received, then a second button press will deselect the marker audio. This operation is similar to selecting any other audio source on the GMA 340. However, if the second button press occurs while a marker beacon signal is received, then the marker audio is muted but not deselected. The buttons LED will remain lit to indicate that the source is still selected. When the current marker signal is no longer received, the audio is automatically un-muted. While in the muted state, pressing the MKR/Mute button deselects the marker audio. The button's LED will extinguish to indicate that the marker audio is no longer selected.

**PILOT'S OPERATING HANDBOOK
AND
FAA APPROVED AIRPLANE FLIGHT MANUAL**

**SUPPLEMENT NO. 17
FOR
S-TEC DME-450**

This supplement must be attached to the Pilot's Operating Handbook and FAA Approved Airplane Flight Manual when the S-TEC DME-450 is installed per the Equipment List. The information contained herein supplements or supersedes the Pilot's Operating Handbook and FAA Approved Airplane Flight Manual only in those areas listed herein. For limitations, procedures and performance information not contained in this supplement, consult the Pilot's Operating Handbook and FAA Approved Airplane Flight Manual.

FAA APPROVED:



CHRISTINA L. MARSH

D.O.A. NO. SO- 1

THE NEW PIPER AIRCRAFT, INC.

VERO BEACH, FLORIDA

DATE OF APPROVAL: January 2, 2001

SECTION 1 - GENERAL

The S-TEC DME-450 system is a full feature, solid state, remote mounted system with full 200 channel capability. For long distance operation, it provides a full 100 watts maximum pulse power transmitter output.

The IND-450 indicator (see figure 1) provides selectable read-out of distance to/from the station, ground speed, and time to/from the station. Features also include automatic display dimming and waypoint annunciation.

SECTION 2 - LIMITATIONS

No change.

SECTION 3 - EMERGENCY PROCEDURES

No change.

SECTION 4 - NORMAL PROCEDURES

DME OPERATION

- DME Mode Selector Switch - Set to DME 1 or DME 2
- NAV 1 and NAV 2 VHF Navigation Receivers - ON; SET FREQUENCY to VOR/DME station frequencies, as required.

NOTE

When the VOR frequency is selected, the appropriate DME Frequency is automatically channeled.

- DME audio selector button (on audio selector panel) - SET to desired mode.

SECTION 5 - PERFORMANCE

No change.

SECTION 6 - WEIGHT AND BALANCE

Factory installed optional equipment is included in the licensed weight and balance data in Section 6 of the Pilot's Operating Handbook and Airplane Flight Manual.

SECTION 7 - DESCRIPTION AND OPERATION**IND-450**

Figure 1

1. **DISTANCE DISPLAY (NM)** - DME distance to VORTAC/WAYPOINT displayed in .1 nautical mile increments up to 99.9 NM, then in increments of one nautical mile.
2. **GROUND SPEED DISPLAY (KTS)** - Displays ground speed in knots to or from VORTAC/WAYPOINT up to 999 knots (aircraft must be flying directly to or from the VORTAC/WAYPOINT for true ground speed indication).
3. **TIME TO STATION DISPLAY (MIN)** - Displays time to station (VORTAC/WAYPOINT) in minutes up to 99 minutes (aircraft must be flying directly to or from the VORTAC/WAYPOINT for true time to the station indication).

7 - DESCRIPTION AND OPERATION (continued)

4. DME ON/OFF SWITCH - Turns DME power on or off.

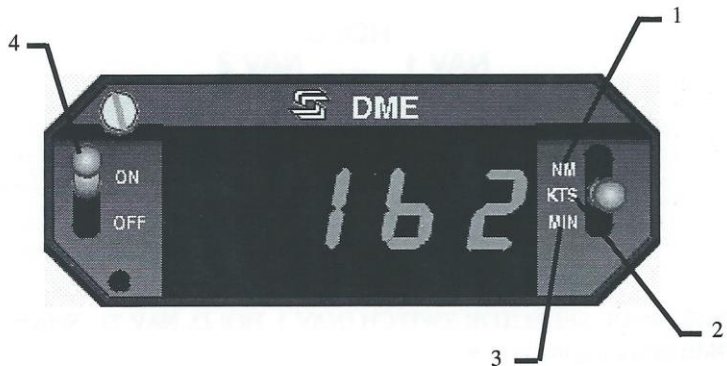
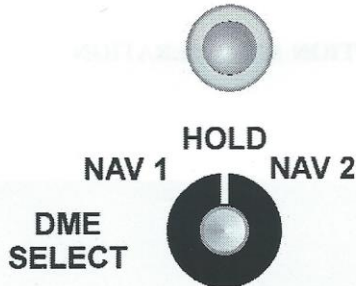

Mode Selector Switch

Figure 2

5. DME MODE SELECTOR SWITCH (NAV 1, HOLD, NAV 2) - Selects DME operating mode as follows:

NAV 1 - Selects DME operation with NO. 1 VHF navigation set; enables channel selection by NAV 1 frequency selector controls.

HOLD - Selects DME memory circuit; DME remains channeled to station to which it was last channeled when HOLD was selected and will continue to display information relative to this channel. Allows both the NAV 1 and NAV 2 navigation receivers to be set to new operational frequencies without affecting the previously selected DME operation.

NOTE

In the HOLD mode there is no annunciation of the VOR/DME station frequency. However, an annunciator light located above the HOLD position of the selector illuminates to inform the pilot that the DME is in the HOLD mode.

NAV 2 - Selects DME operation with NO. 2 VHF navigation set; enables channel selection by NAV 2 frequency selector controls.

PILOT'S OPERATING HANDBOOK
AND
FAA APPROVED AIRPLANE FLIGHT MANUAL

SUPPLEMENT NO. 18
FOR
GARMIN GTX 330 TRANSPONDER

This supplement must be attached to the Pilot's Operating Handbook and FAA Approved Airplane Flight Manual when the Garmin GTX 330 Transponder is installed per the Equipment List. The information contained herein supplements or supersedes the Pilot's Operating Handbook and FAA Approved Airplane Flight Manual only in those areas listed herein. For limitations, procedures and performance information not contained in this supplement, consult the Pilot's Operating Handbook and FAA Approved Airplane Flight Manual.

FAA APPROVED:

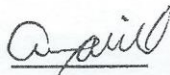

ALBERT J. MILL
D.O.A. NO. SO - 1
THE NEW PIPER AIRCRAFT, INC.
VERO BEACH, FLORIDA

DATE OF APPROVAL: January 5, 2004

ISSUED: JULY 12, 1995
REVISED: JANUARY 5, 2004

REPORT: VB-1611
1 of 4, 9-99

SECTION 1 - GENERAL

This supplement supplies information necessary for the operation of the airplane when the Garmin GTX 330 Transponder is installed in accordance with FAA approved Piper data.

SECTION 2 - LIMITATIONS

- A. Display of TIS traffic information is advisory only and does not relieve the pilot responsibility to "see and avoid" other aircraft. Aircraft maneuvers shall not be predicated on the TIS displayed information.
- B. Display of TIS traffic information does not constitute a TCAS I or TCAS II collision avoidance system as required by 14 CFR Part 121 or Part 135.
- C. Title 14 of the Code of Federal Regulations (14 CFR) states that "When an Air Traffic Control (ATC) clearance has been obtained, no pilot-in-command (PIC) may deviate from that clearance, except in an emergency, unless he obtains an amended clearance." Traffic information provided by the TIS up-link does not relieve the PIC of this responsibility.
- D. The 400/500 Series Garmin Display Interfaces (Pilot's Guide Addendum) P/N 190-00140-13 Rev. A or later revision must be accessible to the flight crew during flight.
- E. 400/500 Series Main Software 4.00 or later FAA approved software is required to operate the TIS interface and provide TIS functionality.

SECTION 3 - EMERGENCY PROCEDURES

To transmit an emergency signal:

- Mode Selection Key - ALT
- Code Selection - SELECT 7700

To transmit a signal representing loss of all communications:

- Mode Selection Key - ALT
- Code Selection - SELECT 7600

SECTION 4 - NORMAL PROCEDURES**BEFORE TAKEOFF:**

- To transmit Mode C (Altitude Reporting) code in flight:
- Mode Selection Key - ALT
- Code Selector Keys - SELECT assigned code.

To transmit Mode A (Aircraft Identification) code in flight:

- Mode Selector Key - ON
- Code Selector Keys - SELECT assigned code.

NOTE

During normal operation with the ON mode selected, the reply indicator "R" flashes, indicating transponder replies to interrogations.

NOTE

Mode A reply codes are transmitted in ALT also; however, Mode C codes only are suppressed when the Function Selector ON key is selected.

1. DETAILED TRANSPONDER OPERATING PROCEDURES

Normal transponder operating procedures are described in the GARMIN GTX 330 Pilot's Guide, P/N 190-00207-00, Rev. A, or later appropriate revision.

2. DISPLAY OF TRAFFIC INFORMATION SERVICE (TIS) DATA

TIS surveillance data uplinked by Air Traffic Control (ATC) radar through the GTX 330 Mode S Transponder will appear on the interfaced display device (Garmin 400 or 500 series products). For detailed operating instructions and information regarding the TIS interface, refer to the 400/500 Series Garmin Display Interfaces (Pilot's Guide Addendum) P/N 190-00140-13 Rev. A or later appropriate revision.

SECTION 5 - PERFORMANCE

No change.

SECTION 6 - WEIGHT AND BALANCE

Factory installed optional equipment is included in the licensed weight and balance data in section 6 of the Airplane Flight Manual.

SECTION 7 - DESCRIPTION AND OPERATION

See the 400/500 Series Garmin Display Interfaces (Pilot's Guide Addendum), P/N 190-00140-13, and GTX 330 Pilot's Guide, P/N 190-00207-00, for a complete description of the GTX 330 system.

**PILOT'S OPERATING HANDBOOK
AND
FAA APPROVED AIRPLANE FLIGHT MANUAL**

**SUPPLEMENT NO. 20
FOR
AVIDYNE FLIGHTMAX ENTEGRA
PRIMARY FLIGHT/MULTI-FUNCTION DISPLAYS**

This supplement must be attached to the Pilot's Operating Handbook and FAA Approved Airplane Flight Manual when the optional Avidyne FlightMax Entegra Primary Flight and Multi-Function Displays are installed per the Equipment List. The information contained herein supplements or supersedes the basic Pilot's Operating Handbook and FAA Approved Airplane Flight Manual only in those areas listed herein. For limitations, procedures and performance information not contained in this supplement, consult the Pilot's Operating Handbook and FAA Approved Airplane Flight Manual.

FAA APPROVED:



LINDA J. DICKEN
DOA-510620-CE
THE NEW PIPER AIRCRAFT, INC.
VERO BEACH, FLORIDA

DATE OF APPROVAL: OCTOBER 7, 2004.

ISSUED: JULY 12, 1995
REVISED: JANUARY 9, 2006

REPORT: VB-1611
1 of 30, 9-1111

FUNCTION 1 - GENERAL

This airplane is equipped with the Avidyne FlightMax Entegra EXP5000 series 700-00006-0XX-() Primary Flight Display with software to the latest revision per Avidyne website and EX5000 series 700-00004-0XX-() Multi-Function Display with software to the latest revision per Avidyne website, herein referred to as the "PFD" and "MFD". The PFD is intended to be the primary display of primary flight and essential engine parameter information to the pilot. The PFD is capable of interfacing with a pair of Garmin GNS 430/530's, and an S-TEC System 55X autopilot.

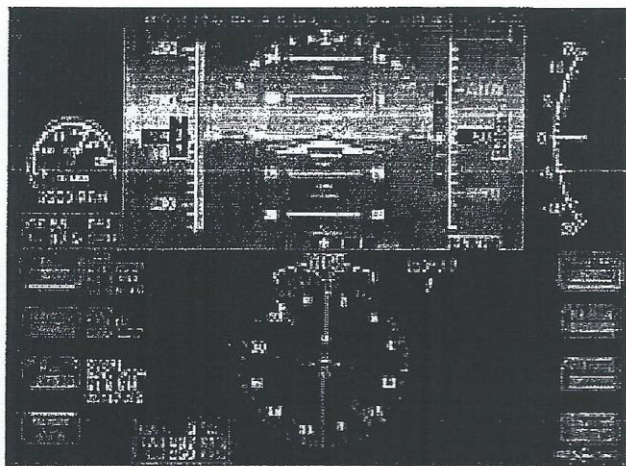

Figure 1 - Entegra 700-00006-0XX-() Primary Flight Display

The PFD provides the display of the following aircraft parameters:

- Artificial Horizon
- Airspeed Indication
- Altimeter
- Vertical Speed Indication
- Rate of Turn Indicator
- Skid/Slip Indicator
- Horizontal Situation Indication
- RMI
- Course Deviation Indication
- Outside Air Temperature
- Engine RPM
- Fuel Flow
- Oil Pressure
- Autopilot Annunciation

SECTION 1 - GENERAL (continued)

The MFD is intended to be a supplemental display of situational and navigation information to the pilot. Its primary function is to provide a moving map display to the pilot for increased situational awareness. The MFD is capable of accepting data from a variety of GPS sensors, the BFG WX-500 Stormscope passive thunderstorm detection unit, Engine Sensor Unit, and either the L3 Skywatch Traffic Advisory System (TAS), Bendix/King TAS, or the Ryan Traffic and Collision Alert Device (TCAD) system. The unit is organized around logical groupings of information presented on “Pages”.

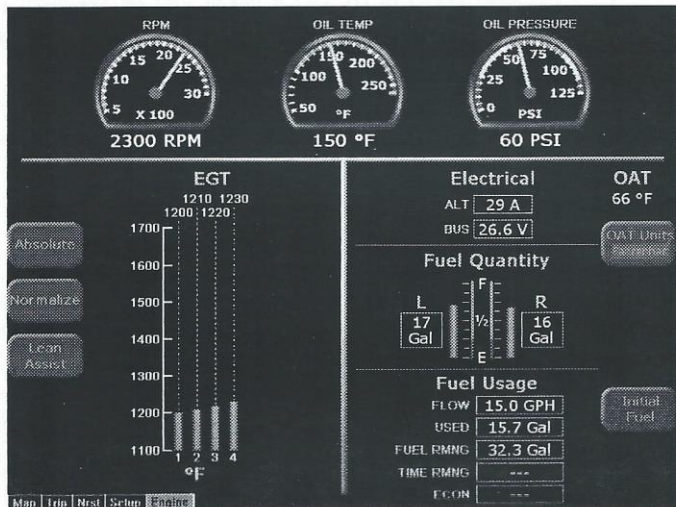

Figure 2 - EX5000 series 700-00004-0XX-() Multi-Function Display

The MFD provides the display of the following aircraft parameters:

- Engine RPM
- Engine Oil Temperature
- Engine Oil Pressure
- EGT
- Cylinder Head Temperature
- Aircraft Electrical Status
- Outside Air Temperature
- Fuel Quantity
- Fuel Usage Data

SECTION 2 - LIMITATIONS

A. PFD Limitations

1. IFR flight is prohibited when the PFD or any standby instrument is inoperative (altimeter, airspeed indicator, artificial horizon, or whiskey compass).
2. IFR flight is prohibited upon aircraft total loss of essential engine parameter display (manifold pressure, tachometer, fuel flow).
3. The Avidyne FlightMax Entegra series Primary Flight Display Pilot's Guide, p/n 600-00104-000 revision 00 or appropriate later revision, or p/n 600-00143-000 revision 01 (EXP 5000 R6) or appropriate later revision, must be available to the pilot during all flight operations.
4. If a VOR or Localizer (VLOC) navigation source is displayed on the HSI and GPSS mode is engaged on the autopilot, the autopilot will track the active flight plan in the GPS corresponding to the selected VLOC source selected for display on the HSI (i.e. GPS1 for VLOC1 or GPS2 for VLOC2). This configuration is potentially confusing and must be avoided.
5. GPSS mode must not be used on the final approach segment of a VLOC approach (ILS, LOC or non-GPS-overlay VOR). GPSS mode must be deselected (i.e., NAV mode selected) prior to the turn onto the final approach course.

NOTE

The PFD integrates with separately approved sensor and flight control installations. Adherence to limitations in appropriate installation AFM supplements is mandatory.

B. MFD Limitations

1. The Avidyne moving map display provides visual advisory of the airplane's GPS position against a moving map. This information supplements CDI course deviation and information presented on the GPS navigator. The moving map display must not be used as the primary navigation instrument.
2. Use of Map page during IFR flight requires an IFR approved GPS receiver and installation, operated in accordance with its applicable limitations.
3. The Avidyne FlightMax EX-series Pilot's Guide, p/n 600-00105-000 revision 00 or appropriate later revision, must be available to the pilot during all flight operations.

SECTION 2 - LIMITATIONS (continued)**B. MFD Limitations (continued)**

4. Aircraft dispatch is prohibited when the MFD is inoperative.
5. Selecting "Lightning Display OFF" for the Lightning overlay of the Map page will prevent current heading values from being sent to the WX500 sensor from the EX5000.

When "Lightning Display OFF" is selected the EX5000 will stop sending current heading values to the WX500. When this selection is made, the WX500 will still use the last heading value that was present before this selection even though the actual aircraft heading may have changed since that selection was made.

Consequently, the Stormscope heading information provided to the Garmin 430 by the EX5000 will not be updated, resulting in an inaccurate lightning depiction on the Garmin 430. This issue does not affect the lightning display on the EX5000.

To avoid this invalid condition, **disable the WX500 on the GNS430**. For instructions on how to accomplish this, refer to the Garmin 400 Series Installation Manual, p/n 190-00140-02, latest revision (reference Section 5.1 Configuration Mode Operations, Section 5.2 Installation Configuration pages, and Section 5.2.2 Main RS232 Configuration page).

CAUTION

Traffic information shown on the Map page display is provided to the pilot as an aid to visually acquiring traffic. Pilot's should maneuver their aircraft based only on ATC guidance or positive visual acquisition of the conflicting traffic. Maneuvers should be consistent with ATC instructions. No maneuvers should be based only on a Traffic Advisory.

Terrain information shown on the Map page display is provided to the pilot as an aid to situational awareness. The Map page terrain color representations should not be used as a basis for terrain avoidance.

NOTE

The MFD integrates with separately approved sensor and flight control installations. Adherence to limitations in appropriate installation AFM supplements is mandatory.

SECTION 2 - LIMITATIONS (continued)

C. CMAX CHART PAGE Limitations

The geographic referenced aircraft symbol must not be used for navigation.

NOTE

The aircraft symbol displayed provides supplemental aircraft situational awareness information. It is not intended as a means for navigation or flight guidance. The airplane symbol is not to be used for conducting instrument approaches or departures. Position accuracy, orientation, and related guidance must be assumed by other means or required navigation.

Operators with the optional CMax Chart Page must have back-up charts available. Do not rely upon CMax charts as your sole source of navigation information.

THIS PAGE INTENTIONALLY LEFT BLANK

SECTION 3 - EMERGENCY PROCEDURES

Failure of Pilot's Electronic Attitude Direction Display Screen (PFD)

Indication: PFD Display goes blank.

Standby Attitude Gyro**VERIFY ON** and
~~flag is pulled on gyro~~

Maintain attitude control using standby gyro and establish the aircraft in straight and level unaccelerated flight.

If time and conditions permit:

PFD Brightness Control (BRT/DIM)Run to full bright

PFD Circuit BreakerPULL and RESET

If PFD Screen cannot be reinstated:

On aircraft equipped with the optional second Nav Indicator (OBS):

Mechanical Nav Indicator (OBS).....Utilize for primary navigation

Engine Instruments.....Refer to Engine page of MFD

NOTE

The Mechanical Nav Indicator (OBS) receives nav information directly from the No. 2 nav/com/GPS. Only VLOC information is available.

Maintain attitude, airspeed and heading control using standby instruments, magnetic compass and other directional indications (such as MFD, MAP/NAV page).

CAUTION

High current loads in the vicinity of the magnetic compass can influence its accuracy. Depending on the flight conditions, the pilot must reduce these loads as much as possible to insure accuracy. Tests have shown that air conditioner and pitot heat contribute to significant heading errors of the magnetic compass. These items should be turned OFF prior to comparing magnetic compass headings.

Land as soon as practical.

SECTION 3 - EMERGENCY PROCEDURES (continued)

Loss of PFD Engine Data

Indication: Indicator needle removed from dial and digital readout replaced with white dashes.

Engine Instruments.....Refer to Engine page of MFD
Land as soon as practical.

Invalid Air Data

Indication: Airspeed, Altimeter, and Vertical Speed data replaced with Red X's.

Maintain aircraft airspeed and altitude by referring to the standby airspeed and altimeter.

If time and conditions permit:

PFD Circuit BreakerPULL and RESET

If air data is still invalid:

Refer to standby airspeed indicator and altimeter.

Land as soon as practical.

Invalid Heading Data

Indication: Heading Bug and Heading Data removed and replaced with Red X's.

If time and conditions permit:

PFD Circuit BreakerPULL and RESET

Maintain heading control using magnetic compass and other directional indications (such as MFD, MAP/NAV page).

CAUTION

High current loads in the vicinity of the magnetic compass can influence its accuracy. Depending on the flight conditions, the pilot must reduce these loads as much as possible to insure accuracy. Tests have shown that air conditioner and pitot heat contribute to significant heading errors of the magnetic compass. These items should be turned OFF prior to comparing magnetic compass headings.

Land as soon as practical.

SECTION 3 - EMERGENCY PROCEDURES (continued)

Invalid Attitude and Heading Data

Indication: Attitude and Heading Data removed and replaced with Red X's.

Standby Attitude GyroVERIFY ON and
flag is pulled on gyro.

Maintain attitude control using standby gyro.

If time and conditions permit:

PFD Circuit BreakerPULL and RESET

If attitude and heading data is still invalid:

Maintain attitude control by using standby gyro.

Maintain heading control by utilizing magnetic compass and other directional indications (such as MFD, MAP/NAV page).

CAUTION

High current loads in the vicinity of the magnetic compass can influence its accuracy. Depending on the flight conditions, the pilot must reduce these loads as much as possible to insure accuracy. Tests have shown that air conditioner and pitot heat contribute to significant heading errors of the magnetic compass. These items should be turned OFF prior to comparing magnetic compass headings.

Land as soon as practical.

SECTION 3 - EMERGENCY PROCEDURES (continued)

Failure of Attitude, Airspeed and Heading Reference System (ADAHRS)

Indication: Airspeed, Attitude, Heading and Altitude replaced with Red X's.

Standby Attitude GyroVERIFY ON and
flag is pulled on gyro

Maintain attitude control using standby gyro.

If time and conditions permit:

PFD Circuit BreakerPULL and RESET

If ADAHRS initialization does not occur:

On aircraft equipped with the optional second Nav Indicator (OBS):

Mechanical Nav Indicator (OBS).....Utilize for primary navigation

Engine Instruments.....Refer to Engine page of MFD

NOTE

The Mechanical Nav Indicator (OBS) receives nav information directly from the No. 2 nav/com/GPS. Only VLOC information is available.

Maintain attitude, airspeed and heading control using standby instruments, magnetic compass and other directional indications (such as MFD, MAP/NAV page).

CAUTION

High current loads in the vicinity of the magnetic compass can influence its accuracy. Depending on the flight conditions, the pilot must reduce these loads as much as possible to insure accuracy. Tests have shown that air conditioner and pitot heat contribute to significant heading errors of the magnetic compass. These items should be turned OFF prior to comparing magnetic compass headings.

Land as soon as practical.

SECTION 3 - EMERGENCY PROCEDURES (continued)

Cross Check Monitor

Indication: Yellow Crosscheck Attitude Annunciator on PFD.

Establish aircraft in straight and level unaccelerated flight.

Aircraft Attitude Crosscheck aircraft attitude
with standby attitude gyro

Total Loss of Engine Instruments

Indication: Indicator needle removed from dial and digital readout replaced with white dashes.

DAU Circuit BreakerPULL and RESET

If engine data is still invalid:

NOTE

The following engine messages will be displayed on the MFD if an exceedance is detected:

- Check Oil Temp
- Check Oil Press
- Check CHT
- Check RPM
- Check EGT

If failure occurs during takeoff:

MixtureMaintain full rich

ThrottleFull power

Return to airport for landing.

If failure occurs during climb or landing:

MixtureMaintain full rich

Throttle.....As required

Land as soon as practical.

If failure occurs after setting cruise power and mixture:

PowerMaintain power setting

Land as soon as practical.

If failure occurs prior to or during descent:

MixtureFull rich

ThrottleSet for 500 feet per minute
descent at 122 KIAS

SECTION 3 - EMERGENCY PROCEDURES (continued)

Alternator Failure

Indication: Alternator Inop annunciator light illuminated and zero current displayed on MFD alternator indication source.

NOTE

Anytime the bus voltage is below 25 Vdc, the Low Bus Voltage annunciator will be illuminated.

Verify Failure.....Check ammeter

If ammeter shows zero:

ALTR switchOFF

Reduce electrical load to minimum:

ALTNR FIELD C/BCHECK and RESET as required

ALTR SwitchON

WARNING

Compass error may exceed 10 degrees with alternator inoperative.

CAUTION

Any power interruption will result in loss of attitude information from the PFD until the unit can be reinstated on the ground.

NOTE

Consider using the autopilot to reduce workload. Using the GPSS mode can assist in maintaining a flight-planned route.

NOTE

LO BUS VOLTAGE annunciator will be illuminated. Anticipate complete electrical failure. Duration of battery power available will be dependent on electrical load and battery condition prior to failure.

SECTION 3 - EMERGENCY PROCEDURES (continued)

Alternator Failure (continued)

If power is not restored:

ALTR Switch.....OFF

Reduce electrical loads by switching OFF or pulling circuit breakers for all non-essential equipment to include the following:

- Reduce PFD and MFD brightness as part of overall electrical system management
- Pitot heat (unless required)
- Airconditioner and ventilation fan (if installed)
- Landing light (use sparingly)
- Strobe lights
- Recognition lights (if equipped)
- Cabin/flood lights
- No. 2 nav/com/GPS
- Autopilot
- Electric trim
- DME (unless required for published approach)
- Stormscope (if equipped)
- Skywatch (if equipped)

Land as soon as practical.

SECTION 3 - EMERGENCY PROCEDURES (continued)

Complete Electrical Failure

Standby Attitude GyroSELECT Standby (STBY) power button

CAUTION

The STBY PWR annunciator will rapidly flash for approximately one minute when aircraft power is lost. STBY PWR must be selected, otherwise the gyro will auto shutdown after approximately one minute.

Standby Attitude GyroVERIFY ON and
flag is pulled on gyro

Maintain aircraft control with reference to the standby airspeed, altimeter, and attitude gyro indicators.

Battery SwitchOFF

Land as soon as possible.

WARNING

Compass error may exceed 10 degrees with alternator inoperative.

SECTION 3 - EMERGENCY PROCEDURES (continued)

Fire in Flight

Electrical Fire

Fire.....Extinguish
Standby Attitude Gyro**VERIFY ON** and
flag is pulled on gyro

Maintain aircraft control with reference to the standby airspeed, altimeter, and attitude gyro indicators.

Battery Master Switch.....OFF
ALTR Switch.....OFF
VentsOPEN
Cabin Heat.....OFF

Land as soon as practical.

WARNING

Compass error may exceed 10 degrees with alternator inoperative.

SECTION 3 - EMERGENCY PROCEDURES (continued)

Aircraft Engine Power Loss

During an engine failure the pilot may elect to attempt an engine restart. During this time large voltage drops may cause the PFD to lose power and reinitialize. During this initialization process the PFD may not be able to complete a fast alignment during flight and therefore the pilot may have to obtain aircraft attitude and aircraft control using the standby instruments.

- Refer to the Emergency Section of the Pilot's Operating Handbook.
- If the PFD is able to perform fast alignment, when prompted by the PFD:
 - Maintain straight and level flight

OR

- If engine does not restart, maintain wings level and appropriate aircraft speed.
- Press the fast erect button.
- If the PFD was not able to perform fast alignment, maintain aircraft control with reference to the standby instruments for aircraft attitude information.

CAUTION

In case of engine failure, minimize the use of the starter and turn off all non-essential electrical equipment to preserve battery capacity.

Loss of Fuel Flow

Electric Fuel PumpON
 Fuel SelectorCheck on tank containing usable fuel

Engine Driven Fuel Pump Failure

ThrottleRETARD
 Electric Fuel PumpON
 Throttle.....RESET as required

CAUTION

If normal engine operation and fuel flow is not immediately re-established, the electric fuel pump should be turned OFF. The lack of fuel flow indication while the electric pump is on could indicate a leak in the fuel system or fuel exhaustion. If fuel system leak is verified, switch fuel selector to OFF.

SECTION 3 - EMERGENCY PROCEDURES (continued)

Loss of Heading Accuracy

Indication:

- Difficulty maintaining course while using VOR or GPS.
- Excessive difference between heading and track required maintaining a VOR or GPS course.
- ATC indicates the aircraft is on a wrong heading.
- Excessive deviation between PFD heading and Whiskey Compass. (>10° after compass deviation applied.)

If heading systems differ by more than 10° (after compass deviation applied):

- Use Whiskey Compass for primary heading reference.

CAUTION

High current loads in the vicinity of the Whiskey Compass can influence its accuracy. Depending on the flight conditions, the pilot must reduce these loads as much as possible to insure accuracy. Tests have shown that air conditioner and pitot heat contribute to significant heading errors of the Whiskey Compass. These items should be turned OFF prior to comparing the Whiskey Compass to the PFD heading.

SECTION 4 - NORMAL PROCEDURES

Engine Start - General

CAUTION

Do not attempt flight if there is no indication of alternator output.

CAUTION

If a positive oil pressure is not indicated within 30 seconds following an engine start, stop the engine and determine the trouble. In cold weather it will take a few seconds longer to get a positive oil pressure indication.

NOTE

Starter manufacturers recommend that starter cranking periods be limited to 30 seconds with a two minute rest period between cranking periods. Longer cranking periods will shorten the life of the starter.

Before Starting Engine

- PassengersBOARD
- DoorCLOSE and LATCH
- SeatsADJUSTED and LOCKED in position
- Seat Belts and HarnessesFASTEN/ADJUST
- BrakesSET
- Circuit Breakers.....Check IN
- Alternate AirOFF
- PropellerFull INCREASE rpm
- Fuel SelectorDesired tank

SECTION 4 - NORMAL PROCEDURES (continued)

Normal Start - Cold Engine

Throttle½ inch open
Battery Master Switch.....ON
Primary Flight Display (PFD)Verify correct aircraft
model software
Alternator SwitchON
Electric Fuel PumpON
Magneto SwitchesON
Mixture.....Prime - then idle cut-off
Propeller.....CLEAR
StarterENGAGE
Mixture.....Full RICH
Throttle.....ADJUST
Oil PressureCHECK

Normal Start - Hot Engine

Throttle½ inch open
Battery Master Switch.....ON
Primary Flight Display (PFD)Verify correct aircraft
model software
Alternator SwitchON
Electric Fuel PumpON
Magneto SwitchesON
MixtureIdle cut-off
Propeller.....CLEAR
StarterENGAGE
Mixture.....ADVANCE
Throttle.....ADJUST
Oil PressureCHECK

SECTION 4 - NORMAL PROCEDURES (continued)

Engine Start When Flooded

Throttle	Open full
Battery Master Switch.....	ON
Primary Flight Display (PFD)	Verify correct aircraft model software
Alternator Switch	ON
Electric Fuel Pump	OFF
Magneto Switches	ON
Mixture	Idle cut-off
Propeller.....	CLEAR
Starter	ENGAGE
Mixture	Full rich
Throttle	RETARD
Oil Pressure	CHECK

SECTION 4 - NORMAL PROCEDURES (continued)

Starting With External Power Source

CAUTION

It is possible to use the ship's battery in parallel by turning only the battery master switch ON. This will give longer cranking capabilities, but will not increase the amperage. Care should be exercised because if the ship's battery has been depleted, the external power supply can be reduced to the level of the ship's battery. This can be tested by turning on the battery master switch momentarily while the starter is engaged. If cranking speed increases, the ship's battery is at a higher level than the external power supply.

NOTE

For all normal operations using external power, the battery master and alternator switches should be OFF.

Battery Master SwitchOFF
Alternator Switch.....OFF
Magneto SwitchesON
All Electrical Equipment.....OFF
External Power PlugInsert in fuselage
Proceed with normal start checklist
ThrottleLowest possible RPM
External Power PlugDisconnect from fuselage
Battery Master Switch.....ON
Alternator SwitchON - check ammeter
Oil PressureCHECK

SECTION 5 - PERFORMANCE

No change from basic Handbook.

SECTION 6 - WEIGHT AND BALANCE

No change from basic Handbook.

SECTION 7 - DESCRIPTION AND OPERATION**A. PFD Systems Description****NOTE**

This supplement provides a general description of the Avidyne FlightMax Entegra Series 700-00006-0XX-() PFD, its operation, and aircraft systems interfaces. For a detailed description of PFD operation, refer to the Avidyne FlightMax Entegra Series Primary Flight Display Pilot's Guide, p/n 600-00104-000 revision 00 or appropriate later revision, or 600-00143-000 revision 01 (EXP 5000 R6) or appropriate later revision.

The Entegra PFD start-up is automatic once power is applied. The display presents the Initialization Display immediately after power is applied. Power-on default is 75% brightness. Typical alignment times are 3 minutes once power is applied.

Attitude Direction Indicator (ADI)Air Data

The airspeed tape to the left of the main ADI begins indicating at 20 Knots Indicated Airspeed (IAS) and is color coded in accordance with the model POH airspeeds for V_{SO} , V_{FE} , V_s , V_{NO} , and V_{NE} . An altitude tape is provided to the right of the main ADI and also displays a symbol for the Altitude Preselect (Altitude Bug). The Vertical Speed Indicator (VSI) is displayed to the right of the altitude tape. For vertical speed rates greater than the PFD displayed VSI scale, the indicator needle will peg just outside the scale and a digital readout of actual VSI up to 4000 FPM is then displayed. An additional data block is provided for display of Outside Air Temperature (OAT), True Airspeed (TAS), and Ground Speed (GS). Controls for selecting bug and barometric correction values are along the right side of the PFD. A wind indicator is also provided beneath the altitude tape.

Attitude Data

Attitude is depicted on the main ADI using a combination of an aircraft reference symbol ("flying-delta") against a background of labeled pitch ladders for pitch and a bank angle pointer in the form of an arced scale along the top of the main ADI for bank. A skid/slip indicator is attached to the bottom edge of the bank angle pointer.

SECTION 7 - DESCRIPTION AND OPERATION (continued)

A. PFD Systems Description (continued)

Horizontal Situation Indicator (HSI)

Heading Data

Magnetic heading is represented in a boxed digital form at the top of the compass rose. Heading rate (Rate of Turn Indicator) takes the form of a blue arcing arrow that begins behind the magnetic heading indicator and moves left or right accordingly. Graduations are provided on the rate of turn indicator scale to indicate $\frac{1}{2}$ and full standard rate turns. A heading bug is also provided on the compass rose.

Navigation Data

Navigation data on the PFD takes several forms. A Course Deviation Indicator (CDI) is always provided on the HSI and a bearing pointer can be optionally selected for display on the HSI by the pilot. Controls for selecting the source of navigation data, selecting the display format of the navigation data, and for selecting the type of compass rose and moving map to be displayed are along the left side of the PFD. The active flight plan contained in the GPS Nav/Comm unit selected as the primary navigation source (Nav) can be optionally selected for display on the HSI as well as the desired range of the optionally selectable moving map display. If a localizer or ILS frequency is tuned and captured in the GPS Nav/Comm selected as the Nav source, a Vertical Deviation Indicator (VDI) and Horizontal Deviation Indicator (HDI) are automatically displayed on the ADI.

While executing an ILS or localizer only approach, the course deviation indicator (CDI) and glideslope needles on the PFD, as appropriate, may exhibit a slight oscillatory motion. The oscillatory motion increases from zero amplitude at approximately 2500 rpm to approximately $\frac{1}{2}$ dot total amplitude at 2700 rpm. The GI-106 mechanical VOR Indicator needles exhibit this same behavior, only to a lesser degree. The pilot should fly the "average" localizer/glideslope needle position or decrease engine rpm to reduce needle oscillation.

NOTE

In the event glide slope or localizer signals are lost, the HDI and/or VDI will be displayed as red X's to indicate loss of signal. The red X'd indicator will only be removed if the signal is regained. In this case, the PFD Nav source will set to GPS, or if the GPS Nav/Comm is retuned, to another frequency. Appropriate action must be taken by the pilot if on an approach.

SECTION 7 - DESCRIPTION AND OPERATION (continued)**A. PFD Systems Description (continued)****Autopilot Integration**

The Entegra PFD is fully integrated with the S-TEC System 55X Autopilot. Reference bugs for Heading, Altitude, and Vertical Speed are provided on the PFD to control the autopilot and aid pilot situational awareness. These bugs are displayed with solid or hollow symbology depending on the autopilot status. If the autopilot is engaged in that mode, the bug is solid to indicate the autopilot is coupled to that bug. A hollow bug indicates the autopilot is not engaged in that mode.

Autopilot mode annunciations are shown on the S-TEC System 55X computer. When included as part of the installation, autopilot mode annunciations including autopilot ready and fail indications are provided at the top of the PFD screen.

When included as part of the installation, flight director command bars on the PFD attitude indicator can be enabled by the pilot. When the flight director is enabled and the autopilot is engaged in both lateral and vertical modes, the flight director displays the goals of the autopilot.

A lateral autopilot mode must be engaged on the S-TEC System 55X before a vertical mode can be engaged.

The flight director command bars will only be displayed on the PFD when enabled by the pilot and when both lateral and vertical autopilot modes are engaged.

SECTION 7 - DESCRIPTION AND OPERATION (continued)

A. PFD Systems Description (continued)

Autopilot Integration (continued)

The following autopilot modes are supported by the PFD:

1. HDG (Heading, using the heading bug)
2. NAV (Nav, using the course pointer and course deviation indicator)
3. GPSS (GPS Steering, using GPS course guidance)
4. APR (Approach, using the HDI and VDI, including automatic glide slope capture)
5. REV (Reverse sensing HDI approach)
6. ALT (Altitude Hold and Preselect, using the altitude bug)
7. VS (Vertical Speed, using the vertical speed bug)

NOTE

When HDG mode is engaged, rotation of the heading bug greater than 180° will result in a reversal of turn direction.

CAUTION

If a VLOC is selected in NAV on the PFD and GPSS mode is engaged on the autopilot, the autopilot will track the active flight plan in GPS1 if VLOC1 is selected or GPS2 if VLOC2 is selected and not track VLOC1 or VLOC2 as the selected source in NAV on the PFD. Therefore, the course deviation on the PFD CDI and the course deviation flown by the autopilot can be different. This situation may be confusing and should be avoided.

Engine Instruments

The Entegra PFD provides a display of Engine Tachometer (RPM), Oil Pressure (OP), and Fuel Flow (FF) in the upper left hand corner of the display. Tach indications are presented on analog scales with normal operating (green) and warning (red) markings, as appropriate. A digital indication presents fuel flow information in gallons per hour (GPH). A digital indication presents oil pressure information in pounds per square inch (PSI).

SECTION 7 - DESCRIPTION AND OPERATION (continued)

A. PFD Systems Description (continued)

Back-up Instruments

The Entegra PFD system installation includes redundant means of display of certain aircraft flight and systems parameters. Back-up Altimeter, Airspeed and Attitude instruments are provided to facilitate pilot cross-checking of PFD display flight parameters. The aircraft wet compass serves as a back-up heading source.

THIS SPACE INTENTIONALLY LEFT BLANK

SECTION 7 - DESCRIPTION AND OPERATION (continued)

B. MFD Systems Description

NOTE

This supplement provides a general description of the Avidyne EX5000 Series 700-00004-0XX-() MFD, its operation and aircraft interface. For a detailed description of the MFD, refer to the Avidyne FlightMax EX5000 Series Pilot's Guide and Reference, p/n 600-00105-000 revision 00 or later.

Navigation

Data associated with the moving map is found on four pages: Map, Nearest, Trip, and Info pages. The MFD contains a Jeppesen NavData database that is available for display on the Map page. In conjunction with GPS-supplied position information, an own-ship symbol is superimposed on the moving map and positioned relative to the NavData information. GPS can also supply the active flight plan for display on the moving map. Terrain data is provided by a USGS terrain database stored within the MFD and updated only on an as needed basis.

The Jeppesen Navigation Database provides data on airports, approaches, VOR's, NDB's, intersections, airspace definitions, and frequencies. North American and international databases are available. Database information can be updated via the USB port on the front face of the bezel.

The navigation data on the moving map display are based on databases that are updated periodically. Database updates are available on 28-day cycle subscriptions. Expired databases are clearly stated to the pilot via messages during system startup and on the System Setup page. The warning can only be removed by updating the data.

NOAA man-made obstruction database information provides data on man-made obstacles over 200 feet AGL. This data is only available for North America and can be updated via the USB port on the front face of the bezel.

The obstacle data on the moving map display are based on databases that are updated periodically. Database updates are available from Avidyne on 56-day cycle subscriptions. Expired databases are clearly stated to the pilot via messages during system startup and on the System Setup page. The warning can only be removed by updating the data.

SECTION 7 - DESCRIPTION AND OPERATION (continued)**B. MFD Systems Description (continued)****Navigation (continued)**

Using the Jeppesen NavData data and the GPS-supplied present position, the MFD can provide the pilot with the nearest 25 airports or nav aids, depending on pilot selection, within 100 nm. This information is presented on the Nearest page.

More detailed information on a particular airport is also generated from the Jeppesen NavData data and is available for pilot viewing on the Info page.

Flight plan data supplied by the GPS system provide the pilot with a tabular form of the remaining legs in the active GPS flight plan. This information is viewed on the Trip page and includes a CDI for added enroute navigation aiding.

Flight plan data is transmitted to the MFD from an external GPS navigator. Some installations do not support depictions of curved flight paths. In these cases, curved flight path segments will be depicted as straight lines. The GPS navigator and HSI are to be used during approach procedures. Reference the Avidyne FlightMax EX5000 Series Pilot's Guide, p/n 600-00105-000, for more information.

Datalink

Datalink information is received by the MFD based upon installation provisions and a subscription service available through Avidyne (www.myavidyne.com). Data is presented on the Map, Trip, and Nearest pages. Datalink information is provided for strategic planning purposes only. Data aging and transport considerations make it unsuitable for tactical use. Reference the Avidyne FlightMax EX5000 Series Pilot's Guide, p/n 600-00105-000, for more information.

Setup

The various System Setup pages allow the pilot to set user preferences for system operation. In addition to listing the software version identification information and database validity dates, the System Setup page allows access to several pages for preference selection and provides a means to initiate self-tests of the traffic and lightning sensors.

SECTION 7 - DESCRIPTION AND OPERATION (continued)

B. MFD Systems Description (continued)

Setup (continued)

Airport Settings page provides selections for displaying airport type, runway surface type and minimum runway lengths on the moving map. **Declutter Settings** page allows the pilot to select settings for defining the base map detail when changing display range. **System Time** page provides an opportunity to select system time zone and Map page menu timeout options. **DataBlock Edit** page allows the pilot to select the data to be displayed in the datablock windows on the Map page. **Datalink Setup** page allows the pilot to select parameters for the datalink system, including update rate and range of weather data request.

Engine Instruments

The Engine page provides the pilot with engine parameters depicted on simulated gauges and electrical system parameters located in dedicated regions within the MFD display. An Engine Sensor Unit interfaces with engine-mounted sensors and provides data to the MFD for display.

A leaning function assists the pilot in leaning the engine for best power or best fuel economy. To initiate the leaning function, press the Lean Assist bezel key and proceed to lean the engine fuel mixture. Best economy is achieved when the engine is operating at peak EGT of the leanest cylinder (first cylinder to peak), as recommended by the engine manufacturer. Best power is achieved when the engine is leaned to the first cylinder to reach its EGT peak. When leaning is complete, select Absolute or Normalize to complete the leaning process. A digital readout of EGT change from the peak value is provided for reference. Reference the Avidyne FlightMax EX5000 series Pilot's Guide, p/n 600-00105-000, for more information.

**PILOT'S OPERATING HANDBOOK
AND
FAA APPROVED AIRPLANE FLIGHT MANUAL**

**SUPPLEMENT NO. 21
FOR
MID-CONTINENT 4300-4XX SERIES
ELECTRIC ATTITUDE INDICATOR**

This supplement must be attached to the Pilot's Operating Handbook and FAA Approved Airplane Flight Manual when the optional Mid-Continent 4300-4XX Series Electric Attitude Indicator is installed per the Equipment List. The information contained herein supplements or supersedes the basic Pilot's Operating Handbook and FAA Approved Airplane Flight Manual only in those areas listed herein. For limitations, procedures and performance information not contained in this supplement, consult the Pilot's Operating Handbook and FAA Approved Airplane Flight Manual.

FAA APPROVED:



LINDA J. DICKEN
DOA-510620-CE
THE NEW PIPER AIRCRAFT, INC.
VERO BEACH, FLORIDA

DATE OF APPROVAL: OCTOBER 7, 2004

ISSUED: JULY 12, 1995
REVISED: SEPTEMBER 12, 2005

REPORT: VB-1611
1 of 4, 9-139

SECTION 1 - GENERAL

This supplement supplies information necessary for the operation of the airplane when the optional Mid-Continent model 4300-XXX Electric Attitude Indicator is installed in accordance with FAA Approved Piper data. For additional information refer to the Mid-Continent Instruments Pilot's Guide, manual number 9015834, revision NR, or later revision.

SECTION 2 - LIMITATIONS

1. The emergency battery must be checked for proper operation prior to flight.
2. Should the RED TEST annunciator illuminate any time during the self test, this is an indication that the battery pack is in need of charging, or possible replacement. Flight in Instrument Meteorological Conditions (IMC) is prohibited.
3. Internal battery should be used for emergency use only.

SECTION 3 - EMERGENCY PROCEDURES

Loss of Aircraft Electrical System

Standby (STBY) Power Button.....SELECT

CAUTION

The STBY PWR annunciator will rapidly flash for approximately one minute when aircraft power is lost. STBY PWR must be selected, otherwise the gyro will auto shutdown after approximately one minute.

Maintain attitude control using standby gyro.

SECTION 4 - NORMAL PROCEDURES

Preflight Check

1. Apply aircraft power and allow the gyro to spin up for approximately 2 minutes.
2. Press and hold the STBY PWR button.
3. Verify that after several seconds the amber LED has started to flash. This indicates that the unit has latched into the Battery Test Mode. At this time the STBY PWR button can be released.
4. Verify that a green annunciator is illuminated under the word TEST.
5. Visually monitor the test lights until the amber LED stops flashing, signaling the end of the test.

NOTE

A green annunciator throughout the test indicates the standby battery is sufficiently charged and should be able to function under normal operation. The presence of a red annunciator at any time during the test is an indication the standby battery is in need of charging, or possibly replacement.

NOTE

The Standby Attitude Indicator will operate for approximately one hour with the internal battery, depending on battery condition at the time of power failure.

SECTION 5 - PERFORMANCE

No change.

SECTION 6 - WEIGHT AND BALANCE

Factory installed optional equipment is included in the licensed weight and balance data in Section 6 of the Airplane Flight Manual.

SECTION 7 - DESCRIPTION AND OPERATION

The Model 4300-4XX Electric Attitude Indicator incorporates a moving display that simulates the earth's horizon and provides the pilot with a real time visual indication of the aircraft pitch and roll attitude relative to the indicator symbolic airplane.

The 4300-4XX Electric Attitude Indicator offers the feature of a self-contained standby power source.

Anytime aircraft power is absent, selecting the STBY PWR button will put the unit into the standby power mode.

A warning circuit monitors the electrical voltage used to power the gyro. When the indicator is turned "OFF", or after the internal battery is discharged, the gyro warning flag comes into view.

**PILOT'S OPERATING HANDBOOK
AND
FAA APPROVED AIRPLANE FLIGHT MANUAL**

**SUPPLEMENT NO. 22
FOR
S-TEC ADF-650D SYSTEM**

This supplement must be attached to the Pilot's Operating Handbook and FAA Approved Airplane Flight Manual when the S-TEC ADF-650D System is installed per the equipment list. The information contained herein supplements or supersedes the Pilot's Operating Handbook and FAA Approved Airplane Flight Manual only in those areas listed herein. For limitations, procedures, performance and loading information not contained in this supplement, consult the Pilot's Operating Handbook and FAA Approved Airplane Flight Manual.

FAA APPROVED:



LINDA J. DICKEN
DOA-510620-CE
THE NEW PIPER AIRCRAFT, INC.
VERO BEACH, FLORIDA

DATE OF APPROVAL: SEPTEMBER 12, 2005

SECTION 1 - GENERAL

This supplement supplies information necessary for the operation of the airplane when the S-TEC ADF-650D System is installed in accordance with FAA approved Piper data.

SECTION 2 - LIMITATIONS

No change.

SECTION 3 - EMERGENCY PROCEDURES

No change.

SECTION 4 - NORMAL PROCEDURES

To turn on the ADF-650D System:

- Depress the PWR button momentarily and release.

NOTE

If the PWR button is pressed for longer than 3 seconds, the receiver will immediately shut off.

- After successful self test, input desired station frequency and select ANT mode.
- Positively identify selected station or beacon.
- Adjust volume control as required.
- If ADF-650D System is used for navigation, select ADF or BFO mode immediately after the station has been positively identified.

To turn off the ADF-650D System:

- Depress the PWR button for at least 3 seconds.

NOTE

If the PWR button is released within 3 seconds, normal operations will resume.

SECTION 4 - NORMAL PROCEDURES (continued)

To perform the preflight checklist and self test:

- After successful self test, press the mode control until ANT is displayed and input a predetermined frequency to select a station in the immediate area. Adjust the volume control as necessary to provide a comfortable listening level.
- Press the ID button and observe that the station identification code becomes louder (if the station is voice-identified, it is not necessary to press the ID button).
- Press the ID button again to cancel the IDENT function and press the mode control until ADF is displayed.
- Observe the IND-650A Indicator and note that the bearing pointer indicates the relative bearing to the station.
- Push the TEST button while observing the indicator bearing pointer. The bearing pointer will rotate 90° and stop.
- Push the TEST button again (to turn off test function). The bearing pointer returns to the original relative bearing position.
- Switch to BFO mode, if appropriate, and verify a tone is present. Select the appropriate operating mode when all checks have been completed.

SECTION 5 - PERFORMANCE

No change.

SECTION 6 - WEIGHT AND BALANCE

Factory installed optional equipment is included in the licensed weight and balance data in Section 6 of the Pilot's Operating Handbook and Airplane Flight Manual.

SECTION 7 - DESCRIPTION AND OPERATION

The S-TEC ADF-650D System operates over a frequency range of 200 through 1799 kHz in 1-kHz increments. Three operating modes are included as part of the ADF-650D System.

- BFO
- ADF
- ANT

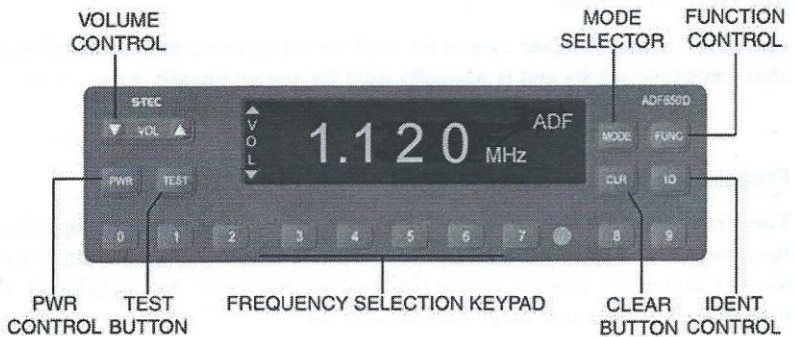

RCR-650D Receiver Controls

Beat Frequency Oscillator (BFO) Mode

The BFO (beat frequency oscillator) mode is used to aurally identify stations that employ keyed CW (Carrier Wave) rather than amplitude modulation techniques. This mode activates the bearing pointer. The bearing pointer will point in the direction of the station relative to the aircraft heading.

NOTE

CW signals (Morse Code) are unmodulated and no audio will be heard without use of BFO. This type of signal is not used in the United States air navigation. It is used in some foreign countries and marine beacons.

SECTION 7 - DESCRIPTION AND OPERATION (continued)

Automatic Direction Finder (ADF) Mode

The Automatic Direction Finder (ADF) mode uses conventional nondirectional beacons and AM broadcast stations for navigation. This mode activates the bearing pointer. The bearing pointer will point in the direction of the station relative to the aircraft heading.

Antenna (ANT) Mode

The ANT (antenna) mode cannot be used for navigation; this mode enhances audio reception clarity and is normally used for station identification.

Frequency Selection Keypad

The Frequency Selection Keypad is used to select the system operating frequency. The keypad consists of a row of numbered buttons from 0 to 9, located along the bottom of the RCR-650D Receiver. Frequencies in the megahertz and kilohertz range may be selected.

Power (PWR) Control

The power control is used to turn the receiver on and off. Momentarily depressing the PWR button will turn the receiver on and also initiate a self test.

NOTE

If the PWR button is pressed for longer than 3 seconds the receiver will immediately shut off.

SECTION 7 - DESCRIPTION AND OPERATION (continued)

Clear (CLR)

The clear function offers several options for the operator.

- If the entire frequency is entered and the CLR button is pushed, all the numbers will become dashes. An additional push on the CLR button will restore and display the prior frequency entry.
- If an entry is in progress and a number is entered in error, pressing the CLR button will erase the last number entry.
- Pressing the CLR button while in the contrast function reverses the display image and also places the receiver in manual mode.

NOTE

It is not necessary to push CLR to enter a new frequency number. Simply complete the entry and then enter the new numbers and they will replace the old frequency.

Volume (VOL) Control

The audio volume control is used to adjust the settings and levels for all function selector and setup modes and is controlled by pressing the **▲** and **▼** buttons on the VOL control.

SECTION 7 - DESCRIPTION AND OPERATION (continued)

Function (FUNC) Selector

The function selector enables the user to select between contrast and volume display functions (on power-up, the RCR-650D will be in the volume display function). The first time the function selector is pressed, the receiver enters the contrast function. Subsequent presses of the function selector button toggles the unit between contrast and volume. Additionally, pressing the clear button while in the contrast function places the receiver in manual mode. In manual mode, subsequent pushes of the function selector will cycle the receiver through four functions: volume, contrast, display and keypad.

- **Volume**



The volume control function is available on power-up and is accessed immediately by pressing the \blacktriangle and \blacktriangledown buttons on the VOL control. Upon activation, the kHz and mode annunciations are temporarily replaced by the text "VOLUME" with a horizontal fill bar. The filled portion of the bar indicates the current volume setting.

- **Contrast**



The contrast function is activated by pressing the FUNC selector. Upon activation, the kHz and mode annunciation are temporarily replaced by the text "CONTRAST" with a horizontal fill bar on the right side of the annunciator panel. The filled portion of the bar indicates the current contrast setting. The contrast is adjusted by pressing the appropriate \blacktriangle and \blacktriangledown indicators on the volume control.

- **Display**



When the display is setup in the manual mode, press the FUNC selector until the display function is selected. The display function is then activated and the kHz and mode annunciations are temporarily replaced by the text "DISPLAY" with a horizontal fill bar on the right side of the annunciator panel. The filled portion of the bar indicates the current display setting. The display is adjusted by pressing the appropriate \blacktriangle and \blacktriangledown indicators on the volume control.

SECTION 7 - DESCRIPTION AND OPERATION (continued)

Function (FUNC) Selector - continued

• Keypad Light Brightness



The keypad light brightness setting is used to adjust the brightness of all legends on the display face. When the display is setup in the manual mode, press the FUNC selector until the keypad function is selected. The keypad function is then displayed with the text "KEYPAD" and a horizontal fill bar on the right side of the annunciator panel. The filled portion of the bar indicates the current keypad brightness setting. The brightness is adjusted by pressing the appropriate \wedge and \vee indicators on the volume control.

Mode Selector



The mode selector is used to select one of the three operating states: BFO, ADF, or ANT. Pressing the MODE selector button will step the receiver through the three modes. The current mode will be displayed in the upper right corner of the display. On system power-up, the mode selector will be in the ADF mode.

Ident (ID)



The receiver utilizes an Ident Filter for audio output which aids in receiving weak signals. Pressing the ID button toggles the Ident Filter on and off. When the Ident Filter is active, the text "IDENT" is displayed in the bottom right corner of the display.

SECTION 7 - DESCRIPTION AND OPERATION (continued)

Test Mode



Press the TEST button to start the test mode. The text "TEST" will be displayed in the bottom right corner of the display for approximately 15 seconds. During this time, the IND-650A Indicator pointer will incrementally rotate 90°. Press the TEST button again to cancel the test while in this mode. The pointer will immediately return to its starting point.

**PILOT'S OPERATING HANDBOOK
AND
FAA APPROVED AIRPLANE FLIGHT MANUAL**

**SUPPLEMENT NO. 23
FOR
AVIDYNE FLIGHTMAX ENTEGRA
PRIMARY FLIGHT/MULTI-FUNCTION DISPLAYS
WITH
THE B&C SPECIALTIES BC410 STANDBY ALTERNATOR**

This supplement must be attached to the Pilot's Operating Handbook and FAA Approved Airplane Flight Manual when the optional Avidyne FlightMax Entegra Primary Flight and Multi-Function Displays with the B&C Specialties BC410 Standby Alternator is installed per the Equipment List. The information contained herein supplements or supersedes the basic Pilot's Operating Handbook and FAA Approved Airplane Flight Manual only in those areas listed herein. For limitations, procedures and performance information not contained in this supplement, consult the Pilot's Operating Handbook and FAA Approved Airplane Flight Manual.

FAA APPROVED:



LINDA J. DICKEN
DOA-510620-CE
THE NEW PIPER AIRCRAFT, INC.
VERO BEACH, FLORIDA

DATE OF APPROVAL: FEBRUARY 14, 2006

SECTION 1 - GENERAL

This airplane is equipped with the Avidyne FlightMax Entegra EXP5000 series 700-00006-0XX-() Primary Flight Display with 530-00138-000 software and EX5000 series 700-00004-0XX-() Multi-Function Display with 530-00137-000 software, herein referred to as the "PFD" and "MFD". The PFD is intended to be the primary display of primary flight and essential engine parameter information to the pilot. The PFD is capable of interfacing with a pair of Garmin GNS 430/530's, and an S-TEC System 55X autopilot.

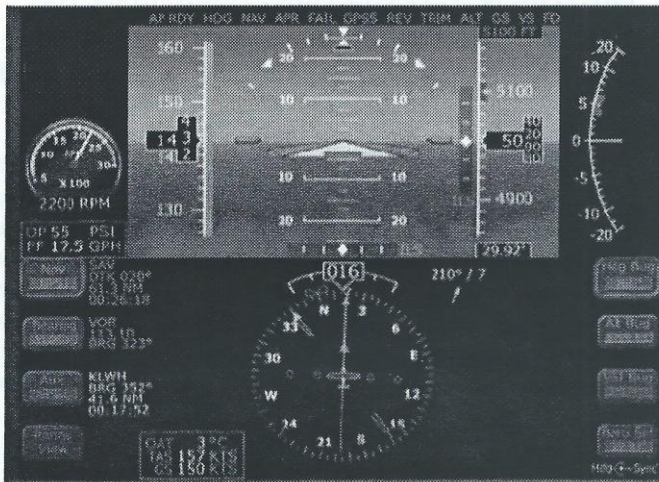

Figure 1 - Entegra 700-00006-0XX-() Primary Flight Display

The PFD provides the display of the following aircraft parameters:

- Artificial Horizon
- Airspeed Indication
- Altimeter
- Vertical Speed Indication
- Rate of Turn Indicator
- Skid/Slip Indicator
- Horizontal Situation Indication
- RMI
- Course Deviation Indication
- Outside Air Temperature
- Engine RPM
- Fuel Flow
- Oil Pressure
- Autopilot Annunciation

SECTION 1 - GENERAL (continued)

The MFD is intended to be a supplemental display of situational and navigation information to the pilot. Its primary function is to provide a moving map display to the pilot for increased situational awareness. The MFD is capable of accepting data from a variety of GPS sensors, the BFG WX-500 Stormscope passive thunderstorm detection unit, Engine Sensor Unit, and either the L3 Skywatch Traffic Advisory System (TAS), Bendix/King TAS, or the Ryan Traffic and Collision Alert Device (TCAD) system. The unit is organized around logical groupings of information presented on "Pages".

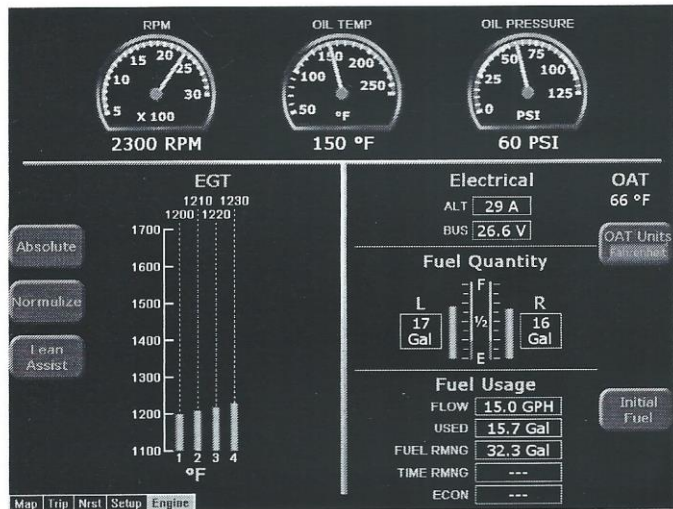

Figure 2 - EX5000 series 700-00004-0XX-() Multi-Function Display

The MFD provides the display of the following aircraft parameters:

- Engine RPM
- Engine Oil Temperature
- Engine Oil Pressure
- EGT
- Aircraft Electrical Status
- Outside Air Temperature
- Fuel Quantity
- Fuel Usage Data

SECTION 1 - GENERAL (continued)

A B&C Specialties, BC410 standby alternator, when ON, will automatically activate in the event of a failure in the primary alternator, therefore replacing the primary alternator function, but not supplementing its output. The alternator is gear driven through the engine vacuum pump drive pad.

The standby alternator is rated for 20 amperes of maximum load. The actual load available for use is dependent on engine rpm and current operating conditions.

SECTION 2 - LIMITATIONS**A. PFD Limitations**

1. IFR flight is prohibited when the PFD or any standby instrument is inoperative (altimeter, airspeed indicator, artificial horizon, or whiskey compass).
2. IFR flight is prohibited upon aircraft total loss of essential engine parameter display (manifold pressure, tachometer, fuel flow).
3. The Avidyne FlightMax Entegra series Primary Flight Display Pilot's Guide, p/n 600-00104-000 revision 00 or appropriate later revision, or p/n 600-00143-000 revision 01 (EXP 5000 R6) or appropriate later revision, must be available to the pilot during all flight operations.
4. If a VOR or Localizer (VLOC) navigation source is displayed on the HSI and GPSS mode is engaged on the autopilot, the autopilot will track the active flight plan in the GPS corresponding to the selected VLOC source selected for display on the HSI (i.e. GPS1 for VLOC1 or GPS2 for VLOC2). This configuration is potentially confusing and must be avoided.
5. GPSS mode must not be used on the final approach segment of a VLOC approach (ILS, LOC or non-GPS-overlay VOR). GPSS mode must be deselected (i.e., NAV mode selected) prior to the turn onto the final approach course.

NOTE

The PFD integrates with separately approved sensor and flight control installations. Adherence to limitations in appropriate installation AFM supplements is mandatory.

B. MFD Limitations

1. The Avidyne moving map display provides visual advisory of the airplane's GPS position against a moving map. This information supplements CDI course deviation and information presented on the GPS navigator. The moving map display must not be used as the primary navigation instrument.
2. Use of Map page during IFR flight requires an IFR approved GPS receiver and installation, operated in accordance with its applicable limitations.
3. The Avidyne FlightMax EX-series Pilot's Guide, p/n 600-00105-000 revision 00 or appropriate later revision, must be available to the pilot during all flight operations.

SECTION 2 - LIMITATIONS (continued)

B. MFD Limitations (continued)

4. Aircraft dispatch is prohibited when the MFD is inoperative.
5. Selecting "Lightning Display OFF" for the Lightning overlay of the Map page will prevent current heading values from being sent to the WX500 sensor from the EX5000.

When "Lightning Display OFF" is selected the EX5000 will stop sending current heading values to the WX500. When this selection is made, the WX500 will still use the last heading value that was present before this selection even though the actual aircraft heading may have changed since that selection was made.

Consequently, the Stormscope heading information provided to the Garmin 430 by the EX5000 will not be updated, resulting in an inaccurate lightning depiction on the Garmin 430. This issue does not affect the lightning display on the EX5000.

To avoid this invalid condition, **disable the WX500 on the GNS430**. For instructions on how to accomplish this, refer to the Garmin 400 Series Installation Manual, p/n 190-00140-02, latest revision (reference Section 5.1 Configuration Mode Operations, Section 5.2 Installation Configuration pages, and Section 5.2.2 Main RS232 Configuration page).

CAUTION

Traffic information shown on the Map page display is provided to the pilot as an aid to visually acquiring traffic. Pilot's should maneuver their aircraft based only on ATC guidance or positive visual acquisition of the conflicting traffic. Maneuvers should be consistent with ATC instructions. No maneuvers should be based only on a Traffic Advisory.

Terrain information shown on the Map page display is provided to the pilot as an aid to situational awareness. The Map page terrain color representations should not be used as a basis for terrain avoidance.

NOTE

The MFD integrates with separately approved sensor and flight control installations. Adherence to limitations in appropriate installation AFM supplements is mandatory.

SECTION 2 - LIMITATIONS (continued)**C. CMAX CHART PAGE Limitations**

The geographic referenced aircraft symbol must not be used for navigation.

NOTE

The aircraft symbol displayed provides supplemental aircraft situational awareness information. It is not intended as a means for navigation or flight guidance. The airplane symbol is not to be used for conducting instrument approaches or departures. Position accuracy, orientation, and related guidance must be assumed by other means or required navigation.

Operators with the optional CMax Chart Page must have back-up charts available. Do not rely upon CMax charts as your sole source of navigation information.

D. STANDBY ALTERNATOR Limitations

The standby alternator system is used in the event of primary alternator failure and not for normal operations.

The standby alternator is limited to 20 amperes continuous output. Transient operations of greater than 20 amperes for no more than 5 consecutive minutes may be conducted.

NOTE

Certain flight maneuvers such as climbs and lower power settings will result in an engine RPM less than 2500. Flight conditions resulting in less than 2500 engine RPM will reduce the standby alternator system capability and possibly require load shedding to maintain a system voltage above 25 volts.

SECTION 3 - EMERGENCY PROCEDURES

Failure of Pilot's Electronic Attitude Direction Display Screen (PFD)

Indication: PFD Display goes blank.

Standby Attitude Gyro**VERIFY ON and**
flag is pulled on gyro

Maintain attitude control using standby gyro and establish the aircraft in straight and level unaccelerated flight.

If time and conditions permit:

PFD Brightness Control (BRT/DIM)Run to full bright

PFD Circuit BreakerPULL and RESET

If PFD Screen cannot be reinstated:

On aircraft equipped with the optional second Nav Indicator (OBS):

Mechanical Nav Indicator (OBS).....Utilize for primary navigation

Engine Instruments.....Refer to Engine page of MFD

NOTE

The Mechanical Nav Indicator (OBS) receives nav information directly from the No. 2 nav/com/GPS. Only VLOC information is available.

Maintain attitude, airspeed and heading control using standby instruments, magnetic compass and other directional indications (such as MFD, MAP/NAV page).

CAUTION

High current loads in the vicinity of the magnetic compass can influence its accuracy. Depending on the flight conditions, the pilot must reduce these loads as much as possible to insure accuracy. Tests have shown that air conditioner and pitot heat contribute to significant heading errors of the magnetic compass. These items should be turned OFF prior to comparing magnetic compass headings.

Land as soon as practical.

SECTION 3 - EMERGENCY PROCEDURES (continued)

Loss of PFD Engine Data

Indication: Indicator needle removed from dial and digital readout replaced with white dashes.

Engine InstrumentsRefer to Engine page of MFD
Land as soon as practical.

Invalid Air Data

Indication: Airspeed, Altimeter, and Vertical Speed data replaced with Red X's.

Maintain aircraft airspeed and altitude by referring to the standby airspeed and altimeter.

If time and conditions permit:

PFD Circuit BreakerPULL and RESET

If air data is still invalid:

Refer to standby airspeed indicator and altimeter.

Land as soon as practical.

Invalid Heading Data

Indication: Heading Bug and Heading Data removed and replaced with Red X's.

If time and conditions permit:

PFD Circuit BreakerPULL and RESET

Maintain heading control using magnetic compass and other directional indications (such as MFD, MAP/NAV page).

CAUTION

High current loads in the vicinity of the magnetic compass can influence its accuracy. Depending on the flight conditions, the pilot must reduce these loads as much as possible to insure accuracy. Tests have shown that air conditioner and pitot heat contribute to significant heading errors of the magnetic compass. These items should be turned OFF prior to comparing magnetic compass headings.

Land as soon as practical.

SECTION 3 - EMERGENCY PROCEDURES (continued)

Invalid Attitude and Heading Data

Indication: Attitude and Heading Data removed and replaced with Red X's.

Standby Attitude Gyro **VERIFY ON** and
flag is pulled on gyro.

Maintain attitude control using standby gyro.

If time and conditions permit:

PFD Circuit Breaker **PULL** and **RESET**

If attitude and heading data is still invalid:

Maintain attitude control by using standby gyro.

Maintain heading control by utilizing magnetic compass and other directional indications (such as MFD, MAP/NAV page).

CAUTION

High current loads in the vicinity of the magnetic compass can influence its accuracy. Depending on the flight conditions, the pilot must reduce these loads as much as possible to insure accuracy. Tests have shown that air conditioner and pitot heat contribute to significant heading errors of the magnetic compass. These items should be turned OFF prior to comparing magnetic compass headings.

Land as soon as practical.

SECTION 3 - EMERGENCY PROCEDURES (continued)

Failure of Attitude, Airspeed and Heading Reference System (ADAHRS)

Indication: Airspeed, Attitude, Heading and Altitude replaced with Red X's.

Standby Attitude GyroVERIFY ON and
flag is pulled on gyro

Maintain attitude control using standby gyro.

If time and conditions permit:

PFD Circuit BreakerPULL and RESET

If ADAHRS initialization does not occur:

On aircraft equipped with the optional second Nav Indicator (OBS):

Mechanical Nav Indicator (OBS).....Utilize for primary navigation

Engine Instruments.....Refer to Engine page of MFD

NOTE

The Mechanical Nav Indicator (OBS) receives nav information directly from the No. 2 nav/com/GPS. Only VLOC information is available.

Maintain attitude, airspeed and heading control using standby instruments, magnetic compass and other directional indications (such as MFD, MAP/NAV page).

CAUTION

High current loads in the vicinity of the magnetic compass can influence its accuracy. Depending on the flight conditions, the pilot must reduce these loads as much as possible to insure accuracy. Tests have shown that air conditioner and pitot heat contribute to significant heading errors of the magnetic compass. These items should be turned OFF prior to comparing magnetic compass headings.

Land as soon as practical.

SECTION 3 - EMERGENCY PROCEDURES (continued)

Cross Check Monitor

Indication: Yellow Crosscheck Attitude Annunciator on PFD.

Establish aircraft in straight and level unaccelerated flight.

Aircraft AttitudeCrosscheck aircraft attitude
with standby attitude gyro

Total Loss of Engine Instruments

Indication: Indicator needle removed from dial and digital readout replaced with white dashes.

DAU Circuit BreakerPULL and RESET

If engine data is still invalid:

NOTE

The following engine messages will be displayed on the MFD if an exceedance is detected:

- Check Oil Temp
- Check Oil Press
- Check RPM
- Check EGT

If failure occurs during takeoff:

MixtureMaintain full rich
ThrottleFull power

Return to airport for landing.

If failure occurs during climb or landing:

MixtureMaintain full rich
Throttle.....As required

Land as soon as practical.

If failure occurs after setting cruise power and mixture:

PowerMaintain power setting

Land as soon as practical.

If failure occurs prior to or during descent:

MixtureFull rich
ThrottleSet for 500 feet per minute
descent at 122 KIAS

SECTION 3 - EMERGENCY PROCEDURES (continued)

ALTERNATOR FAILURE

Failure of Primary Alternator

Indication: Alternator Inop annunciator light illuminated and Standby Alternator ON annunciator light illuminated or zero current displayed on MFD alternator indication source.

NOTE

Anytime the bus voltage is below 25 Vdc, the Low Bus Voltage annunciator will be illuminated.

- STBY ALTRVerify ON/check ammeter indication
- Engine RPMIncrease to a minimum of 2500
- Electrical LoadReduce until total load is below 20 amps and/or low bus annunciator is extinguished

NOTE

If the STBY ALTR ON annunciator is flashing then reduce electrical loads until the annunciator no longer flashes.

NOTE

Certain flight maneuvers such as climbs and lower power settings will result in an engine RPM less than 2500. Flight conditions resulting in less than 2500 engine RPM will reduce the standby alternator system capability and possibly require load shedding to maintain a system voltage above 25 volts.

- ALTROFF
- ALTR FIELD circuit breakercheck and reset as required
- ALTRON

If primary alternator power not restored:

- ALTROFF

If primary alternator output cannot be restored, maintain an electrical load of less than 20 amps with which the STBY ALTR ON annunciator no longer flashes and *land as soon as practical.*

SECTION 3 - EMERGENCY PROCEDURES (continued)

ALTERNATOR FAILURE (continued)

Failure of Standby Alternator

If STBY ALTR ON is not illuminated:

STBY ALTROFF
STBY ALTR FIELD circuit breaker.....check and reset as required
STBY ALTR SENSE circuit breakercheck and reset as required
STBY ALTRON

If standby alternator power not restored:

STBY ALTROFF

If the standby alternator has failed or cannot provide adequate power, then electrical power is dependent on available battery storage. Duration of battery power available will be dependent on electrical load and battery condition prior to failure. Execute **Complete Electrical Failure** checklist when battery is depleted. *Land as soon as possible.*

WARNING

Compass error may exceed 10 degrees with alternator inoperative.

CAUTION

Any power interruption will result in loss of attitude information from the PFD until the unit can be reinstated on the ground.

NOTE

LO BUS VOLTAGE annunciator will be illuminated. Anticipate complete electrical failure. Duration of battery power available will be dependent on electrical load and battery condition prior to failure.

SECTION 3 - EMERGENCY PROCEDURES (continued)**ALTERNATOR FAILURE (continued)**

Reduce electrical loads by switching OFF or pulling circuit breakers for all non-essential equipment to include the following:

- Reduce PFD and MFD brightness as part of overall electrical system management
- Pitot heat (unless required)
- Airconditioner and ventilation fan (if installed)
- Landing light (use sparingly)
- Strobe lights
- Nav lights
- Recognition lights (if equipped)
- Cabin/flood lights
- No. 2 nav/com/GPS
- Autopilot (if equipped)
- Electric trim (if equipped)
- DME (unless required for published approach)
- Stormscope (if equipped)
- Skywatch (if equipped)

Land as soon as possible.

SECTION 3 - EMERGENCY PROCEDURES (continued)

Electrical Overload (Alternator over 20 amps above known electrical load)

ALTR.....ON
BATT MASTROFF

If alternator loads are reduced:

Electrical loadreduce to minimum

NOTE

Due to increased system voltage and radio frequency noise, operation with ALTR switch ON and BATT MASTR switch OFF should be made only when required by an electrical system failure.

If alternator loads are not reduced:

BATT.....ON
ALTOFF
STBY ALTRverify ON/check ammeter indication

NOTE

If the STBY ALTR ON annunciator is flashing then reduce electrical loads until the annunciator no longer flashes.

If the standby alternator has failed or cannot provide adequate power, then electrical power is dependent on available battery storage. Duration of battery power available will be dependent on electrical load and battery condition prior to failure. Execute **Complete Electrical Failure** checklist when battery is depleted.

WARNING

Compass error may exceed 10 degrees with alternator inoperative.

CAUTION

Any power interruption will result in loss of attitude information from the PFD until the unit can be reinstated on the ground.

NOTE

LO BUS VOLTAGE annunciator will be illuminated. Anticipate complete electrical failure. Duration of battery power available will be dependent on electrical load and battery condition prior to failure.

SECTION 3 - EMERGENCY PROCEDURES (continued)

Reduce electrical loads by switching OFF or pulling circuit breakers for all non-essential equipment to include the following:

- Reduce PFD and MFD brightness as part of overall electrical system management
- Pitot heat (unless required)
- Airconditioner and ventilation fan (if installed)
- Landing light (use sparingly)
- Strobe lights
- Nav lights
- Recognition lights (if equipped)
- Cabin/flood lights
- No. 2 nav/com/GPS
- Autopilot (if equipped)
- Electric trim (if equipped)
- DME (unless required for published approach)
- Stormscope (if equipped)
- Skywatch (if equipped)

Land as soon as practical.

SECTION 3 - EMERGENCY PROCEDURES (continued)

Complete Electrical Failure

Standby Attitude GyroSELECT Standby (STBY) power button

CAUTION

The STBY PWR annunciator will rapidly flash for approximately one minute when aircraft power is lost. STBY PWR must be selected, otherwise the gyro will auto shutdown after approximately one minute.

Standby Attitude GyroVERIFY ON and
flag is pulled on gyro

Maintain aircraft control with reference to the standby airspeed, altimeter, and attitude gyro indicators.

Battery SwitchOFF

Prior to descent:

MixtureFULL RICH

ThrottleSet for approx. 500 feet per
minute descent at 122 KIAS

Land as soon as possible.

WARNING

Compass error may exceed 10 degrees with alternator inoperative.

SECTION 3 - EMERGENCY PROCEDURES (continued)

Fire in Flight

Electrical Fire

- Fire.....Extinguish
- Battery Master Switch.....OFF
- ALTR Switch.....OFF
- STBY ALTR SwitchOFF
- Standby Attitude GyroSELECT Standby (STBY) power button

CAUTION

The STBY PWR annunciator will rapidly flash for approximately one minute when aircraft power is lost. STBY PWR must be selected, otherwise the gyro will auto shutdown after approximately one minute.

- Standby Attitude GyroVERIFY ON and
flag is pulled on gyro

Maintain aircraft control with reference to the standby airspeed, altimeter, and attitude gyro indicators.

- VentsOPEN
- Cabin HeatOFF

Prior to descent:

- MixtureFULL RICH
- ThrottleSet for approx. 500 feet per
minute descent at 122 KIAS

Land as soon as practical.

WARNING

Compass error may exceed 10 degrees with alternator inoperative.

SECTION 3 - EMERGENCY PROCEDURES (continued)

Aircraft Engine Power Loss

During an engine failure the pilot may elect to attempt an engine restart. During this time large voltage drops may cause the PFD to lose power and reinitialize. During this initialization process the PFD may not be able to complete a fast alignment during flight and therefore the pilot may have to obtain aircraft attitude and aircraft control using the standby instruments.

- Refer to the Emergency Section of the Pilot's Operating Handbook.
- If the PFD is able to perform fast alignment, when prompted by the PFD:
 - Maintain straight and level flight

OR

- If engine does not restart, maintain wings level and appropriate aircraft speed.
- Press the fast erect button.
- If the PFD was not able to perform fast alignment, maintain aircraft control with reference to the standby instruments for aircraft attitude information.

CAUTION

In case of engine failure, minimize the use of the starter and turn off all non-essential electrical equipment to preserve battery capacity.

NOTE

If standby alternator is installed, select OFF when primary alternator is OFF.

Loss of Fuel Flow

Electric Fuel PumpON
Fuel SelectorCheck on tank containing usable fuel

Engine Driven Fuel Pump Failure

ThrottleRETARD
Electric Fuel PumpON
Throttle.....RESET as required

CAUTION

If normal engine operation and fuel flow is not immediately re-established, the electric fuel pump should be turned OFF. The lack of fuel flow indication while the electric pump is on could indicate a leak in the fuel system or fuel exhaustion. If fuel system leak is verified, switch fuel selector to OFF.

Loss of Heading Accuracy

Indication:

- Difficulty maintaining course while using VOR or GPS.
- Excessive difference between heading and track required maintaining a VOR or GPS course.
- ATC indicates the aircraft is on a wrong heading.
- Excessive deviation between PFD heading and magnetic compass. (>10° after compass deviation applied.)

If heading systems differ by more than 10° (after compass deviation applied):

- Use magnetic compass for primary heading reference.

CAUTION

High current loads in the vicinity of the magnetic compass can influence its accuracy. Depending on the flight conditions, the pilot must reduce these loads as much as possible to insure accuracy. Tests have shown that air conditioner and pitot heat contribute to significant heading errors of the magnetic compass. These items should be turned OFF prior to comparing the magnetic compass to the PFD heading.

SECTION 4 - NORMAL PROCEDURES

Engine Start - General

CAUTION

Do not attempt flight if there is no indication of primary alternator output.

CAUTION

If a positive oil pressure is not indicated within 30 seconds following an engine start, stop the engine and determine the trouble. In cold weather it will take a few seconds longer to get a positive oil pressure indication.

NOTE

Starter manufacturers recommend that starter cranking periods be limited to 30 seconds with a two minute rest period between cranking periods. Longer cranking periods will shorten the life of the starter.

Before Starting Engine

PassengersBOARD
Door.....CLOSE and LATCH
SeatsADJUSTED and LOCKED in position
Seat Belts and HarnessesFASTEN/ADJUST
BrakesSET
Circuit Breakers.....Check IN
Carburetor HeatOFF
AvionicsOFF
Fuel Selector.....Desired tank

SECTION 4 - NORMAL PROCEDURES (continued)

Normal Start - Cold Engine

- Throttle¼ inch open
- Battery Master Switch.....ON
- Primary Flight Display (PFD)Verify correct aircraft
model software
- Alternator SwitchON
- Standby Alternator SwitchON
- Electric Fuel PumpON
- Left Magneto Switch.....ON
- Mixture.....Full RICH
- Propeller.....CLEAR
- StarterENGAGE
- Throttle.....ADJUST
- Right Magneto SwitchON
- Oil PressureCHECK

Normal Start - Hot Engine

- Throttle½ inch open
- Battery Master Switch.....ON
- Primary Flight Display (PFD)Verify correct aircraft
model software
- Alternator SwitchON
- Standby Alternator SwitchON
- Electric Fuel PumpON
- Left Magneto Switch.....ON
- MixtureIdle cut-off
- Propeller.....CLEAR
- StarterENGAGE
- Mixture.....ADVANCE
- Throttle.....ADJUST
- Right Magneto SwitchON
- Oil PressureCHECK

SECTION 4 - NORMAL PROCEDURES (continued)

Engine Start When Flooded

ThrottleOpen full
Battery Master Switch.....ON
Primary Flight Display (PFD)Verify correct aircraft
model software
Alternator SwitchON
Standby Alternator SwitchON
Electric Fuel PumpOFF
Left Magneto Switch.....ON
MixtureIdle cut-off
Propeller.....CLEAR
StarterENGAGE
MixtureFull rich
ThrottleRETARD
Right Magneto SwitchON
Oil PressureCHECK

SECTION 4 - NORMAL PROCEDURES (continued)

Starting With External Power Source

CAUTION

It is possible to use the ship's battery in parallel by turning only the battery master switch ON. This will give longer cranking capabilities, but will not increase the amperage. Care should be exercised because if the ship's battery has been depleted, the external power supply can be reduced to the level of the ship's battery. This can be tested by turning on the battery master switch momentarily while the starter is engaged. If cranking speed increases, the ship's battery is at a higher level than the external power supply.

NOTE

For all normal operations using external power, the battery master and alternator switches should be OFF.

- Battery Master SwitchOFF
- Alternator Switch.....OFF
- Standby Alternator Switch.....OFF
- Left Magneto Switch.....ON
- All Electrical EquipmentOFF
- External Power PlugInsert in fuselage
- Proceed with normal start checklist
- ThrottleLowest possible RPM
- Right Magneto SwitchON
- External Power PlugDisconnect from fuselage
- Battery Master Switch.....ON
- Alternator SwitchON - check ammeter
- Standby Alternator SwitchON
- Oil PressureCHECK

SECTION 4 - NORMAL PROCEDURES (continued)

Ground Check

- Throttlemaximum power/RP
- ALTR switchOF
- STBY ALTR ON annunciatorverify ON
- Increase electrical load to over 20 amps.
- STBY ALTR ON annunciatorverify flashing
- Decrease electrical load to less than 20 amps.
- STBY ALTR ON annunciatorverify ON (steady)
- Throttleretard
- ALTR switchON
- Verify normal amperage indication.
- STBY ALTR ON annunciatorverify extinguished

Taxiing

NOTE

During operations with low engine RPM, electrical system voltage may decrease below 26 volts, causing the STBY ALTR ON annunciator light to illuminate.

Before Takeoff

NOTE

Operation of the standby alternator with low engine RPM may cause an error in excess of 10° on the magnetic compass.

- STBY ALTR switchverify ON
- Throttleminimum 1000 RPM
- Magnetic Compasscheck with runway heading prior to takeoff

Stopping Engine

- STBY ALTR switchOFF

SECTION 5 - PERFORMANCE

No change from basic Handbook.

SECTION 6 - WEIGHT AND BALANCE

No change from basic Handbook.

SECTION 7 - DESCRIPTION AND OPERATION**A. PFD Systems Description****NOTE**

This supplement provides a general description of the Avidyne FlightMax Entegra Series 700-00006-0XX-() PFD, its operation, and aircraft systems interfaces. For a detailed description of PFD operation, refer to the Avidyne FlightMax Entegra Series Primary Flight Display Pilot's Guide, p/n 600-00104-000 revision 00 or appropriate later revision, or 600-00143-000 revision 01 (EXP 5000 R6) or appropriate later revision.

The Entegra PFD start-up is automatic once power is applied. The display presents the Initialization Display immediately after power is applied. Power-on default is 75% brightness. Typical alignment times are 3 minutes once power is applied.

Attitude Direction Indicator (ADI)Air Data

The airspeed tape to the left of the main ADI begins indicating at 20 Knots Indicated Airspeed (IAS) and is color coded in accordance with the model POH airspeeds for V_{SO} , V_{FE} , V_S , V_{NO} , and V_{NE} . An altitude tape is provided to the right of the main ADI and also displays a symbol for the Altitude Preselect (Altitude Bug). The Vertical Speed Indicator (VSI) is displayed to the right of the altitude tape. For vertical speed rates greater than the PFD displayed VSI scale, the indicator needle will peg just outside the scale and a digital readout of actual VSI up to 4000 FPM is then displayed. An additional data block is provided for display of Outside Air Temperature (OAT), True Airspeed (TAS), and Ground Speed (GS). Controls for selecting bug and barometric correction values are along the right side of the PFD. A wind indicator is also provided beneath the altitude tape.

Attitude Data

Attitude is depicted on the main ADI using a combination of an aircraft reference symbol ("flying-delta") against a background of labeled pitch ladders for pitch and a bank angle pointer in the form of an arced scale along the top of the main ADI for bank. A skid/slip indicator is attached to the bottom edge of the bank angle pointer.

SECTION 7 - DESCRIPTION AND OPERATION (continued)

A. PFD Systems Description (continued)

Horizontal Situation Indicator (HSI)

Heading Data

Magnetic heading is represented in a boxed digital form at the top of the compass rose. Heading rate (Rate of Turn Indicator) takes the form of a blue arcing arrow that begins behind the magnetic heading indicator and moves left or right accordingly. Graduations are provided on the rate of turn indicator scale to indicate ½ and full standard rate turns. A heading bug is also provided on the compass rose.

Navigation Data

Navigation data on the PFD takes several forms. A Course Deviation Indicator (CDI) is always provided on the HSI and a bearing pointer can be optionally selected for display on the HSI by the pilot. Controls for selecting the source of navigation data, selecting the display format of the navigation data, and for selecting the type of compass rose and moving map to be displayed are along the left side of the PFD. The active flight plan contained in the GPS Nav/Comm unit selected as the primary navigation source (Nav) can be optionally selected for display on the HSI as well as the desired range of the optionally selectable moving map display. If a localizer or ILS frequency is tuned and captured in the GPS Nav/Comm selected as the Nav source, a Vertical Deviation Indicator (VDI) and Horizontal Deviation Indicator (HDI) are automatically displayed on the ADI.

While executing an ILS or localizer only approach, the course deviation indicator (CDI) and glideslope needles on the PFD, as appropriate, may exhibit a slight oscillatory motion. The oscillatory motion increases from zero amplitude at approximately 2500 rpm to approximately ½ dot total amplitude at 2700 rpm. The GI-106 mechanical VOR Indicator needles exhibit this same behavior, only to a lesser degree. The pilot should fly the “average” localizer/glideslope needle position or decrease engine rpm to reduce needle oscillation.

NOTE

In the event glide slope or localizer signals are lost, the HDI and/or VDI will be displayed as red X's to indicate loss of signal. The red X'd indicator will only be removed if the signal is regained. In this case, the PFD Nav source will set to GPS, or if the GPS Nav/Comm is retuned, to another frequency. Appropriate action must be taken by the pilot if on an approach.

SECTION 7 - DESCRIPTION AND OPERATION (continued)**A. PFD Systems Description (continued)****Autopilot Integration**

The Entegra PFD is fully integrated with the S-TEC System 55X Autopilot. Reference bugs for Heading, Altitude, and Vertical Speed are provided on the PFD to control the autopilot and aid pilot situational awareness. These bugs are displayed with solid or hollow symbology depending on the autopilot status. If the autopilot is engaged in that mode, the bug is solid to indicate the autopilot is coupled to that bug. A hollow bug indicates the autopilot is not engaged in that mode.

Autopilot mode annunciations are shown on the S-TEC System 55X computer. When included as part of the installation, autopilot mode annunciations including autopilot ready and fail indications are provided at the top of the PFD screen.

When included as part of the installation, flight director command bars on the PFD attitude indicator can be enabled by the pilot. When the flight director is enabled and the autopilot is engaged in both lateral and vertical modes, the flight director displays the goals of the autopilot.

A lateral autopilot mode must be engaged on the S-TEC System 55X before a vertical mode can be engaged.

The flight director command bars will only be displayed on the PFD when enabled by the pilot and when both lateral and vertical autopilot modes are engaged.

SECTION 7 - DESCRIPTION AND OPERATION (continued)

A. PFD Systems Description (continued)

Autopilot Integration (continued)

The following autopilot modes are supported by the PFD:

1. HDG (Heading, using the heading bug)
2. NAV (Nav, using the course pointer and course deviation indicator)
3. GPSS (GPS Steering, using GPS course guidance)
4. APR (Approach, using the HDI and VDI, including automatic glide slope capture)
5. REV (Reverse sensing HDI approach)
6. ALT (Altitude Hold and Preselect, using the altitude bug)
7. VS (Vertical Speed, using the vertical speed bug)

NOTE

When HDG mode is engaged, rotation of the heading bug greater than 180° will result in a reversal of turn direction.

CAUTION

If a VLOC is selected in NAV on the PFD and GPSS mode is engaged on the autopilot, the autopilot will track the active flight plan in GPS1 if VLOC1 is selected or GPS2 if VLOC2 is selected and not track VLOC1 or VLOC2 as the selected source in NAV on the PFD. Therefore, the course deviation on the PFD CDI and the course deviation flown by the autopilot can be different. This situation may be confusing and should be avoided.

Engine Instruments

The Entegra PFD provides a display of Engine Tachometer (RPM), Oil Pressure (OP), and Fuel Flow (FF) in the upper left hand corner of the display. Tach indications are presented on analog scales with normal operating (green) and warning (red) markings, as appropriate. A digital indication presents fuel flow information in gallons per hour (GPH). A digital indication presents oil pressure information in pounds per square inch (PSI).

SECTION 7 - DESCRIPTION AND OPERATION (continued)

A. PFD Systems Description (continued)

Back-up Instruments

The Entegra PFD system installation includes redundant means of display of certain aircraft flight and systems parameters. Back-up Altimeter, Airspeed and Attitude instruments are provided to facilitate pilot cross-checking of PFD display flight parameters. The aircraft magnetic compass serves as a back-up heading source.

THIS SPACE INTENTIONALLY LEFT BLANK

SECTION 7 - DESCRIPTION AND OPERATION (continued)

B. MFD Systems Description

NOTE

This supplement provides a general description of the Avidyne EX5000 Series 700-00004-000-1 MFD, its operation and aircraft interface. For a detailed description of the MFD, refer to the Avidyne FlightMax EX5000 Series Pilot's Guide and Reference, p/n 600-00105-000 revision 00 or later.

Navigation

Data associated with the moving map is found on four pages: Map, Nearest, Trip, and Info pages. The MFD contains a Jeppesen NavData database that is available for display on the Map page. In conjunction with GPS-supplied position information, an own-ship symbol is superimposed on the moving map and positioned relative to the NavData information. GPS can also supply the active flight plan for display on the moving map. Terrain data is provided by a USGS terrain database stored within the MFD and updated only on an as needed basis.

The Jeppesen Navigation Database provides data on airports, approaches, VOR's, NDB's, intersections, airspace definitions, and frequencies. North American and international databases are available. Database information can be updated via the USB port on the front face of the bezel.

The navigation data on the moving map display are based on databases that are updated periodically. Database updates are available on 28-day cycle subscriptions. Expired databases are clearly stated to the pilot via messages during system startup and on the System Setup page. The warning can only be removed by updating the data.

NOAA man-made obstruction database information provides data on man-made obstacles over 200 feet AGL. This data is only available for North America and can be updated via the USB port on the front face of the bezel.

The obstacle data on the moving map display are based on databases that are updated periodically. Database updates are available from Avidyne on 56-day cycle subscriptions. Expired databases are clearly stated to the pilot via messages during system startup and on the System Setup page. The warning can only be removed by updating the data.

SECTION 7 - DESCRIPTION AND OPERATION (continued)**B. MFD Systems Description (continued)****Navigation (continued)**

Using the Jeppesen NavData data and the GPS-supplied present position, the MFD can provide the pilot with the nearest 25 airports or navaids, depending on pilot selection, within 100 nm. This information is presented on the Nearest page.

More detailed information on a particular airport is also generated from the Jeppesen NavData data and is available for pilot viewing on the Info page.

Flight plan data supplied by the GPS system provide the pilot with a tabular form of the remaining legs in the active GPS flight plan. This information is viewed on the Trip page and includes a CDI for added enroute navigation aiding.

Flight plan data is transmitted to the MFD from an external GPS navigator. Some installations do not support depictions of curved flight paths. In these cases, curved flight path segments will be depicted as straight lines. The GPS navigator and HSI are to be used during approach procedures. Reference the Avidyne FlightMax EX5000 Series Pilot's Guide, p/n 600-00105-000, for more information.

Datalink

Datalink information is received by the MFD based upon installation provisions and a subscription service available through Avidyne (www.myavidyne.com). Data is presented on the Map, Trip, and Nearest pages. Datalink information is provided for strategic planning purposes only. Data aging and transport considerations make it unsuitable for tactical use. Reference the Avidyne FlightMax EX5000 Series Pilot's Guide, p/n 600-00105-000, for more information.

Setup

The various System Setup pages allow the pilot to set user preferences for system operation. In addition to listing the software version identification information and database validity dates, the System Setup page allows access to several pages for preference selection and provides a means to initiate self-tests of the traffic and lightning sensors.

SECTION 7 - DESCRIPTION AND OPERATION (continued)

B. MFD Systems Description (continued)

Setup (continued)

Airport Settings page provides selections for displaying airport type, runway surface type and minimum runway lengths on the moving map. **Declutter Settings** page allows the pilot to select settings for defining the base map detail when changing display range. **System Time** page provides an opportunity to select system time zone and Map page menu timeout options. **DataBlock Edit** page allows the pilot to select the data to be displayed in the datablock windows on the Map page. **Datalink Setup** page allows the pilot to select parameters for the datalink system, including update rate and range of weather data request.

Engine Instruments

The Engine page provides the pilot with engine parameters depicted on simulated gauges and electrical system parameters located in dedicated regions within the MFD display. An Engine Sensor Unit interfaces with engine-mounted sensors and provides data to the MFD for display.

A leaning function assists the pilot in leaning the engine for best power or best fuel economy. To initiate the leaning function, press the Lean Assist bezel key and proceed to lean the engine fuel mixture. Best economy is achieved when the engine is operating at peak EGT of the leanest cylinder (first cylinder to peak), as recommended by the engine manufacturer. Best power is achieved when the engine is leaned to 100°F rich of its EGT peak. When leaning is complete, select Absolute or Normalize to complete the leaning process. A digital readout of EGT change from the peak value is provided for reference. Reference the Avidyne FlightMax EX5000 series Pilot's Guide, p/n 600-00105-000, for more information.

SECTION 7 - DESCRIPTION AND OPERATION (continued)**C. STANDBY ALTERNATOR System Description**

The B&C Specialty Products Standby Alternator system automatically delivers electrical power to the aircraft electrical power bus in the event of failure of the primary alternator, provided the STBY ALTR switch is in the ON position. Powering the bus allows the pilot flexibility to choose equipment suitable to the current flight conditions. Equipment that would otherwise deplete the battery reserve may be used within the standby alternator's current limit.

The standby alternator controller monitors the aircraft electrical power bus voltage and activates the standby alternator if the bus voltage falls to less than 26.0 volts. As long as the electrical load is maintained below standby alternator capacity, the bus voltage will not fall below 25.0 volts and the battery will remain charged. Certain flight maneuvers such as climbs and lower power settings will result in an engine RPM less than 2500. Flight conditions resulting in less than 2500 engine RPM will reduce the standby alternator system capability and possibly require load shedding to maintain a system voltage above 25 volts. As long as a minimum bus voltage of 25 volts is maintained, battery energy will then be available for landing lights and other approach loads.

The standard aircraft amperage indication represents the standby alternator output when the STBY ALTR ON annunciator is lit.

The standby alternator is capable of outputs greater than maximum continuous load for less than 5 minutes without damage. Extended operation over rated load may cause immediate or premature alternator failure and battery depletion.

NOTE

During operations with low engine RPM, electrical system voltage may decrease below 26 volts, causing the STBY ALTR ON annunciator light to illuminate.

THIS PAGE INTENTIONALLY LEFT BLANK

**PILOT'S OPERATING HANDBOOK
AND
FAA APPROVED AIRPLANE FLIGHT MANUAL**

**SUPPLEMENT NO. 24
FOR
BENDIX/KING KR-87 DIGITAL ADF
WITH KI-227 INDICATOR**

This supplement must be attached to the Pilot's Operating Handbook and FAA Approved Airplane Flight Manual when the Bendix/King KR-87 Digital ADF with the KI-227 Indicator is installed per the Equipment List. The information contained herein supplements or supersedes the Pilot's Operating Handbook and FAA Approved Airplane Flight Manual only in those areas listed herein. For limitations, procedures and performance information not contained in this supplement, consult the Pilot's Operating Handbook and FAA Approved Airplane Flight Manual.

FAA APPROVED:

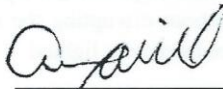

Albert J. Mill
DOA-510620-CE
Piper Aircraft, Inc.
Vero Beach, Florida

DATE OF APPROVAL: October 15, 2008

SECTION 1 - GENERAL

The Bendix/King Digital ADF is a panel mounted, digitally tuned, automatic direction finder. It is designed to provide continuous 1 kHz digital tuning in the frequency range of 200 kHz to 1799 kHz and eliminates the need for mechanical band switching. The system is comprised of a receiver, a built-in electronic timer, a bearing indicator and a KA-44B combined loop and sense antenna.

The Bendix/King Digital ADF can be used for position plotting and homing procedures, and for aural reception of amplitude modulated (AM) signals.

The "flip-flop" frequency display allows switching between pre-selected "STANDBY" and "ACTIVE" frequencies by pressing the frequency transfer button. Both preselected frequencies are stored in a non-volatile memory circuit (no battery power required) and displayed in self-dimming gas discharge numerics. The active frequency is continuously displayed in the left window, while the right window will display either the standby frequency or the selected readout from the built-in timer.

The built-in electronic timer has two separate and independent timing functions: (1) An automatic flight timer that starts whenever the unit is turned on. This timer functions up to 59 hours and 59 minutes. (2) An elapsed timer which will count up or down for up to 59 minutes and 59 seconds. When a preset time interval has been programmed and the countdown reaches :00, the display will flash for 15 seconds. Since both the flight timer and elapsed timer operate independently, it is possible to monitor either one without disrupting the other. The pushbutton controls and the bearing indicator are internally lighted.

SECTION 2 - LIMITATIONS

No change.

SECTION 3 - EMERGENCY PROCEDURES

No change.

SECTION 4 - NORMAL PROCEDURES

To Operate as an Automatic Direction Finder:

1. OFF/VOL Control - ON.
2. Frequency Selector Knobs - SELECT desired frequency in the standby frequency display.
3. FRQ Button - PRESS to move the desired frequency from the standby to the active position.
4. ADF SPEAKER/PHONE - Selector Switch (on audio control panel) - SELECT as desired.
5. OFF/VOL Control - SET to desired volume level.
6. ADF Button - SELECT ADF mode and note relative bearing on indicator.

ADF Test (Pre-flight or In-flight):

1. ADF Button - SELECT ANT mode and note pointer moves to 90° position.
2. ADF Button - SELECT ADF mode and note the pointer moves without hesitation to the station bearing. Excessive pointer sluggishness, wavering or reversals indicate a signal that is too weak or a system malfunction.

SECTION 4 - NORMAL PROCEDURES (continued)

NOTE

The Standby Frequency which is in memory while Flight Time or Elapsed Time modes are being displayed may be called back by pressing the FRQ button, then transferred to active use by pressing the FRQ button again.

To Operate Elapsed Time Timer-Count Down Mode:

1. OFF/VOL Control - ON.
2. FLT/ELT Mode Button - PRESS (once or twice) until ET is annunciated.
3. SET/RST Button - PRESS until the ET annunciation begins to flash.
4. FREQUENCY SELECTOR KNOBS - SET desired time in the elapsed time display. The small knob is pulled out to tune the 1's. The small knob is pushed in to tune the 10's. The outer knob tunes minutes up to 59 minutes.

NOTE

Selector knobs remain in the time set mode for 15 seconds after the last entry or until the SET/RST, FLT/ET, or FRQ button is pressed.

5. SET/RST Button - PRESS to start countdown. When the timer reaches 0, it will start to count up as display flashes for 15 seconds.

NOTE

While FLT or ET are displayed, the active frequency on the left side of the window may be changed, by using the frequency selector knobs, without any effect on the stored standby frequency or the other modes.

SECTION 4 - NORMAL PROCEDURES (continued)

ADF Operation NOTES:

Erroneous ADF Bearing Due to Radio Frequency Phenomena:

In the U.S., the FCC, which assigns AM radio frequencies, occasionally will assign the same frequency to more than one station in an area. Certain conditions, such as Night Effect, may cause signals from such stations to overlap. This should be taken into consideration when using AM broadcast station for navigation.

Sunspots and atmospheric phenomena may occasionally distort reception so that signals from two stations on the same frequency will overlap. For this reason, it is always wise to make positive identification of the station being tuned, by switching the function selector to ANT and listening for station call letters.

Electrical Storms:

In the vicinity of electrical storms, an ADF indicator pointer tends to swing from the station tuned toward the center of the storm.

Night Effect:

This is a disturbance particularly strong just after sunset and just after dawn. An ADF indicator pointer may swing erratically at these times. If possible, tune to the most powerful station at the lowest frequency. If this is not possible, take the average of pointer oscillations to determine relative station bearing.

Mountain Effect:

Radio waves reflecting from the surface of mountains may cause the pointer to fluctuate or show an erroneous bearing. This should be taken into account when taking bearings over mountainous terrain.

Coastal Refraction:

Radio waves may be refracted when passing from land to sea or when moving parallel to the coastline. This also should be taken into account.

SECTION 5 - PERFORMANCE

No change.

SECTION 6 - WEIGHT AND BALANCE

Factory installed optional equipment is included in the licensed weight and balance data in Section 6 of the Pilot's Operating Handbook and Airplane Flight Manual.

SECTION 7 - DESCRIPTION AND OPERATION

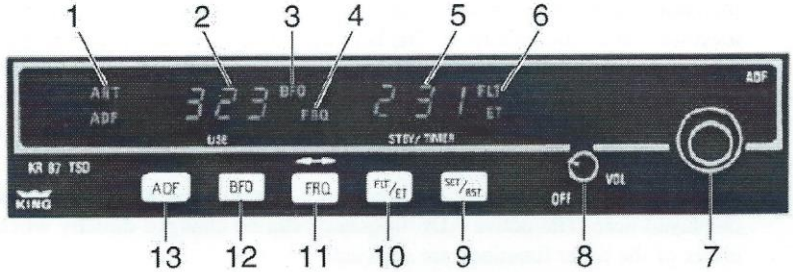

KR-87 Digital ADF

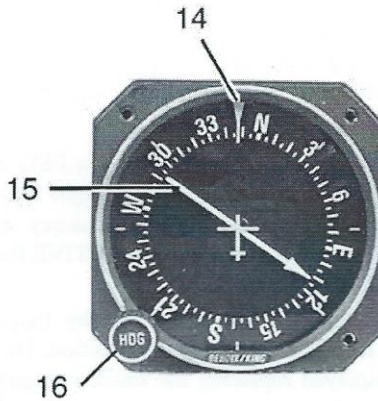

KI-227 Indicator

King Digital ADF Operating Controls and Indicators

Figure 1

SECTION 7 - DESCRIPTION AND OPERATION (continued)

Legend - Figure 1

1. Mode Annunciation - Antenna (ANT) is selected by the "out" position of the ADF button. This mode improves the aural reception and is usually used for station identification. The bearing pointer is deactivated and will park in the 90° relative position. Automatic Direction Finder (ADF) mode is selected by the depressed position of the ADF button. This mode activates the bearing pointer. The bearing pointer will point in the direction of the station relative to the aircraft heading.
2. Active Frequency Display - The frequency to which the ADF is tuned is displayed here. The active ADF frequency can be changed directly when either of the timer functions are selected.
3. Beat Frequency Oscillator (BFO) - The BFO mode, activated and annunciated when the "BFO" button is depressed, permits the carrier wave and associated morse code identifier broadcast on the carrier wave to be heard.

NOTE

CW signals (Morse Code) are unmodulated and no audio will be heard without use of BFO. This type of signal is not used in the United States air navigation. It is used in some foreign countries and marine beacons.

4. Standby Frequency Annunciation (FRQ) - When FRQ is displayed, the STANDBY frequency is displayed in the right hand display. The STANDBY frequency is selected using the frequency select knobs. The selected STANDBY frequency is put into the ACTIVE frequency window by pressing the frequency transfer button.
5. Standby Frequency Display - Either the standby frequency, the flight timer, or the elapsed time is displayed in this position. The flight timer and elapsed timer are displayed replacing the standby frequency which goes into "blind" memory to be called back at any time by depressing the FRQ button. Flight time or elapsed time are displayed and annunciated alternatively by depressing the FLT/ET button.

SECTION 7 - DESCRIPTION AND OPERATION (continued)**Legend - Figure 1 (continued)**

6. Timer Mode Annunciation - Either the elapsed time (ET) or flight time (FLT) mode is annunciated here.
7. Frequency Selector Knobs - Selects the standby frequency when FRO is displayed and directly selects the active frequency whenever either of the timer functions is selected. The frequency selector knobs may be rotated either clockwise or counterclockwise. The small knob is pulled out to tune the 1's. The small knob is pushed in to tune the 10's. The outer knob tunes the 100's with rollover into the 1000's. These knobs are also used to set the desired time when the elapsed timer is used in the countdown mode.
8. Off/Volume Control (OFF/VOL) - Controls primary power and audio output level. Clockwise rotation from OFF position applies primary power to receiver; further clockwise rotation increases audio level. Audio muting causes the audio output to be muted unless the receiver is locked on a valid station.
9. Set/Reset Button (SET/RST) - The set/reset button, when pressed, resets the elapsed timer whether it is being displayed or not.
10. Flight Time/Elapsed Time Mode Selector Button (FLT/ET) - The Flight Timer/Elapsed Time mode selector button, when pressed, alternatively selects either Flight Timer mode or Elapsed Timer mode.
11. Frequency Transfer Button (FRQ) - The FRQ transfer button, when pressed, exchanges the active and standby frequencies. The new frequency becomes active and the former active frequency goes into standby.
12. BFO Button - The BFO button selects the BFO mode when in the depressed position (see Note under item 3).
13. ADF Button - The ADF button selects either the ANT mode or the ADF mode. The ANT mode is selected with the ADF button in the out position. The ADF mode is selected with the ADF button in the depressed position.
14. Index (Rotatable Card) - Indicates relative, magnetic, or true heading of aircraft, as selected by the HDG control.

SECTION 7 - DESCRIPTION AND OPERATION (continued)

Legend - Figure 1 (continued)

15. Pointer - Indicates station bearing in degrees of azimuth, relative to the nose of the aircraft. When heading control is adjusted, indicates relative, magnetic, or true bearing of radio signal.
16. Heading Card Control (HDG) - Rotates card to set in relative, magnetic, or true bearing information.

**PILOT'S OPERATING HANDBOOK
AND
FAA APPROVED AIRPLANE FLIGHT MANUAL**

**SUPPLEMENT NO. 25
FOR
BENDIX/KING KN-63 DME**

This supplement must be attached to the Pilot's Operating Handbook and FAA Approved Airplane Flight Manual when the Bendix/King KN-63 DME is installed per the Equipment List. The information contained herein supplements or supersedes the Pilot's Operating Handbook and FAA Approved Airplane Flight Manual only in those areas listed herein. For limitations, procedures and performance information not contained in this supplement, consult the Pilot's Operating Handbook and FAA Approved Airplane Flight Manual.

FAA APPROVED:

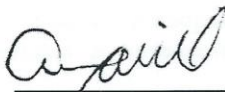

Albert J. Mill
DOA-510620-CE
Piper Aircraft, Inc.
Vero Beach, Florida

DATE OF APPROVAL: October 15, 2008

SECTION 1 - GENERAL

The Bendix/King KN-63 DME supplies continuous slant range distance information from a fixed ground station to an aircraft in flight.

The equipment consists of a KDI-572 Panel Display which contains all the operating controls and displays, and a remotely mounted KN-63 Receiver-Transmitter. The KDI-572 Panel Display digitally displays distances in nautical miles, ground speed in knots, and time to station in minutes. All displays are in self-dimming gas discharge numerics.

SECTION 2 - LIMITATIONS

No change.

SECTION 3 - EMERGENCY PROCEDURES

No change.

SECTION 4 - NORMAL PROCEDURES

DME Operation

1. DME Mode Selector Switch - SET to N1 or N2.
2. NAV 1 and NAV 2 VHF Navigation Receivers - ON; SET FREQUENCY selector switches to VOR/DME station frequencies, as required.

NOTE

When the VOR frequency is selected, the appropriate DME frequency is automatically channeled.

3. DME SPEAKER/PHONE selector buttons (on audio control panel) - SET to desired mode.

SECTION 5 - PERFORMANCE

No change.

SECTION 6 - WEIGHT AND BALANCE

Factory installed optional equipment is included in the licensed weight and balance data in Section 6 of the Pilot's Operating Handbook and Airplane Flight Manual.

SECTION 7 - DESCRIPTION AND OPERATION

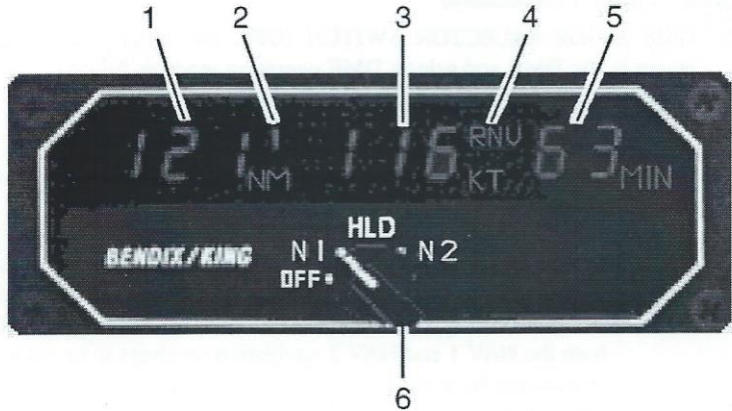

Bendix/King KN-63 DME

Figure 1

Legend - Figure 1

1. DISTANCE DISPLAY (NM) - DME distance to VORTAC/WAYPOINT displayed in .1 nautical mile increments up to 99.9 NM, then in increments of one nautical mile to 389 NM.
2. DME MODE ANNUNCIATOR - Displays the DME operating mode; NAV 1 (1); NAV 2 (2); NAV 1 HOLD (H1); NAV 2 HOLD (H2); of the mode selector switch (6).
3. GROUND SPEED DISPLAY (KT) - Displays ground speed in knots to or from VORTAC/WAYPOINT up to 999 knots (aircraft must be flying directly to or from the VORTAC/WAYPOINT for true ground speed indication).
4. RNAV ANNUNCIATOR (RNV) - Indicates RNV when displayed data is in relation to the RNAV waypoint. If the wrong DME mode is selected during RNAV operation, the RNAV annunciator will flash.
5. TIME-TO-STATION DISPLAY (MIN) - Displays time-to-station (VORTAC/WAYPOINT) in minutes up to 99 minutes (aircraft must be flying directly to or from the Vortac/Waypoint for true time-to-station indication).

SECTION 7 - DESCRIPTION AND OPERATION (continued)

Legend - Figure 1 (continued)

6. DME MODE SELECTOR SWITCH (OFF, N1, HLD, N2) - Applies power to the DME and selects DME operating mode as follows:

OFF: Turns DME power off.

NAV 1

(N1): Selects DME operation with No. 1 VHF navigation set; enables channel selection by NAV 1 frequency selector controls.

HOLD

(HLD): Selects DME memory circuit; DME remains channeled to station to which it was last channeled when HOLD was selected and will continue to display information relative to this channel. Allows both the NAV 1 and NAV 2 navigation receivers to be set to new operational frequencies without affecting the previously selected DME operation.

NOTE

In the HOLD mode there is no annunciation of the VOR/DME station frequency. However, an annunciator labeled "H1" or "H2" illuminates on the DME display to flag the pilot that the DME is in the HOLD mode.

NAV 2

(N2): Selects DME operation with No. 2 VHF navigation set; enables channel selection by NAV 2 frequency selector switches. Brightness of the labels for this switch is controlled by the RADIO light dimming rheostat.

**PILOT'S OPERATING HANDBOOK
AND
FAA APPROVED AIRPLANE FLIGHT MANUAL**

**SUPPLEMENT NO. 26
FOR
GARMIN G500 PRIMARY FLIGHT AND
MULTIFUNCTION DISPLAY SYSTEM**

The FAA approved operational supplement for the Garmin G500 PFD/MFD System, installed in accordance with STC SA02015SE-D, is required for operation of this system. Garmin will be responsible to supply and revise the operational supplement. It is permitted to include the Garmin G500 PFD/MFD supplement in this location of the Pilot's Operating Handbook unless otherwise stated by Garmin. The information contained in the Garmin G500 PFD/MFD supplement may supersede or supplement the information in the basic Pilot's Operating Handbook and FAA Approved Airplane Flight Manual with respect to the operation of the Garmin G500 PFD/MFD System. For limitations, procedures and performance information not contained in the Garmin supplement, consult the basic Pilot's Operating Handbook and FAA Approved Airplane Flight Manual.

THIS PAGE INTENTIONALLY LEFT BLANK

PILOT'S OPERATING HANDBOOK
AND
FAA APPROVED AIRPLANE FLIGHT MANUALSUPPLEMENT NO. 27
FOR
GARMIN GNS 430W VHF COMMUNICATION
TRANSCIVER/VOR/ILS RECEIVER/GPS RECEIVER

This supplement must be attached to the Pilot's Operating Handbook and FAA Approved Airplane Flight Manual when the Garmin GNS 430W VHF Communication Transceiver/VOR/ILS Receiver/Global Positioning System is installed per the Equipment List. The information contained herein supplements or supersedes the Pilot's Operating Handbook and FAA Approved Airplane Flight Manual only in those areas listed herein. For limitations, procedures and performance information not contained in this supplement, consult the Pilot's Operating Handbook and FAA Approved Airplane Flight Manual.

FAA APPROVED:

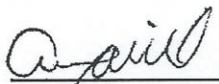
Albert J. Mill
ODA-510620-CE
Piper Aircraft, Inc.
Vero Beach, FloridaDATE OF APPROVAL: July 29, 2010ISSUED: JULY 12, 1995
REVISED: JULY 29, 2010REPORT: VB-1611
Page 1 of 12 • 9-205

SECTION 1 - GENERAL

The GNS430W System is a fully integrated, panel mounted instrument, which contains a VHF Communications Transceiver, a VOR/ILS receiver, and a WAAS-enabled Global Positioning System (GPS) Navigation computer. The system consists of a GPS antenna, GPS/WAAS receiver, VHF VOR/LOC/GS antenna, VOR/ILS receiver, VHF COMM antenna and a VHF Communications transceiver. The primary function of the VHF Communication portion of the equipment is to facilitate communication with Air Traffic Control. The primary function of the VOR/ILS Receiver portion of the equipment is to receive and demodulate VOR, Localizer, and Glide Slope signals. The primary function of the GPS/WAAS portion of the system is to acquire signals from the GPS system satellites, recover orbital data, make range and Doppler measurements, and process this information in real-time to obtain the user's position, velocity, and time.

Provided the GARMIN GNS 430W's GPS/WAAS receiver is receiving adequate usable signals, it has been demonstrated capable of and has been shown to meet the accuracy specifications for:

- GPS/WAAS TSO-C146a Class 3 Operation: The Garmin GNS430W uses GPS and WAAS (within the coverage of a Space-Based Augmentation System complying with ICAO Annex 10) for enroute, terminal area, non-precision approach operations (including "GPS" and "RNAV" approaches) and approach procedures with vertical guidance (including "LNAV/VNAV" and "LPV").

GPS navigation is accomplished using the WGS-84 (NAD-83) coordinate reference datum. GPS navigation data is based upon use of only the Global Positioning System (GPS) operated by the United States of America.

SECTION 1 - GENERAL (continued)**Class II Oceanic, Remote, and other operations**

The Garmin 430W has been found to comply with the requirements for GPS primary means of Class II navigation in oceanic and remote airspace when used in conjunction with Garmin Prediction Program part number 006-A0154-03. Oceanic operations are supported when the GNS430W unit annunciates OCN. This provides an alarm limit of four nautical miles and a mask angle of five degrees. The GNS430W unit also has the ability to predict RAIM availability at any waypoint in the database if WAAS corrections are expected to be absent or disabled. This does not constitute an operational approval for Oceanic or Remote area operations. Additional equipment installations or operational approvals may be required.

- Oceanic navigation requires an additional approved long range oceanic and/or remote area navigation system with independent display, sensors, antenna, and power source.
- Redundant VHF Com and VHF Nav systems may be required for other than US 14 CFR Part 91 operations. Check foreign regulation requirements as applicable.
- Operations approval may be granted for the use of the GNS430W unit RAIM prediction function in lieu of the Prediction Program for operators requiring this capability. Refer to your appropriate civil aviation authorities for these authorizations.

SECTION 2 – LIMITATIONS

Pilot's Guide

The Garmin 400W Series Pilot's Guide, part number and revision listed below (or later revisions), must be immediately available for the flight crew whenever navigation is predicated on the use of the GNS430W unit.

- 400W Series Pilot's Guide & Reference P/N 190-00356-00 Rev. B, or later revision.

This AFM supplement does not grant approval for IFR operations to aircraft limited to VFR operations. Additional aircraft systems may be required for IFR operational approval.

System Software

The system must utilize the Main and GPS software versions listed below (or later FAA approved versions for this installation). The software versions are displayed on the self-test page immediately after turn-on, for approximately 5 seconds, or they can be accessed on the AUX-UTILITY page.

Subsequent software versions may support different functions. Check the 400W Series Pilot's Guide for further information.

Approved Software Versions		
Software Item	Approved Software Version (or later FAA-approved versions)	
	Software Version	As Displayed on Unit
Main Software Version	3.0	3.0
GPS Software Version	3.0	3.0

Table 1

Navigation Data Base

The GNS430W unit database cards listed in the following table (or later FAA approved versions for this installation) must be installed.

- IFR enroute and terminal navigation is prohibited unless the pilot verifies the currency of the database or verifies each selected waypoint for accuracy by reference to current approved data.

SECTION 2 - LIMITATIONS (continued)**Navigation Data Base (continued)**

- GPS instrument approaches using the GNS430W are prohibited, unless the GNS430W's approach data is verified by the pilot or crew to be current. Instrument approaches must be accomplished in accordance with an approved instrument approach procedure that is loaded from the GNS430W's database.
- Installations with dual 430W units will only crossfill between those units when they contain the same database cycle. Updating of each database must be accomplished on the ground prior to flight.

Approved Navigation Database Cards

Part Number	Description
010-10546-00	Data Card, WAAS, IFR, World Wide
010-10546-01	Data Card, WAAS, IFR, Americas
010-10546-02	Data Card, WAAS, IFR, International

Table 2

SECTION 2 - LIMITATIONS (continued)

Terrain Data Base

The GNS430W supports Terrain and requires a Terrain database card to be installed in order for the feature to operate. The table below lists compatible database cards for the GNS430W. Each of the database cards contains the following data:

- The Terrain Database has an area of coverage from North 75° Latitude to South 60° Latitude in all longitudes.
- The Airport Terrain Database has an area of coverage that includes the United States, Canada, Mexico, Latin America, and South America.
- The Obstacle Database has an area of coverage that includes the United States, and is updated as frequently as every 56 days.

NOTE

The area of coverage may be modified as additional terrain data sources become available.

Approved Terrain Database Cards

Part Number	Description
010-10201-20	Data Card, TAWS / Terrain, 128MB
010-10201-21	Data Card, TAWS / Terrain, 256MB

Table 3

Navigation

No navigation is authorized north of 89° (degrees) north latitude or south of 89° (degrees) south latitude.

SECTION 2 - LIMITATIONS (continued)

Approaches

- During GPS approaches, the pilot must verify the GNS430W unit is operating in the approach mode. (LNAV, LNAV+V, L/VNAV, or LPV.)
- When conducting approaches referenced to true North, the heading selection on the AUX pages must be adjusted to TRUE.
- Accomplishment of an ILS, LOC, LOC-BC, LDA, SDF, MLS, VOR approach, or any other type of approach not approved for GPS overlay, is not authorized with GPS navigation guidance.
- Use of the GNS430W VOR/LOC/GS receiver to fly approaches not approved for GPS requires VOR/LOC/GS navigation data to be present on the external indicator (i.e. proper CDI source selection).

Terrain Display

Terrain refers to the display of terrain information. Pilots are NOT authorized to deviate from their current ATC clearance to comply with terrain/obstacle alerts. Terrain unit alerts are advisory only and are not equivalent to warnings provided by a Terrain Awareness and Warning System (TAWS). Navigation must not be predicated upon the use of the terrain display.

The terrain display is intended to serve as a situational awareness tool only. By itself, it may not provide either the accuracy or the fidelity on which to base decisions and plan maneuvers to avoid terrain or obstacles.

VNAV

VNAV information may be utilized for advisory information only. Use of VNAV information for instrument Approach Procedures does not guarantee Step-Down Fix altitude protection, or arrival at minimums in a normal position to land.

SECTION 3 - EMERGENCY PROCEDURES

Emergency Procedures

No change.

Abnormal Procedures

- If the Garmin GNS430W GPS navigation information is not available, or is invalid, utilize other remaining operational navigation equipment installed in the airplane as appropriate. If the 430W loses GPS position and reverts to Dead Reckoning mode (indicated by the annunciation of "DR" in the lower left of the display), the moving map will continue to be displayed. Aircraft position will be based upon the last valid GPS position and estimated by Dead Reckoning methods. Changes in airspeed or winds aloft can affect the estimated position substantially. Dead Reckoning is only available in Enroute mode; Terminal and Approach modes do not support DR.
- If a "Loss of Integrity" (INTEG) message is displayed during:
 - Enroute/Terminal: continue to navigate using GPS equipment and periodically cross-check the GPS guidance to other approved means of navigation.
 - GPS Approach: GPS approaches are not authorized under INTEG - Execute missed approach or revert to alternate navigation.
- During a GPS LPV precision approach or GPS LNAV/VNAV approach, the 430W will downgrade the approach if the Horizontal or Vertical alarm limits are exceeded. This will cause the vertical guidance to flag as unavailable. The procedure may be continued using the LNAV only minimums.
- During any GPS approach in which precision and non-precision alarm limits are exceeded, the 430W will flag the lateral guidance and generate a system message "ABORT APPROACH loss of navigation". Immediately upon acknowledging the message the unit will revert to Terminal alarm limits. If the position integrity is within these limits, lateral guidance will be restored and the GPS may be used to execute the missed approach, otherwise alternate means of navigation should be utilized.

In an in-flight emergency, depressing and holding the Comm transfer button for 2 seconds will select the emergency frequency of 121.500 Mhz into the "Active" frequency window.

SECTION 4 - NORMAL PROCEDURES

Refer to the 400W Series unit Pilot's Guide defined in Section 2 - Limitations of this supplement for normal operating procedures. This includes all GPS operations, VHF COM and NAV, and Multi-Function Display (optional) information.

Although intuitive and user friendly, the GNS430W requires a reasonable degree of familiarity to prevent operations without becoming too engrossed at the expense of basic instrument flying in IMC and basic see-and-avoid in VMC. Pilot workload will be higher for pilots with limited familiarity in using the unit in an IFR environment, particularly without the autopilot engaged. Garmin provides excellent training tools with the Pilot's Guide and PC based simulator. Pilots should take full advantage of these training tools to enhance system familiarization. Use of an autopilot is strongly encouraged when using the GNS430W in IMC conditions.

Approaches with Vertical Guidance

The GNS430W supports three types of GPS approaches with vertical guidance: LPV approaches, LNAV/VNAV (annunciated as L/VNAV) approaches, and LNAV approaches with advisory vertical guidance (annunciated as LNAV+V). For LNAV approaches with advisory vertical guidance, the GNS430W will announce LNAV+V indicating vertical guidance is available. LNAV minimums will be controlling in this case.

NOTE

If flying an LPV or LNAV/VNAV approach, be prepared to fly the LNAV only approach prior to reaching the final approach fix (FAF). If the GPS integrity is not within vertical approach limits, the system will flag the vertical guidance. This may be announced by a downgrade to LNAV message.

For additional information on approaches with vertical guidance, refer to the 400W Series unit Pilot's Guide.

SECTION 4 - NORMAL PROCEDURES (continued)

Autopilot Operation

The Garmin GNS430W may be coupled to the STEC 55X Autopilot when operating as prescribed in the LIMITATIONS section of this supplement. For lateral guidance, the STEC 55X Autopilot may utilize GPSS or GPS Roll Steering in lieu of the analog deviation information. For autopilot operational instructions, refer to the FAA approved Flight Manual or Flight Manual Supplement for the autopilot.

Coupling the Autopilot during Approaches

The Garmin GNS430W supports analog and digital (GPSS) control interfaces to the STEC 55X Autopilot. The STEC 55X may use digital GPS roll steering commands (GPSS) during GPS enroute, terminal, and LNAV approach operations only. When switching between GPS and VLOC, the pilot should be aware that the autopilot will need to be re-engaged in GPSS or NAV/APR, depending on the CDI nav source last selected or the type of approach desired.

Autopilot coupling to GPS vertical guidance requires that the autopilot be engaged in an analog APR mode identical to coupling to an ILS. To capture the vertical guidance, the pilot may engage the autopilot in APR mode at any time when the GPS Glide Slope (VDI) becomes valid (displayed without a FLAG).

Should a missed approach be required per the published missed approach procedure, the autopilot must be engaged in GPSS mode for proper guidance.

CAUTION

Do not operate the autopilot in the approach (APR) mode when conducting the published missed approach procedure.

SECTION 4 - NORMAL PROCEDURES (continued)

WFDE Prediction Program

The Garmin WAAS Fault Detection and Exclusion (WFDE) Prediction Program is required for Remote/Oceanic operations.

The Prediction Program should be used in conjunction with the Garmin 400W/500W Simulator. After entering the intended route of flight in the Simulator flight plan, the pilot selects the FDE Prediction Program under the Options menu of the Simulator program.

For detailed information, refer to the WFDE Prediction Program instructions (190-00643-01). The availability of FDE is only required for Oceanic or Remote operations.

SECTION 5 - PERFORMANCE

No change.

SECTION 6 - WEIGHT AND BALANCE

No change.

SECTION 7 - DESCRIPTION AND OPERATION

See Garmin 400W Series unit Pilot's Guide for a complete description of the GNS430W unit.

THIS PAGE INTENTIONALLY LEFT BLANK

TABLE OF CONTENTS

SECTION 10

OPERATING TIPS

Paragraph No.		Page No.
10.1	General	10-1
10.3	Operating Tips.....	10-1

THIS PAGE INTENTIONALLY LEFT BLANK

SECTION 10

OPERATING TIPS

10.1 GENERAL

This section provides operating tips of particular value in the operation of Archer III.

10.3 OPERATING TIPS

- (a) Learn to trim for takeoff so that only a very light back pressure on the control wheel is required to lift the airplane off the ground.
- (b) The best speed for takeoff is about 57 KIAS under normal conditions. Trying to pull the airplane off the ground at too low an airspeed decreases the controllability of the airplane in the event of engine failure.
- (c) Flaps may be lowered at airspeeds up to 102 KIAS. To reduce flap operating loads, it is desirable to have the airplane at a slower speed before extending the flaps. The flap step will not support weight if the flaps are in any extended position. The flaps must be placed in the "UP" position before they will lock and support weight on the step.
- (d) Before attempting to reset any circuit breaker, allow a two to five minute cooling off period.
- (e) Before starting the engine, check that all radio switches, light switches and the pitot heat switch are in the off position so as not to create an overloaded condition when the starter is engaged.
- (f) Anti-collision lights should not be operating when flying through cloud, fog or haze, since reflected light can produce spacial disorientation. Strobe lights should not be used in close proximity to the ground such as during taxiing, takeoff or landing.

- (g) The rudder pedals are suspended from a torque tube which extends across the fuselage. The pilot should become familiar with the proper positioning of his feet on the rudder pedals so as to avoid interference with the torque tube when moving the rudder pedals or operating the toe brakes.
- (h) In an effort to avoid accidents, pilots should obtain and study the safety related information made available in FAA publications such as regulations, advisory circulars, Aviation News, AIM and safety aids.
- (i) Prolonged slips or skids which result in excess of 2000 ft. of altitude loss, or other radical or extreme maneuvers which could cause uncovering of the fuel outlet must be avoided as fuel flow interruption may occur when tank being used is not full.
- (j) Hand starting of the engine is not recommended, however, should hand starting of the engine be required, only experienced personnel should attempt this procedure. The magneto selector should be placed to "LEFT" during the starting procedure to reduce the probability of "kick back." Place the ignition switch to "BOTH" position after the engine has started.

SYSTEM 55 QUICK REFERENCE



Engage AP roll mode from ready (RDY). AP flies heading selected on D.G or HSI.

Push HDG + NAV, APR, or REV simultaneously for pilot selected angle of intercept.

Navigation intercept and track. NAV APR is automatic when a LOC freq. is selected on the nav receiver used for AP operation.

Allows Pilot to select high gain (same as LOC) for VOR or GPS approach.

For LOC back course inbound or outbound front course intercept and track.

NOTE: With HSI, always set course pointer to the inbound FRONT course heading for either front or back course approach.

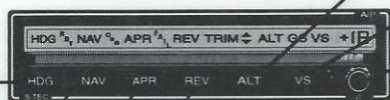

NOTE: CWS, HDG, NAV or REV mode must be engaged to engage any Pitch mode.

Engages Altitude Hold

Engages Vertical Speed.

Allows VS command in 100 ft. increments with VS knob.

Adjusts altitude up or down in 20 ft. increments in ALT mode (+/- 360 ft.)

NOTE: If optional ALT. Selector/Alerter is installed it must be off or in MAN mode to use VS knob for VS commands.

ADDITIONAL FEATURES/ANNUNCIATIONS

- RDY** Indicates system has passed self test and is ready to engage.
- CWS** Remote switch activation. From RDY mode or Autopilot modes, engages Autopilot (Roll and Pitch axis) synchronized with existing roll and pitch attitude WHEN RELEASED.
- FAIL** Indicates a) System did not pass self test on initial power-up.
b) NAV Warning Flag – VOR/LOC or GPS with Autopilot NAV mode engaged. NAV will flash.
c) GS Warning Flag with Autopilot GS mode engaged. GS will flash
- TRIM** Indicates Trim in motion OR trim required if Auto trim is off or inoperative.

Pressing NAV mode a second time when in NAV APR mode to disable GS coupling. GS will flash (no fail indication). Press again to restore.

To capture GS from above: a) Press ALT again IF already in ALT Mode.
b) If in VS mode, Press ALT then ALT again.

NOTE: To capture from above, GS must be valid (no flag) and localizer course deviation must be 50% or less.

ALTITUDE SELECTOR/ALERter QUICK REFERENCE

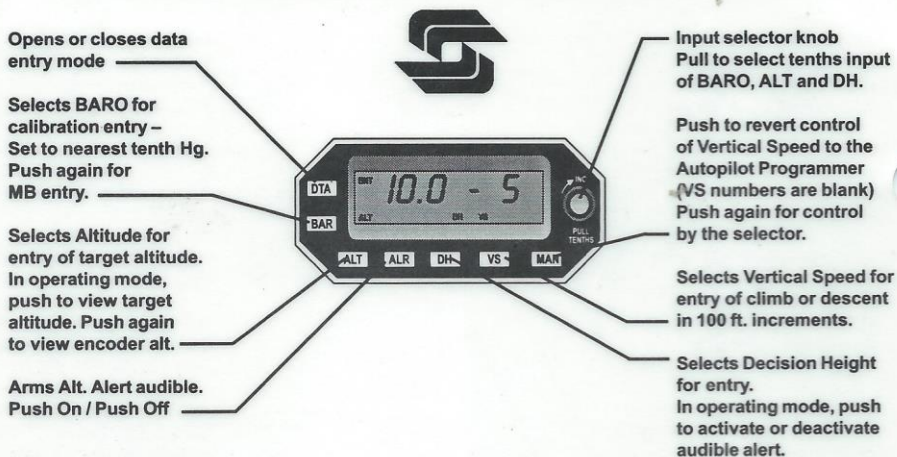

POINTS TO REMEMBER

- Set Barometric calibration, Altitude and / or Vertical Speed following initial power up self-test. System will be in data entry mode following self test.
- Push “DTA” to enter or change any data EXCEPT vertical speed –“VS”. Once entered, push “DTA” to close the entry mode or the unit can not communicate your input / settings to the autopilot.
- When “ENT” is displayed, the function flashing is the one selected for change or input. Once set, push “DTA” to close the data entry mode.
- To activate Pre-Selected ALTITUDE and VERTICAL SPEED, push BOTH the ALT and VS function buttons ON THE AUTOPILOT Programmer AT THE SAME TIME. This will be confirmed by both ALT and VS modes being annunciated on the AUTOPILOT PROGRAMMER.
- If “VS”, +/- and a number are not displayed, “MAN” mode has been selected and Vertical Speed commands must be input from the AUTOPILOT programmer. A target Altitude can still be pre-selected and the Autopilot “VS and “ALT” function buttons pushed at the same time to activate.
- For COMPLETE details of operation and additional features and functions, refer to the Pilot’s Operating Handbook for this product.
- If you are unsure of correct operation, it is always best to turn off the Altitude Selector / Alerter and revert to normal Autopilot operation.

MALONNIER LPS

Supplément au manuel de vol pour l'installation
d'un système malonnier de type LPS
sur l'avion Piper PA-28
en conformité avec la modification n°FA 37/2007

Les informations remplacent ou complètent celles du manuel de vol approuvé par
l'AESA, tel que défini ci-après.

Il est recommandé aux utilisateurs de se reporter systématiquement au supplément
afin de vérifier la présence éventuelle de mise à jour ainsi que le marquage des
indications applicables à l'utilisation de l'aéronef.

Ce manuel inclut les informations que les conditions de certification exigent de fournir
au pilote. Ceci ne constitue pas une autorisation opérationnelle.

N° et date d'approbation AESA

EASA . A.S . 03031

le 24/06/2008.

Page de révision

Révision n° : 0

Date : 25/10/2007

PAGES A DÉTRUIRE	PAGES A INSÉRER	DESCRIPTION DE LA RÉVISION

Sommaire

SECTION 1 - GENERALITES	3
SECTION 2 - LIMITATIONS	3
SECTION 3 - PROCEDURES D'URGENCE	3
SECTION 4 - PROCEDURES NORMALES.....	4
SECTION 5 - PERFORMANCES	6
SECTION 6 - MASSE ET CENTRAGE	6
SECTION 7 - DESCRIPTION	7

Section 1 - Généralités

Ce supplément est applicable au Piper PA-28. L'installation suivante et les critères opérationnels doivent être observés quand l'avion est équipé de la commande manuelle de direction et de frein «LPS».

Section 2 - Limitations

INSTALLATION

L'installation ou le démontage de la partie fixe de cette commande ne peut être effectué que par un **mécanicien habilité** à l'entretien des avions.

L'installation ou le démontage du bras de commande **démontable** peut être effectué par un **pilote convenablement formé et autorisé**.

Quand la poignée n'est pas en place, une protection doit être insérée dans l'extrémité de la partie fixe de la commande à main pour se protéger de tous contacts anormaux.

ATTENTION ! L'utilisation de cette commande exige une formation au sol et en vol

ATTENTION ! La partie démontable de la commande doit être enlevée pour tous vols sans pilote handicapé des membres inférieurs.

LIMITATIONS OPERATIONNELLES

Les jambes du pilote handicapé des membres inférieurs doivent être positionnées afin d'éviter la possibilité d'interférence avec les systèmes de commandes de vol de l'avion. Il s'agit de garantir les points suivants :

A/ pleins débattements du volant (les genoux doivent être suffisamment bas),

B/ le genou droit doit rester à gauche du plan vertical sur lequel se déplace la commande manuelle de dérive,

C/ pas de blocage des pédales de palonnier avec les pieds.

Pour satisfaire à ces conditions, sont adéquates :

- une position du siège réglé plutôt en arrière,
- ainsi qu'une sangle à scratch rapprochant les jambes au niveau des genoux.

ATTENTION ! L'amortisseur de shimmy de roue avant doit être entièrement opérationnel. Lorsqu'il y a du shimmy sur la roue avant le bras de commande peut blesser le pilote ou le passager du siège avant.

Section 3 - Procédures d'urgence

Pendant le roulage, si les vibrations se font sentir, réduire immédiatement la vitesse.

	SUPPLÉMENT AU MANUEL DE VOL		Révision : 2
			Du : 03/06/2008
		AFMS n° AFM-37-2007-000	Page 4 sur 7

Section 4 - Procédures normales

PREVOL

En sus de la procédure standard du manuel de vol, s'assurer de la bonne configuration des commandes manuelles additionnelles.

DEMARRAGE

Avant de commencer, le frein à main doit être mis solidement. Une attention particulière doit être faite pour garder les yeux à l'extérieur de l'avion afin de s'assurer de l'immobilité de l'avion.

ROULAGE AU SOL

Le roulage au sol s'effectue de la manière suivante :

- la main gauche reste en permanence sur la commande déportée de frein,
- un affichage de 1200 tours/min (+ ou - 100 trs/min : lors de la mise en mouvement de l'avion, et en fonction des pentes et revêtement des taxiways) est effectué puis la main droite agit sur la commande manuelle de dérive pour assurer le contrôle directionnel.
- l'action sur le frein (avec la main gauche) détermine la vitesse de roulage. Le frein à main doit être appliqué à basses vitesses. Pendant ce temps le volant peut être retenu avec un coude, mais aucune main ne le retient réellement.

Le rayon de braquage est légèrement plus grand dû au manque de freinage différentiel.

Au sol et en vol, se rappeler que :

La commande actionnée VERS LE HAUT la direction va vers la GAUCHE

La commande actionnée VERS LE BAS la direction va vers a DROITE

Apporter une attention particulière à ceci, jusqu'à ce que les mouvements deviennent automatiques.

POINT FIXE

Une attention supplémentaire est nécessaire pour avoir le frein à main serré pour que l'avion reste stationnaire tandis que la mise en puissance est effectuée jusqu'au niveau exigé.

Il est encore essentiel de faire un effort pour garder les yeux à l'extérieur pour s'assurer que l'avion n'avance pas.

Il est nécessaire de vérifier la friction de la manette des gaz afin qu'elle ne permette aucune variation de position notamment pendant la mise en puissance et la montée initiale.

DECOLLAGE

A/ Pendant la phase de mise en puissance, l'avion est maintenu aligné avec la main droite sur la commande manuelle de dérive, alors que la commande de puissance est ajustée par la main gauche.

B/ Quand la pleine puissance est appliquée, la main gauche est alors déplacée vers le volant de commande de vol. Des changements de pression très doux sur la commande manuelle sont suffisants pour maintenir l'avion aligné.

C/ Après la rotation, la main droite peut passer de la commande manuelle de dérive vers la commande des gaz pour maintenir la puissance désirée. Un ajustement du lacet peut être effectué au moyen du réglage de trim de direction.

Décollage court

A/ Une attention supplémentaire est exigée pour que le frein à main gauche soit maintenu pendant la mise en puissance.

B/ Après avoir affiché la pleine puissance, la main droite se déplace de la commande de gaz vers la commande manuelle de dérive en vue du contrôle de trajectoire de l'avion sur la piste.

C/ Enfin la main gauche libère le frein à main gauche, puis est immédiatement transférée du frein au volant de commande de vol.

D/ Les procédures normales de décollage court sont suivies.

Décollage par vents de travers

Pour un décollage par vent de travers, l'aile peut être maintenu dans le vent avec le coude au-dessus ou au-dessous du volant de commande de vol jusqu'à ce que la pleine puissance soit appliquée et que la main gauche retourne au volant de commande de vol afin que les procédures normales soient suivies.

ATTERRISSAGE

Normal

A/ L'approche est faite avec la main droite positionnée sur la commande de puissance jusqu'au début de l'arrondi.

B/ Afin d'alléger la charge de travail dans l'hypothèse d'une remise de gaz ou d'un toucher-décoller, deux actions sont à effectuer au passage des 300 pieds sol :

- la commande de réchauffe carburateur est actionnée avec la main droite de la position ON (en haut) vers le OFF (bas),
- le trim de direction est ajusté, à partir de sa position neutre, de deux rotations d'un quart de tour dans le sens horaire.

C/ A l'arrondi, la main droite actionne la manette des gaz sur plein réduit puis vient se positionner sur la commande manuelle de dérive pour la gestion de la trajectoire.

D/ Une fois l'avion au sol, la main droite reste en place sur la commande manuelle de dérive et la main gauche se déplace du volant vers le levier de frein déporté (à gauche du volant) jusqu'à très faible vitesse. La procédure « ROULAGE AU SOL » est ensuite appliquée.

Toucher Décoller

A/ B/ et C/ : idem « Atterrissage Normal »

D/ Pendant la phase de roulage, l'avion est contrôlé avec la main droite sur la commande manuelle de dérive tandis que la main gauche vient se positionner du volant vers la commande de puissance pour afficher plein régime et ensuite revenir se placer de nouveau sur le volant de commande de vol.

E/ Après la rotation, la main droite peut passer de la commande manuelle de dérive vers la commande des gaz pour maintenir la puissance désirée.

Atterrissage par vent de travers

Technique de coordination identique à celle décrite pour « l'Atterrissage Normale ». Notamment le point C/ : à l'arrondi, juste après avoir positionné la commande de puissance sur plein réduit avec la main droite, la correction de dérive et remise dans l'axe s'effectue à l'aide de cette même main droite alors transférée sur la commande manuelle de dérive.

Atterrissage court

Pas de consigne particulière liée au système additionnel « LPS » autre que celles qui sont rapportées dans le paragraphe « Atterrissage Normal »

Section 5 - Performances

La commande manuelle de direction n'a aucune influence sur les performances de l'appareil.

Section 6 - Masse et centrage

Partie fixe de la poignée de commande	= 1.3Kg	à	1230 mm
Partie démontable de la poignée de commande faisant partie de l'équipement du pilote	= 1.0 Kg		
Total des masses posées	= 2.3 Kg		

	SUPPLÉMENT AU MANUEL DE VOL	Révision : 2
		Du : 03/06/2008
AFMS n° AFM-37-2007-000		Page 7 sur 7

Section 7 - Description

La commande manuelle de direction est constituée de deux parties : la partie du bas, est fixée mécaniquement sur le palonnier droit de la place gauche, cette partie demeurant fixe.

La partie du haut démontable, qui lorsque est installée s'emboîte dans la partie du bas et est maintenue par deux goupilles à bille.

La commande manuelle de frein située à gauche du pilote est reliée directement à la commande de frein de parc d'origine

Ces deux commandes permettent au pilote installé en place gauche de manœuvrer la gouverne de direction de la main droite et d'actionner les freins de la main gauche. Ce système de commande utilisé permet, par un jeu de bras de levier, de diminuer les efforts à la commande manuelle par rapport à la commande aux palonniers.

La commande moteur se situe d'origine dans la partie centrale, proches de la commande manuelle de direction.

EMERGENCY PROCEDURES CHECK LIST SE-ILV

ENGINE FIRE DURING START

STARTER	CRANK ENGINE
MIXTURE	IDLE CUT OFF
THROTTLE	OPEN
ELECTRIC FUEL PUMP	OFF
FUEL SELECTOR	OFF

ENGINE POWER LOSS DURING TAKEOFF

FUEL SELECTOR	SWITCH TO TANK-FULL
ELECTRIC FUEL PUMP	CHECK ON
MIXTURE	CHECK RICH
CARBURATOR HEAT	ON

ENGINE POWER LOSS IN FLIGHT

AIRSPEED	MAINTAIN 76 KIAS
FUEL SELECTOR	SWITCH TO FULL TANK
ELECTRIC FUEL PUMP	ON
MIXTURE	RICH
CARBURATOR HEAT	ON

FIRE IN FLIGHT

SOURCE OF FIRE	CHECK
ELECTRICAL FIRE (SMOKE IN CABIN)	CHECK
BATT.MASTER SWITCH	OFF
ALTR SWITCH	OFF
VENTS	OPEN

LAND AS SOON AS POSSIBLE

ENGINE FIRE	
FUEL SELECTOR	OFF
THROTTLE	CLOSED
MIXTURE	IDLE CUT OFF
ELECTRIC FUEL PUMP	OFF
HEATHER AND DEFROSTER	OFF

LAND AS SOON AS POSSIBLE